

1W379

Silicon Variable Capacitance Diode for Electronic Tuning of BS and CS Tuners

Description

The 1W379 is a variable capacitance diode designed for the electronic tuning of BS and CS tuners, and it has a super miniature package.

Features

- Super miniature package
- Small series resistance 1.50 Ω Max. (f=470 MHz)
- Large capacitance ratio 12.0 Typ. (C₁/C₂₅)
- Small capacitance 0.60 pF Max. (V_R=25 V)

Structure

Silicon epitaxial planar-type diode

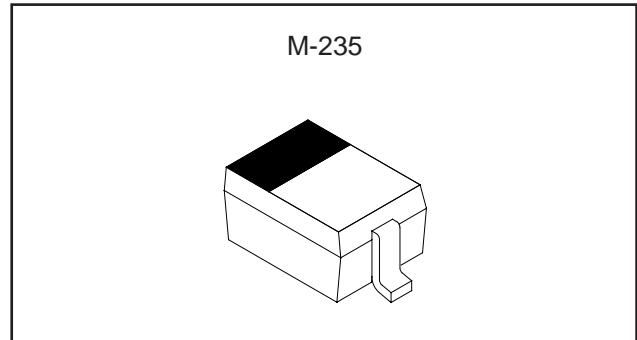

Absolute Maximum Ratings (T_a=25 °C)

- Reverse voltage V_R 30 V
- Maximum reverse voltage V_{RM} 35 V
(R_L≥10 k Ω)
- Operating temperature T_{opr} -20 to +75 °C
- Storage temperature T_{stg} -65 to +150 °C

Electrical Characteristics

(T_a=25 °C)

Item	Symbol	Conditions	Min.	Typ.	Max.	Unit
Reverse current	I _R	V _R =25 V			10	nA
Reverse voltage	V _R	I _R =1 μ A	30			V
Diode capacitance	C ₁	V _R =1 V, f=1 MHz	6.0		7.2	pF
	C ₂₅	V _R =25 V, f=1 MHz	0.5		0.6	pF
Capacitance ratio	C ₁ /C ₂₅	f=1 MHz	10.0	12.0		
Series resistance	r _s	V _R =5 V, f=470 MHz			1.50	Ω
Capacitance deviation in a matching group	Δ C	V _R =1 to 25 V, f=1 MHz			6	%

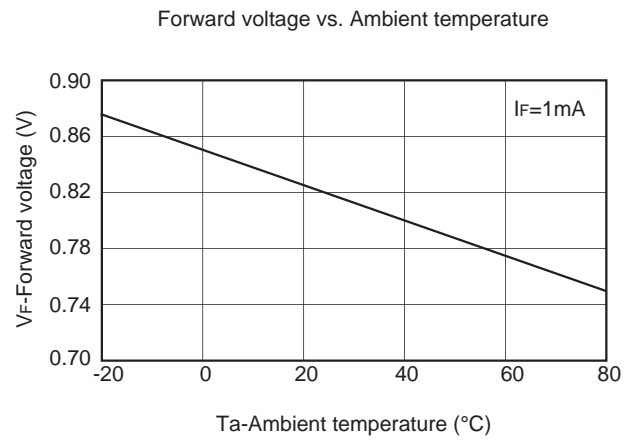
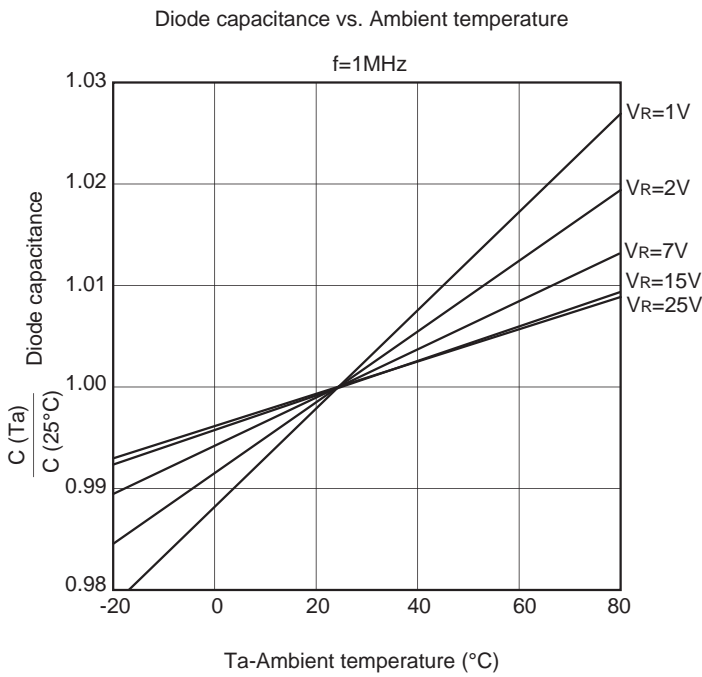
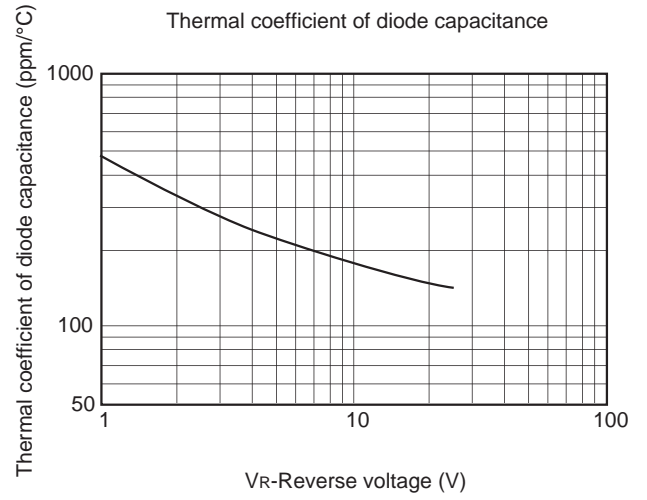
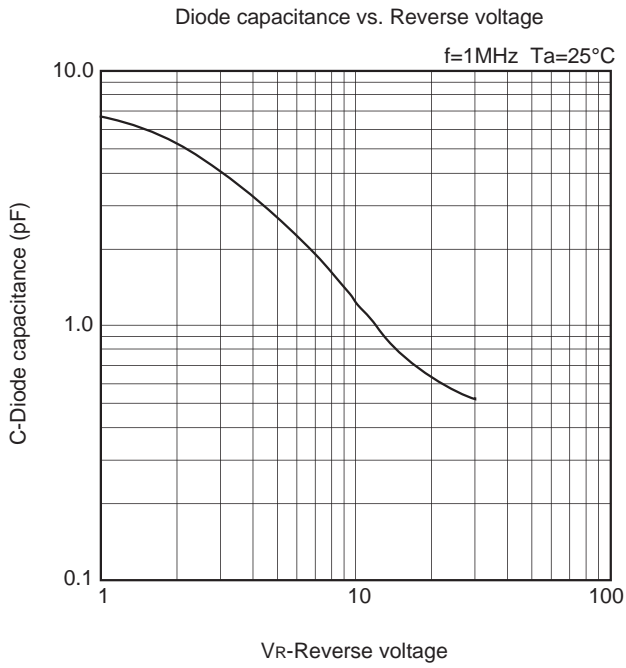

Reverse voltage vs. Ambient temperature

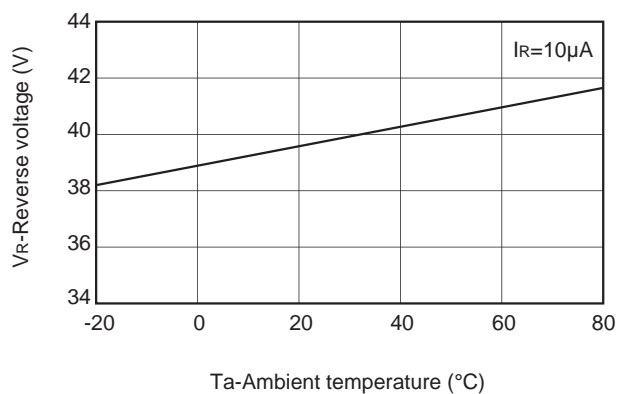

Reverse current vs. Ambient temperature

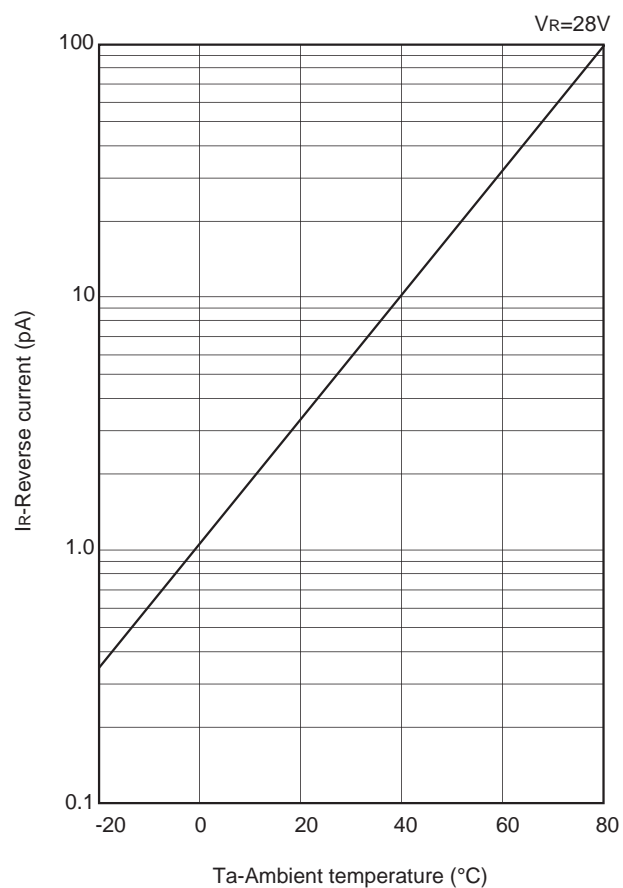

Reverse current vs. Reverse voltage

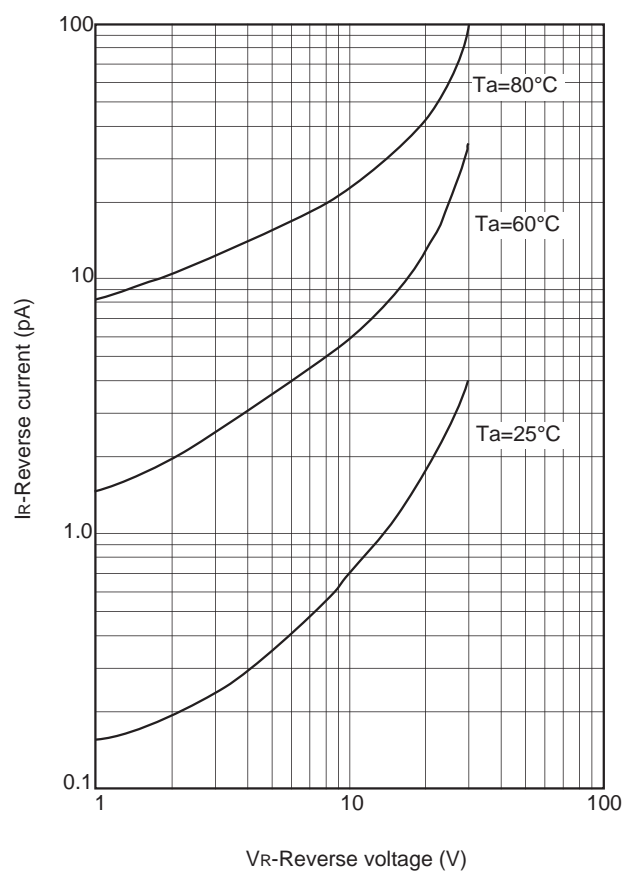

Package Outline Unit : mm

M-235

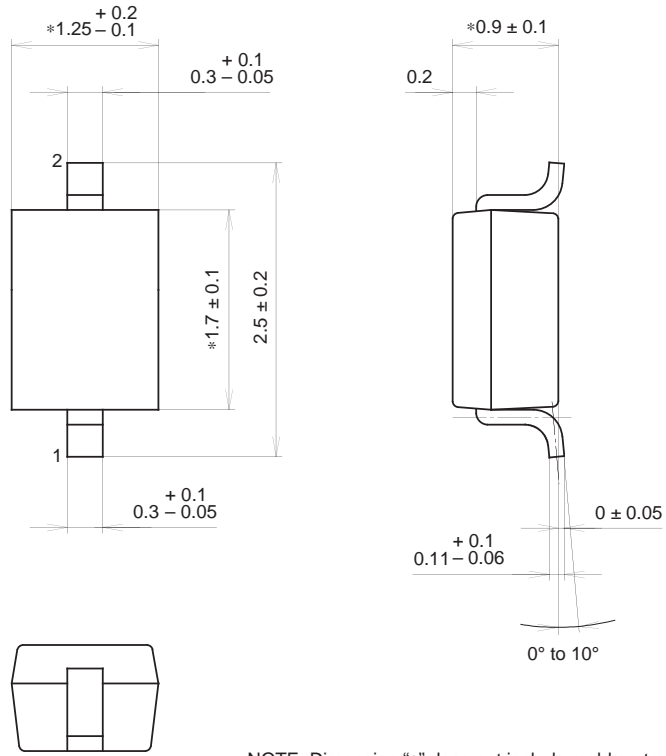

NOTE: Dimension "*" does not include mold protrusion.

PACKAGE WEIGHT	0.1g
----------------	------