

Dual General Purpose Transistors

The LMBT3946DW1T1 device is a spin-off of our popular SOT-23/SOT-323 three-leaded device. It is designed for general purpose amplifier applications and is housed in the SOT-363 six-leaded surface mount package. By putting two discrete devices in one package, this device is ideal for low-power surface mount applications where board space is at a premium.

- h_{FE} , 100-300
- Low $V_{CE(sat)}$, ≤ 0.4 V
- Simplifies Circuit Design
- Reduces Board Space
- Reduces Component Count
- Available in 8 mm, 7-inch/3,000 Unit Tape and Reel
- Device Marking: LMBT3946DW1T1G = 46

MAXIMUM RATINGS

Rating	Symbol	Value	Unit
Collector-Emitter Voltage (NPN) (PNP)	V_{CEO}	40 -40	Vdc
Collector-Base Voltage (NPN) (PNP)	V_{CBO}	60 -40	Vdc
Emitter-Base Voltage (NPN) (PNP)	V_{EBO}	6.0 -5.0	Vdc
Collector Current-Continuous (NPN) (PNP)	I_C	200 -200	mAdc
Electrostatic Discharge	E_{SD}	HBM>16000, MM>2000	V

THERMAL CHARACTERISTICS

Characteristic	Symbol	Max	Unit
Total Package Dissipation ⁽¹⁾ $T_A = 25^\circ\text{C}$	P_D	150	mW
Thermal Resistance Junction to Ambient	$R_{\theta JA}$	833	$^\circ\text{C/W}$
Junction and Storage Temperature Range	T_J, T_{stg}	-55 to +150	$^\circ\text{C}$

1. Device mounted on FR4 glass epoxy printed circuit board using the minimum recommended footprint.

LMBT3946DW1T1G

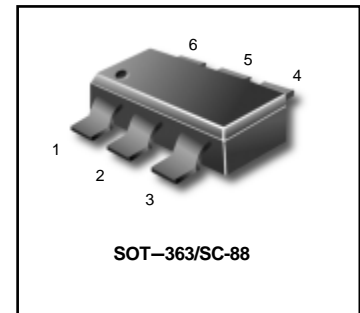

We declare that the material of product compliance with RoHS requirements.

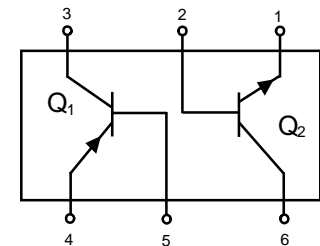

LMBT3946DW1T1*
*Q1 PNP
Q2 NPN

ORDERING INFORMATION

Device	Marking	Shipping
LMBT3946DW1T1G	46	3000Units/Reel
LMBT3946DW1T3G	46	10000Units/Reel

LMBT3946DW1T1G
ELECTRICAL CHARACTERISTICS($T_A=25^\circ\text{C}$ unless otherwise noted)

Characteristic	Symbol	Min	Max	Unit
OFF CHARACTERISTICS				
Collector–Emitter Breakdown Voltage ⁽²⁾	$V_{(BR)CEO}$			Vdc
($I_C = 1.0\text{ mAdc}$, $I_B = 0$) (NPN)		40	–	
($I_C = -1.0\text{ mAdc}$, $I_B = 0$) (PNP)		-40	–	
Collector–Base Breakdown Voltage	$V_{(BR)CBO}$			Vdc
($I_C = 10\ \mu\text{Adc}$, $I_E = 0$) (NPN)		60	–	
($I_C = -10\ \mu\text{Adc}$, $I_E = 0$) (PNP)		-40	–	
Emitter–Base Breakdown Voltage	$V_{(BR)EBO}$			Vdc
($I_E = 10\ \mu\text{Adc}$, $I_C = 0$) (NPN)		6.0	–	
($I_E = -10\ \mu\text{Adc}$, $I_C = 0$) (PNP)		-5.0	–	
Base Cutoff Current	I_{BL}			nAdc
($V_{CE} = 30\text{ Vdc}$, $V_{EB} = 3.0\text{ Vdc}$) (NPN)		–	50	
($V_{CE} = -30\text{ Vdc}$, $V_{EB} = -3.0\text{ Vdc}$) (PNP)		–	-50	
Collector Cutoff Current	I_{CEX}			nAdc
($V_{CE} = 30\text{ Vdc}$, $V_{EB} = 3.0\text{ Vdc}$) (NPN)		–	50	
($V_{CE} = -30\text{ Vdc}$, $V_{EB} = -3.0\text{ Vdc}$) (PNP)		–	-50	

ON CHARACTERISTICS (2)

DC Current Gain	h_{FE}			–
($I_C = 0.1\text{ mAdc}$, $V_{CE} = 1.0\text{ Vdc}$) (NPN)		40	–	
($I_C = 1.0\text{ mAdc}$, $V_{CE} = 1.0\text{ Vdc}$)		70	–	
($I_C = 10\text{ mAdc}$, $V_{CE} = 1.0\text{ Vdc}$)		100	300	
($I_C = 50\text{ mAdc}$, $V_{CE} = 1.0\text{ Vdc}$)		60	–	
($I_C = 100\text{ mAdc}$, $V_{CE} = 1.0\text{ Vdc}$)		30	–	
($I_C = -0.1\text{ mAdc}$, $V_{CE} = -1.0\text{ Vdc}$) (PNP)		60	–	
($I_C = -1.0\text{ mAdc}$, $V_{CE} = -1.0\text{ Vdc}$)		80	–	
($I_C = -10\text{ mAdc}$, $V_{CE} = -1.0\text{ Vdc}$)		100	300	
($I_C = -50\text{ mAdc}$, $V_{CE} = -1.0\text{ Vdc}$)		60	–	
($I_C = -100\text{ mAdc}$, $V_{CE} = -1.0\text{ Vdc}$)		30	–	
Collector–Emitter Saturation Voltage	$V_{CE(sat)}$			Vdc
($I_C = 10\text{ mAdc}$, $I_B = 1.0\text{ mAdc}$) (NPN)		–	0.2	
($I_C = 50\text{ mAdc}$, $I_B = 5.0\text{ mAdc}$)		–	0.3	
($I_C = -10\text{ mAdc}$, $I_B = -1.0\text{ mAdc}$) (PNP)		–	-0.25	
($I_C = -50\text{ mAdc}$, $I_B = -5.0\text{ mAdc}$)		–	-0.4	
Base–Emitter Saturation Voltage	$V_{BE(sat)}$			Vdc
($I_C = 10\text{ mAdc}$, $I_B = 1.0\text{ mAdc}$) (NPN)		0.65	0.85	
($I_C = 50\text{ mAdc}$, $I_B = 5.0\text{ mAdc}$)		–	0.95	
($I_C = -10\text{ mAdc}$, $I_B = -1.0\text{ mAdc}$) (PNP)		-0.65	-0.85	
($I_C = -50\text{ mAdc}$, $I_B = -5.0\text{ mAdc}$)		–	-0.95	

 2. Pulse Test: Pulse Width $\leq 300\ \mu\text{s}$; Duty Cycle $\leq 2.0\%$.

LMBT3946DW1T1G
ELECTRICAL CHARACTERISTICS ($T_A=25^\circ\text{C}$ unless otherwise noted)

Characteristic	Symbol	Min	Max	Unit
SMALL-SIGNAL CHARACTERISTICS				
Current-Gain – Bandwidth Product ($I_C = 10\text{ mAdc}$, $V_{CE} = 20\text{ Vdc}$, $f = 100\text{ MHz}$) (NPN)	f_T	300	–	MHz
($I_C = -10\text{ mAdc}$, $V_{CE} = -20\text{ Vdc}$, $f = 100\text{ MHz}$) (PNP)		250	–	
Output Capacitance ($V_{CB} = 5.0\text{ Vdc}$, $I_E = 0$, $f = 1.0\text{ MHz}$) (NPN)	C_{obo}	–	4.0	pF
($V_{CB} = -5.0\text{ Vdc}$, $I_E = 0$, $f = 1.0\text{ MHz}$) (PNP)		–	4.5	
Input Capacitance ($V_{EB} = 0.5\text{ Vdc}$, $I_C = 0$, $f = 1.0\text{ MHz}$) (NPN)	C_{ibo}	–	8.0	pF
($V_{EB} = -0.5\text{ Vdc}$, $I_C = 0$, $f = 1.0\text{ MHz}$) (PNP)		–	10.0	
Input Impedance ($V_{CE} = 10\text{ Vdc}$, $I_C = 1.0\text{ mAdc}$, $f = 1.0\text{ kHz}$) (NPN)	h_{ie}	1.0	10	k Ω
($V_{CE} = -10\text{ Vdc}$, $I_C = -1.0\text{ mAdc}$, $f = 1.0\text{ kHz}$) (PNP)		2.0	12	
Voltage Feedback Ratio ($V_{CE} = 10\text{ Vdc}$, $I_C = 1.0\text{ mAdc}$, $f = 1.0\text{ kHz}$) (NPN)	h_{re}	0.5	8.0	$\times 10^{-4}$
($V_{CE} = -10\text{ Vdc}$, $I_C = -1.0\text{ mAdc}$, $f = 1.0\text{ kHz}$) (PNP)		0.1	10	
Small-Signal Current Gain ($V_{CE} = 10\text{ Vdc}$, $I_C = 1.0\text{ mAdc}$, $f = 1.0\text{ kHz}$) (NPN)	h_{FE}	100	400	–
($V_{CE} = -10\text{ Vdc}$, $I_C = -1.0\text{ mAdc}$, $f = 1.0\text{ kHz}$) (PNP)		100	400	
Output Admittance ($V_{CE} = 10\text{ Vdc}$, $I_C = 1.0\text{ mAdc}$, $f = 1.0\text{ kHz}$) (NPN)	h_{oe}	1.0	40	μmhos
($V_{CE} = -10\text{ Vdc}$, $I_C = -1.0\text{ mAdc}$, $f = 1.0\text{ kHz}$) (PNP)		3.0	60	
Noise Figure ($V_{CE} = 5.0\text{ Vdc}$, $I_C = 100\text{ }\mu\text{Adc}$, $R_S = 1.0\text{ k}\Omega$, $f = 1.0\text{ kHz}$) (NPN)	NF	–	5.0	dB
($V_{CE} = -5.0\text{ Vdc}$, $I_C = -100\text{ }\mu\text{Adc}$, $R_S = 1.0\text{ k}\Omega$, $f = 1.0\text{ kHz}$) (PNP)		–	4.0	

SWITCHING CHARACTERISTICS

Delay Time	($V_{CC} = 3.0\text{ Vdc}$, $V_{BE} = -0.5\text{ Vdc}$) (NPN)	t_d	–	35	ns
	($V_{CC} = -3.0\text{ Vdc}$, $V_{BE} = 0.5\text{ Vdc}$) (PNP)		–	35	
Rise Time	($I_C = 10\text{ mAdc}$, $I_{B1} = 1.0\text{ mAdc}$) (NPN)	t_r	–	35	
	($I_C = -10\text{ mAdc}$, $I_{B1} = -1.0\text{ mAdc}$) (PNP)		–	35	
Storage Time	($V_{CC} = 3.0\text{ Vdc}$, $I_C = 10\text{ mAdc}$) (NPN)	t_s	–	200	ns
	($V_{CC} = -3.0\text{ Vdc}$, $I_C = -10\text{ mAdc}$) (PNP)		–	225	
Fall Time	($I_{B1} = I_{B2} = 1.0\text{ mAdc}$) (NPN)	t_f	–	50	
	($I_{B1} = I_{B2} = -1.0\text{ mAdc}$) (PNP)		–	75	

LMBT3946DW1T1G

TYPICAL ELECTRICAL CHARACTERISTICS
LMBT3946DW1T1G
(NPN)

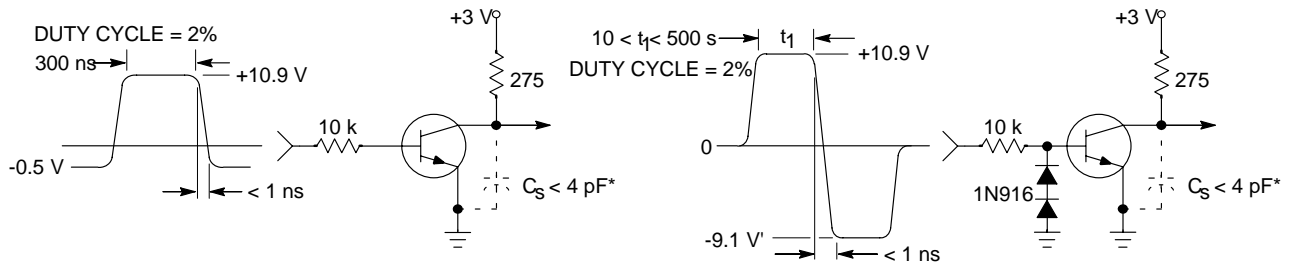

* Total shunt capacitance of test jig and connectors

Figure 1. Delay and Rise Time Equivalent Test Circuit

Figure 2. Storage and Fall Time Equivalent Test Circuit

TYPICAL TRANSIENT CHARACTERISTICS

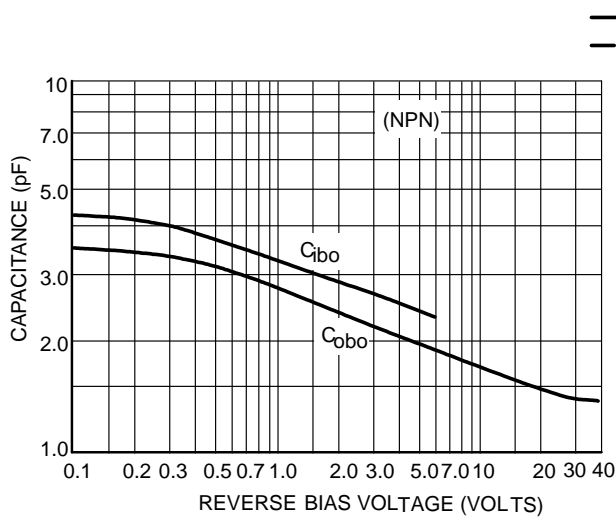

Figure 3. Capacitance

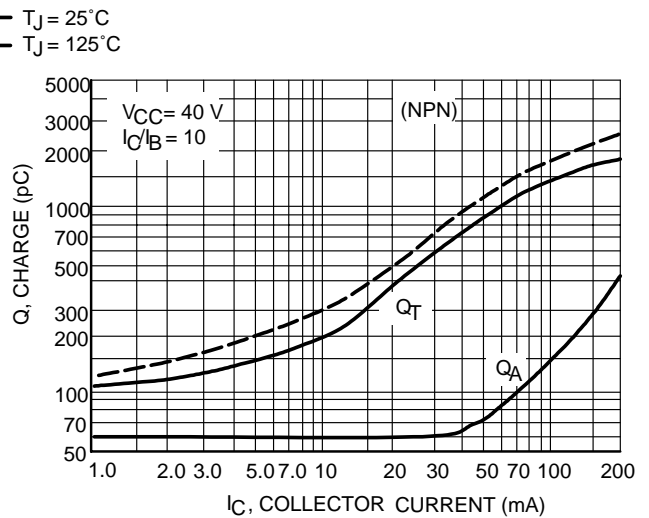

Figure 4. Charge Data

LMBT3946DW1T1G

TYPICAL ELECTRICAL CHARACTERISTICS

LMBT3946DW1T1G

(NPN)

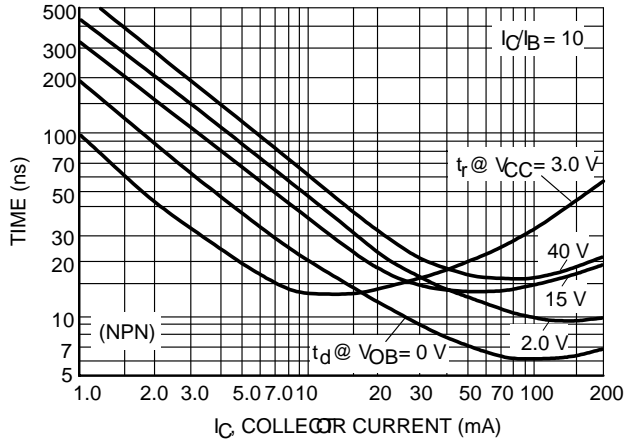

Figure 5. Turn-On Time

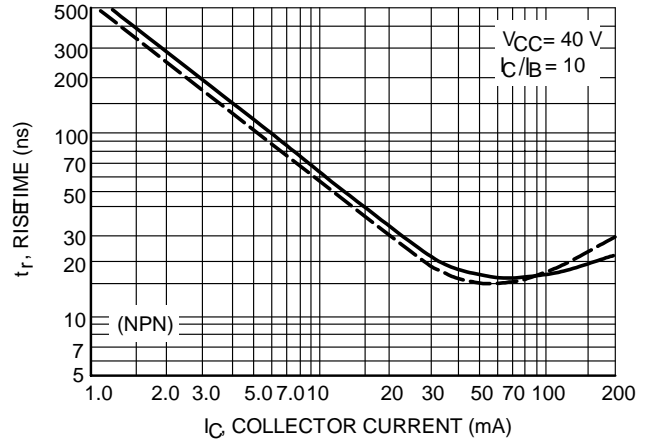

Figure 6. Rise Time

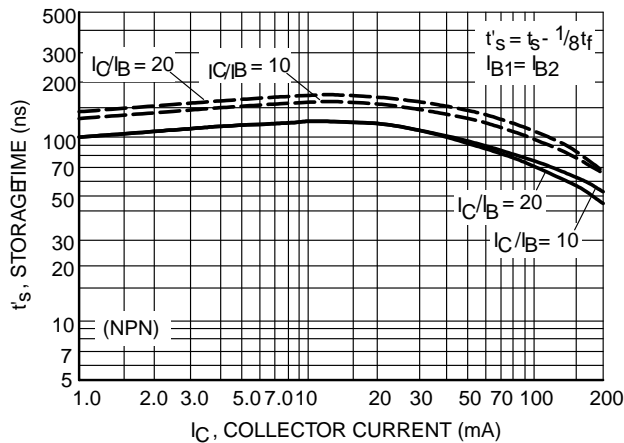

Figure 7. Storage Time

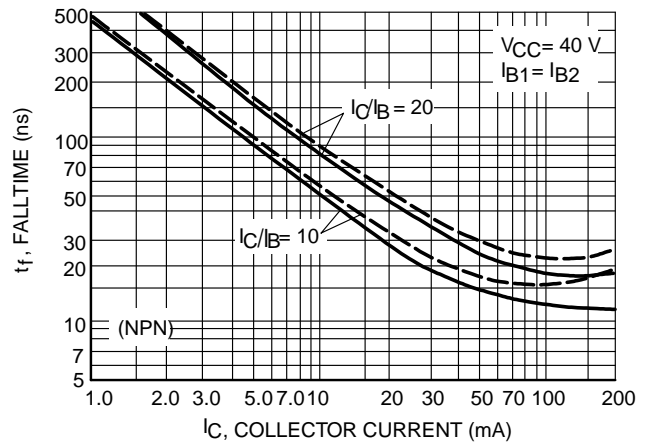

Figure 8. Fall Time

TYPICAL AUDIO SMALL-SIGNAL CHARACTERISTICS

NOISE FIGURE VARIATIONS

($V_{CE} = 5.0 \text{ Vdc}$, $T_A = 255^\circ\text{C}$, Bandwidth = 1.0 Hz)

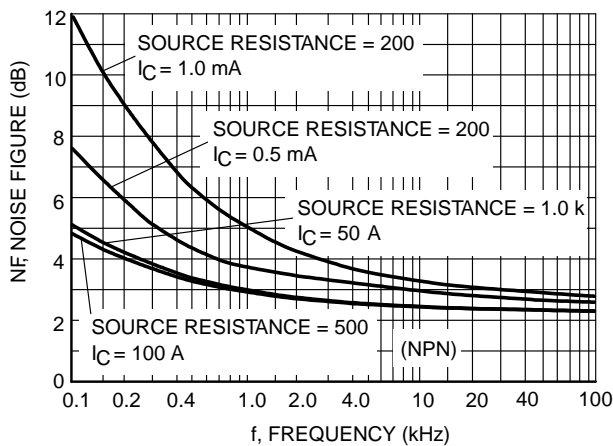

Figure 9. Noise Figure

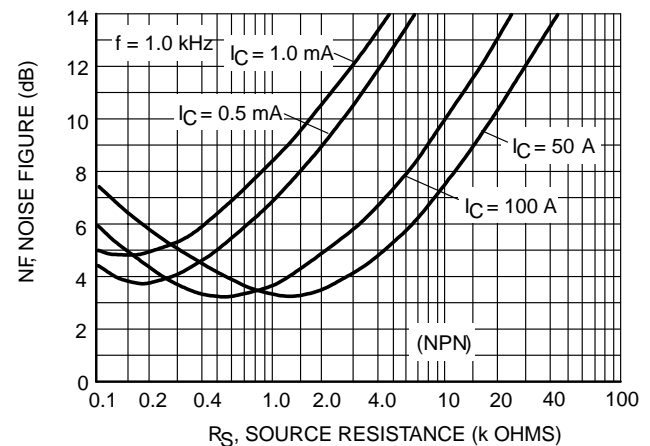

Figure 10. Noise Figure

LMBT3946DW1T1G

TYPICAL ELECTRICAL CHARACTERISTICS

LMBT3946DW1T1G

(NPN)

h PARAMETERS

($V_{CE} = 10 \text{ Vdc}$, $f = 1.0 \text{ kHz}$, $T_A = 25^\circ\text{C}$)

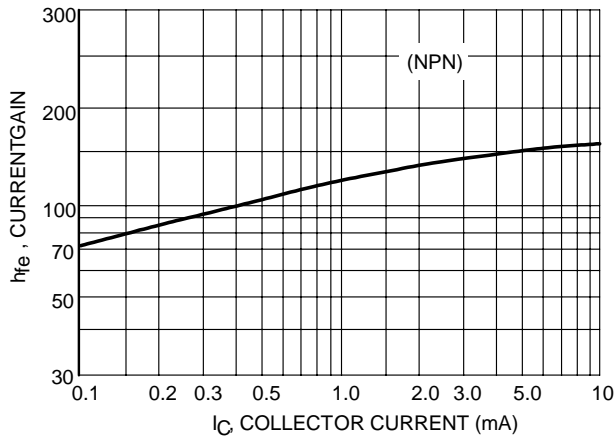

Figure 11. Current Gain

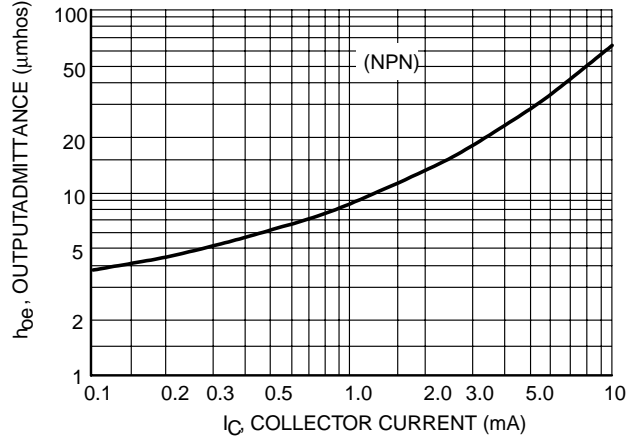

Figure 12. Output Admittance

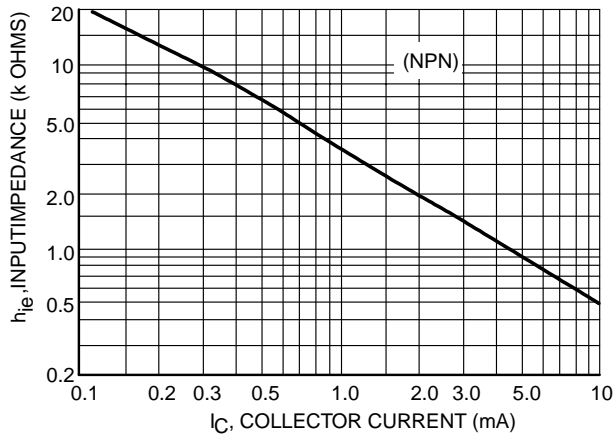

Figure 13. Input Impedance

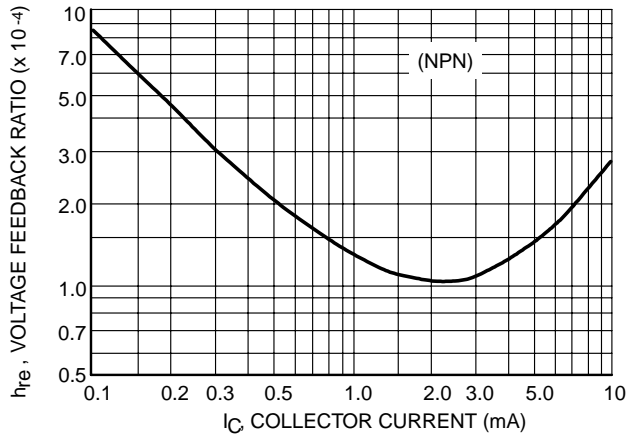

Figure 14. Voltage Feedback Ratio

LMBT3946DW1T1G

TYPICAL ELECTRICAL CHARACTERISTICS

LMBT3946DW1T1G

(NPN)

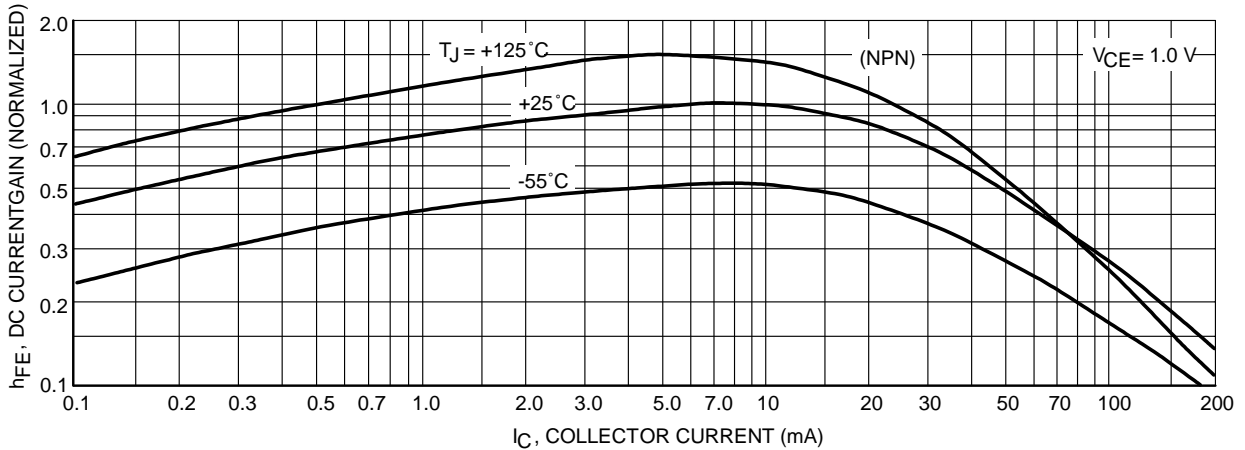

Figure 15. DC Current Gain

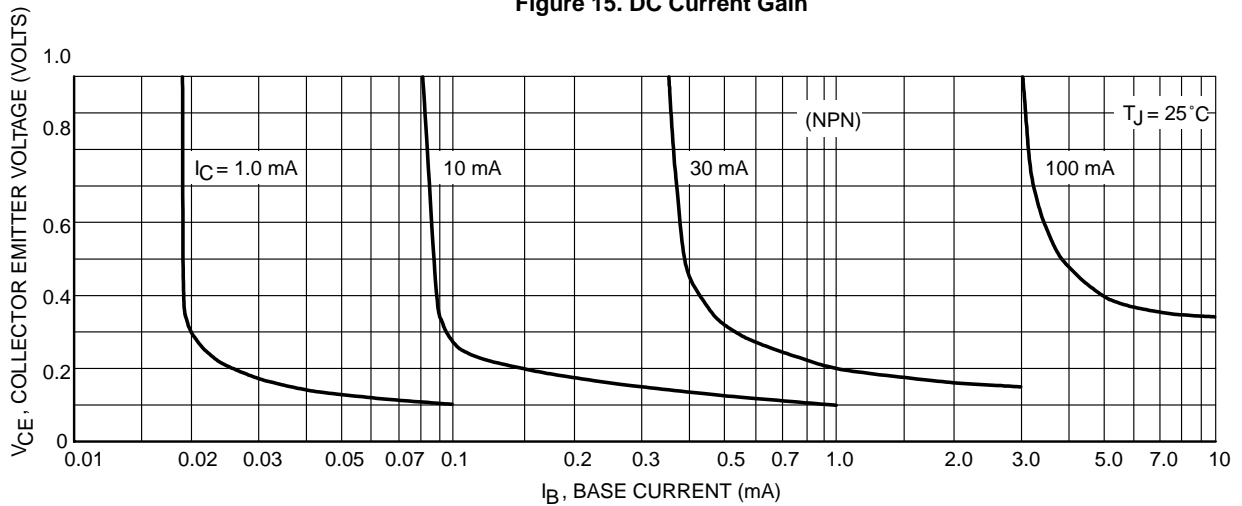

Figure 16. Collector Saturation Region

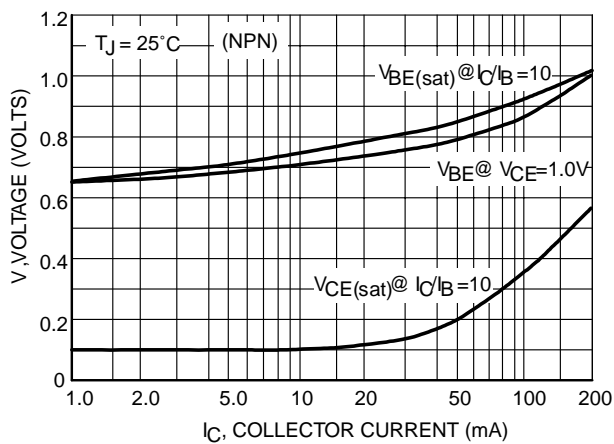

Figure 17. "ON" Voltages

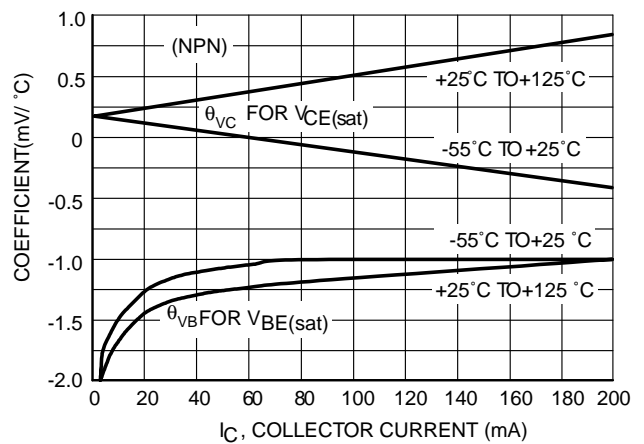

Figure 18. Temperature Coefficients

LMBT3946DW1T1G

TYPICAL ELECTRICAL CHARACTERISTICS
LMBT3946DW1T1G
(PNP)

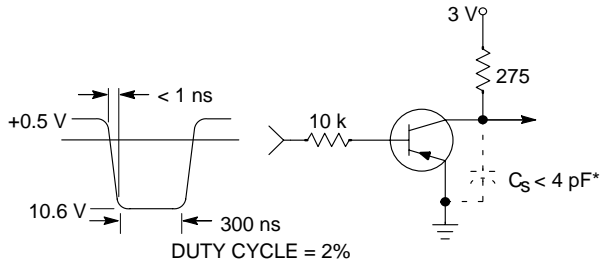

Figure 19. Delay and Rise Time Equivalent Test Circuit

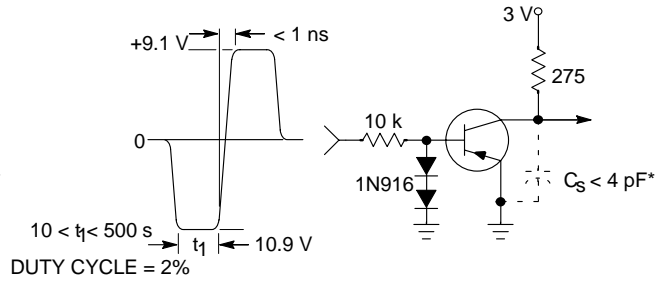

Figure 20. Storage and Fall Time Equivalent Test Circuit

* Total shunt capacitance of test jig and connectors

TYPICAL TRANSIENT CHARACTERISTICS

— $T_J = 25^\circ\text{C}$
 - - - $T_J = 125^\circ\text{C}$

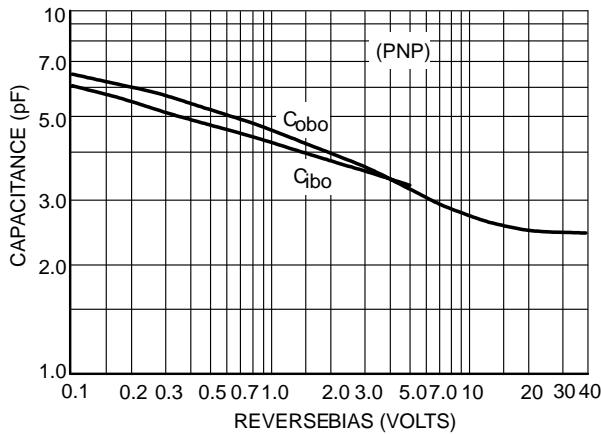

Figure 21. Capacitance

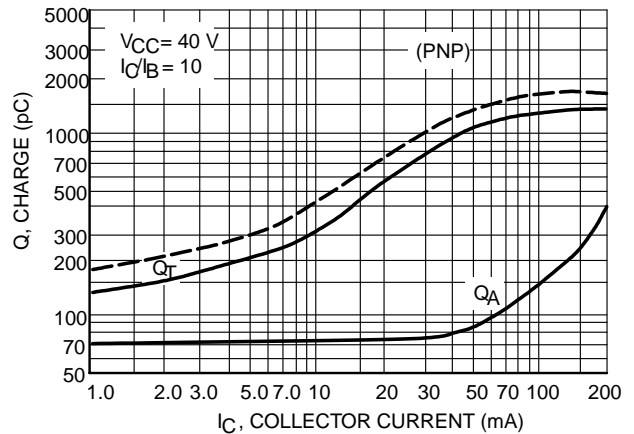

Figure 22. Charge Data

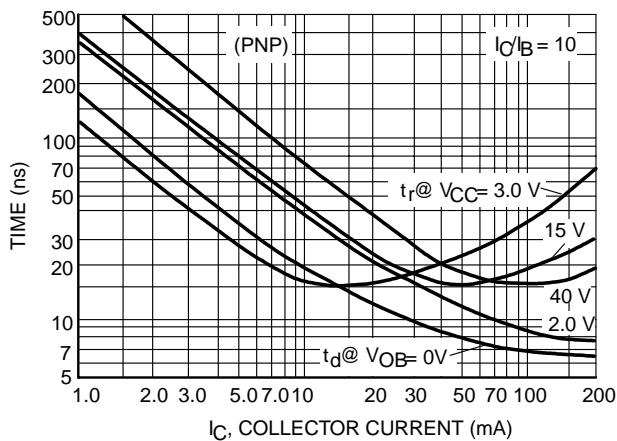

Figure 23. Turn-On Time

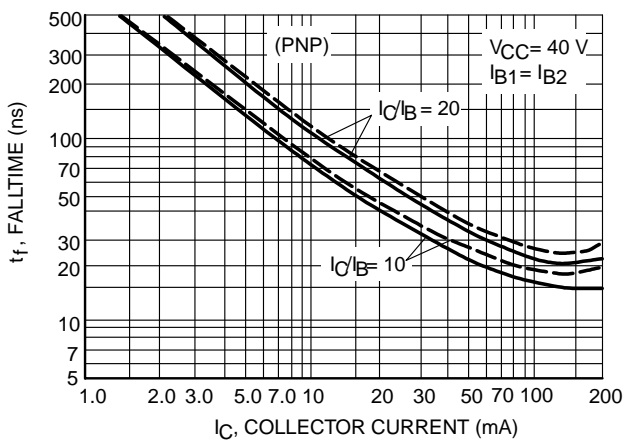

Figure 24. Fall Time

TYPICAL ELECTRICAL CHARACTERISTICS

LMBT3946DW1T1G

LMBT3946DW1T1G

(PNP)

TYPICAL AUDIO SMALL-SIGNAL CHARACTERISTICS
NOISE FIGURE VARIATIONS

($V_{CE} = \pm 5.0$ Vdc, $T_A = 25^\circ\text{C}$, Bandwidth = 1.0 Hz)

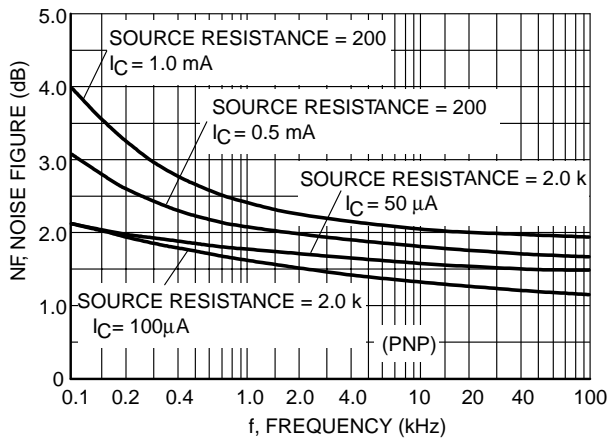

Figure 25.

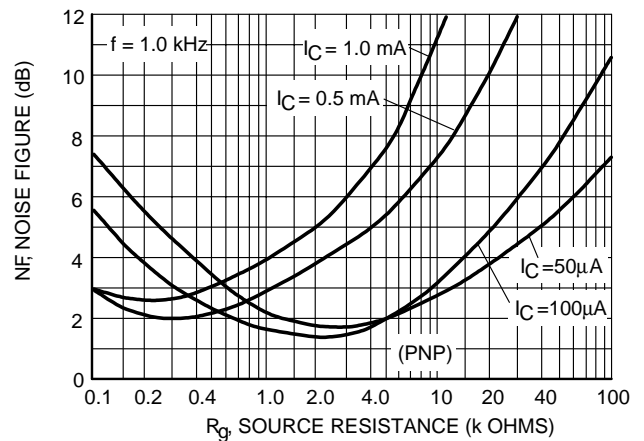

Figure 26.

h PARAMETERS

($V_{CE} = \pm 10$ Vdc, $f = 1.0$ kHz, $T_A = 25^\circ\text{C}$)

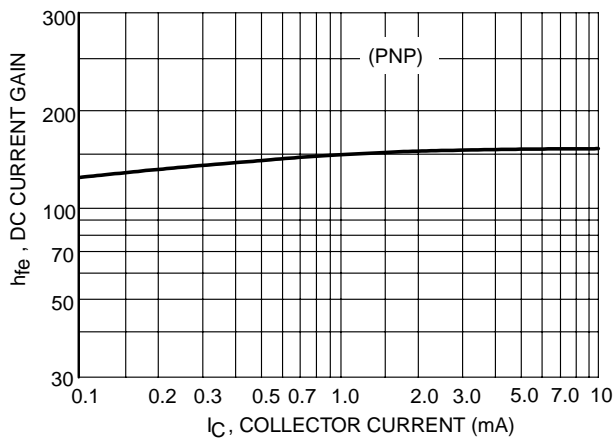

Figure 27. Current Gain

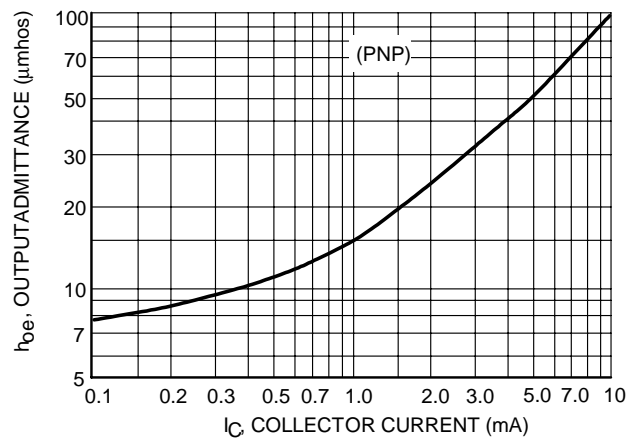

Figure 28. Output Admittance

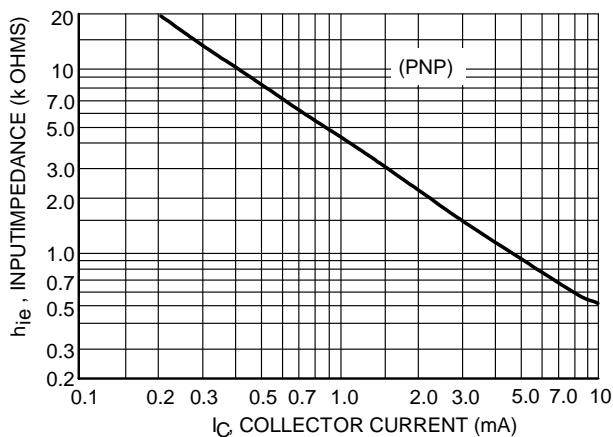

Figure 29. Input Impedance

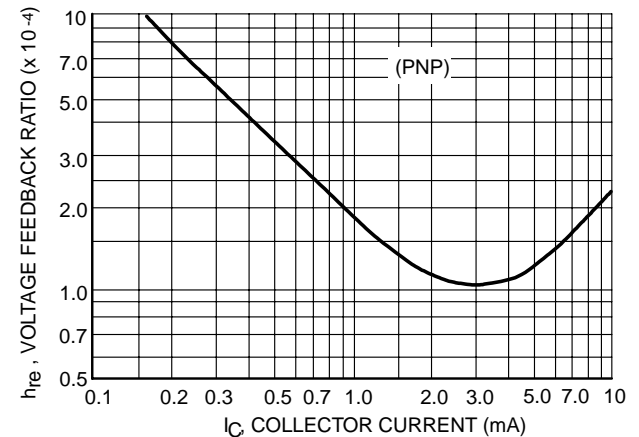

Figure 30. Voltage Feedback Ratio

LMBT3946DW1T1G

TYPICAL ELECTRICAL CHARACTERISTICS
LMBT3946DW1T1G
(PNP)

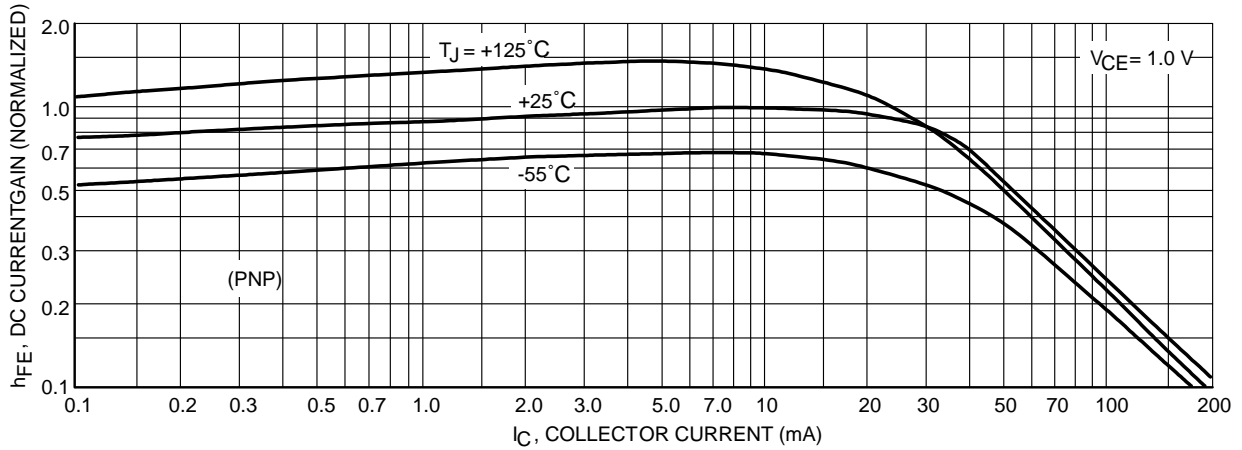

Figure 31. DC Current Gain

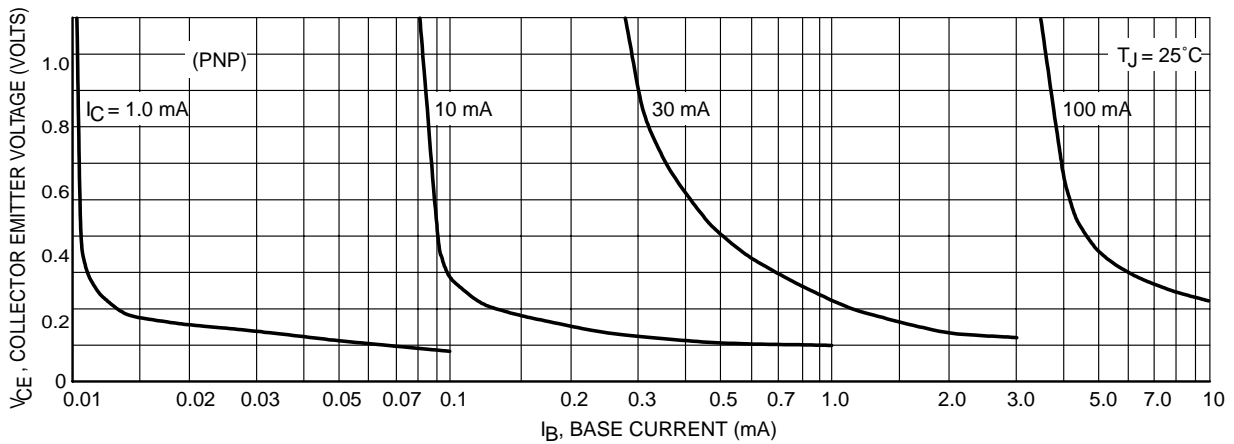

Figure 32. Collector Saturation Region

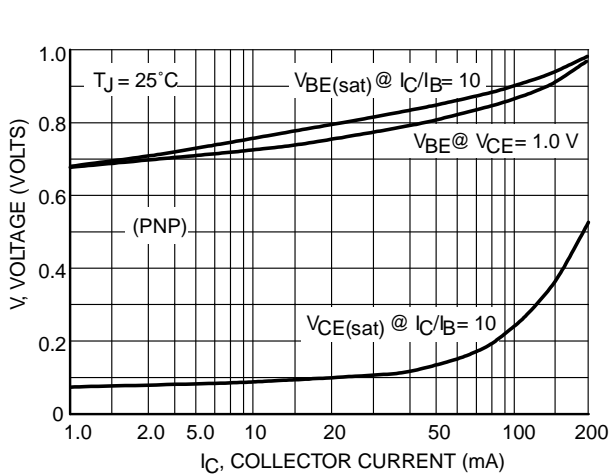

Figure 33. "ON" Voltages

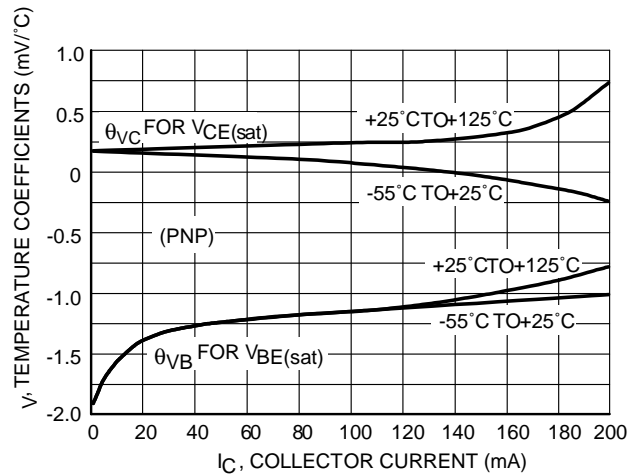
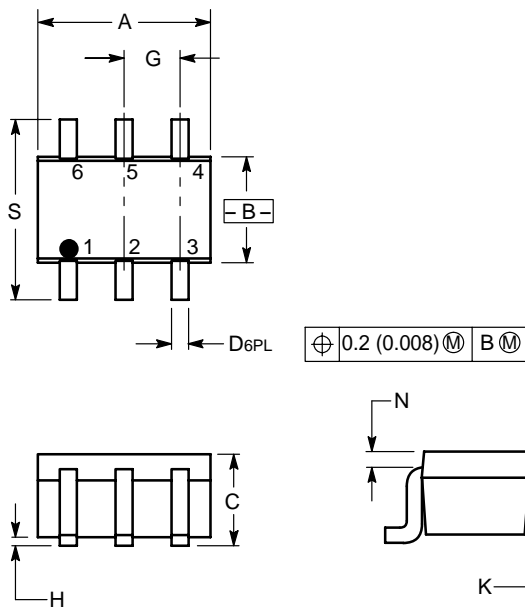

Figure 34. Temperature Coefficients

LMBT3946DW1T1G

SC-88/SOT-363



NOTES:

1. DIMENSIONING AND TOLERANCING PER ANSI Y14.5M, 1982.
2. CONTROLLING DIMENSION: INCH.

DIM	INCHES		MILLIMETERS	
	MIN	MAX	MIN	MAX
A	0.071	0.087	1.80	2.20
B	0.045	0.053	1.15	1.35
C	0.031	0.043	0.80	1.10
D	0.004	0.012	0.10	0.30
G	0.026 BSC		0.65 BSC	
H	---	0.004	---	0.10
J	0.004	0.010	0.10	0.25
K	0.004	0.012	0.10	0.30
N	0.008 REF		0.20 REF	
S	0.079	0.087	2.00	2.20

- PIN 1. EMITTER 2
 2. BASE 2
 3. COLLECTOR 1
 4. EMITTER 1
 5. BASE 1
 6. COLLECTOR 2

