

2.5V Drive Pch+SBD MOSFET

ES6U42

●Structure

Silicon P-channel MOSFET /
Schottky barrier diode

●Features

- 1) Pch MOSFET and schottky barrier diode are put in WEMT6 package.
- 2) High-speed switching, Low On-resistance.
- 3) Low voltage drive (2.5V drive).
- 4) Built-in Low V_f schottky barrier diode.

●Applications

Switching

●Package specifications

Type	Package	Taping
	Code	T2R
	Basic ordering unit (pieces)	8000
ES6U42		○

●Dimensions (Unit : mm)

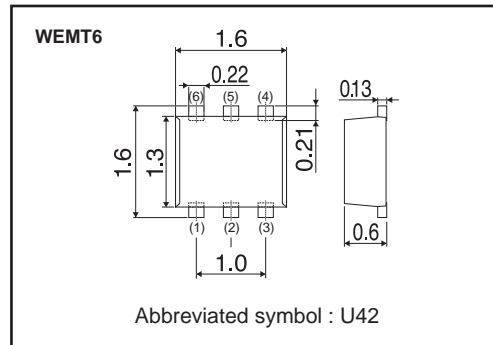

●Inner circuit

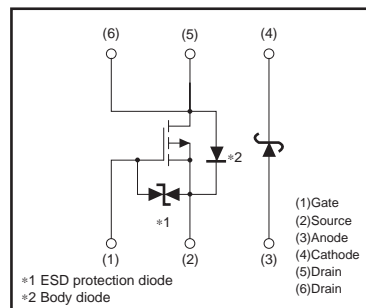

●Absolute maximum ratings (Ta=25°C)

<MOSFET>

Parameter	Symbol	Limits	Unit	
Drain-source voltage	V_{DS}	-20	V	
Gate-source voltage	V_{GS}	± 12	V	
Drain current	Continuous	I_D	± 1.0	A
	Pulsed	I_{DP} *1	± 4.0	A
Source current (Body diode)	Continuous	I_S	-0.4	A
	Pulsed	I_{SP} *1	-4.0	A
Channel temperature	T_{ch}	150	°C	
Power dissipation	P_D *2	0.7	W / ELEMENT	

*1 $P_W \leq 10 \mu s$, Duty cycles $\leq 1\%$
*2 Mounted on a ceramic board

<Di>

Parameter	Symbol	Limits	Unit
Repetitive peak reverse voltage	V_{RM}	25	V
Reverse voltage	V_R	20	V
Forward current	I_F	0.5	A
Forward current surge peak	I_{FSM} *1	2.0	A
Junction temperature	T_j	150	°C
Power dissipation	P_D *2	0.5	W / ELEMENT

*1 60Hz · 1cycle
*2 Mounted on a ceramic board

<MOSFET and Di>

Parameter	Symbol	Limits	Unit
Power dissipation	P_D *	0.8	W / TOTAL
Range of storage temperature	T_{stg}	-55 to +150	°C

* Mounted on a ceramic board

●Electrical characteristics (Ta=25°C)

<MOSFET>

Parameter	Symbol	Min.	Typ.	Max.	Unit	Conditions
Gate-source leakage	I _{GSS}	–	–	±10	μA	V _{GS} = ±12V, V _{DS} =0V
Drain-source breakdown voltage	V _{(BR) DSS}	–20	–	–	V	I _D = –1mA, V _{GS} =0V
Zero gate voltage drain current	I _{DSS}	–	–	–1	μA	V _{DS} = –20V, V _{GS} =0V
Gate threshold voltage	V _{GS(th)}	–0.7	–	–2.0	V	V _{DS} = –10V, I _D = –1mA
Static drain-source on-state resistance	R _{DS(on)} *	–	280	390	mΩ	I _D = –1A, V _{GS} = –4.5V
		–	310	430	mΩ	I _D = –1A, V _{GS} = –4V
		–	570	800	mΩ	I _D = –0.5A, V _{GS} = –2.5V
Forward transfer admittance	Y _{fs} *	0.7	–	–	S	V _{DS} = –10V, I _D = –0.5A
Input capacitance	C _{iss}	–	150	–	pF	V _{DS} = –10V
Output capacitance	C _{oss}	–	20	–	pF	V _{GS} = 0V
Reverse transfer capacitance	C _{rss}	–	20	–	pF	f= 1MHz
Turn-on delay time	t _{d(on)} *	–	9	–	ns	V _{DD} ≐ –15V
Rise time	t _r *	–	8	–	ns	V _{GS} = –4.5V
Turn-off delay time	t _{d(off)} *	–	25	–	ns	I _D = –0.5A
Fall time	t _f *	–	10	–	ns	R _L ≐ 30Ω
Total gate charge	Q _g *	–	2.1	–	nC	V _{DD} ≐ –15V, V _{GS} = –4.5V
Gate-source charge	Q _{gs} *	–	0.5	–	nC	I _D = –1A, R _L ≐ 15Ω
Gate-drain charge	Q _{gd} *	–	0.5	–	nC	R _G = 10Ω

*Pulsed

<Body diode characteristics (Source-drain)>

Parameter	Symbol	Min.	Typ.	Max.	Unit	Conditions
Forward voltage	V _{SD} *	–	–	–1.2	V	I _S = –1.0A, V _{GS} =0V

*Pulsed

<Di>

Parameter	Symbol	Min.	Typ.	Max.	Unit	Conditions
Forward voltage	V _F	–	–	0.36	V	I _F = 0.1A
		–	–	0.52	V	I _F = 0.5A
Reverse current	I _R	–	–	100	μA	V _R = 20V

●Electrical characteristics curves

<MOSFET>

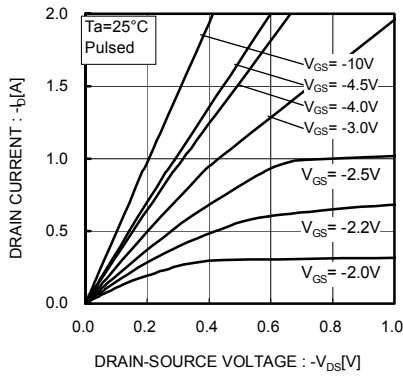

Fig.1 Typical Output Characteristics (I)

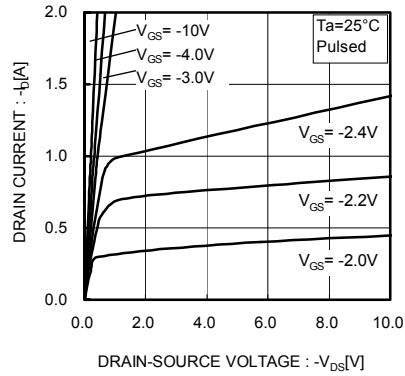

Fig.2 Typical Output Characteristics (II)

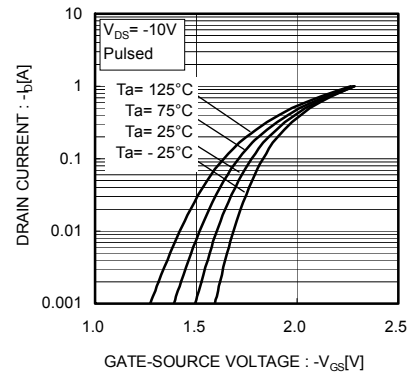

Fig.3 Typical Transfer Characteristics

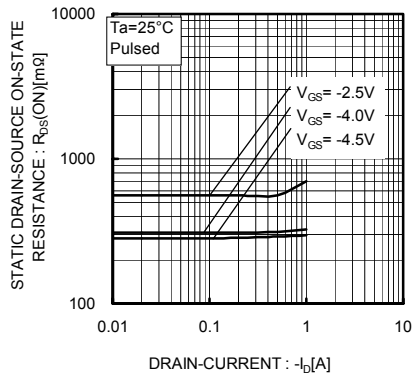

Fig.4 Static Drain-Source On-State Resistance vs. Drain Current (I)

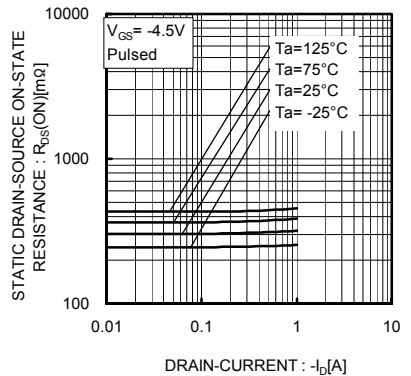

Fig.5 Static Drain-Source On-State Resistance vs. Drain Current (II)

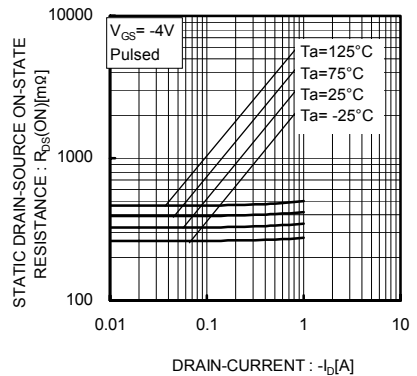

Fig.6 Static Drain-Source On-State Resistance vs. Drain Current (III)

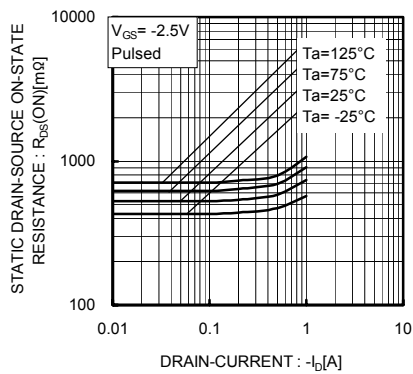

Fig.7 Static Drain-Source On-State Resistance vs. Drain Current (IV)

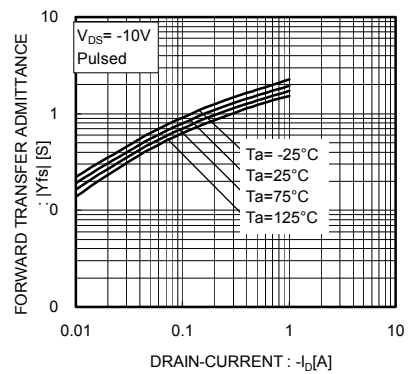

Fig.8 Forward Transfer Admittance vs. Drain Current

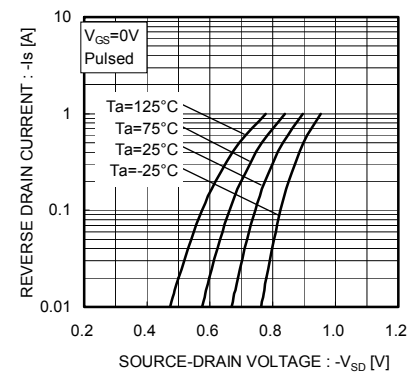

Fig.9 Reverse Drain Current vs. Source-Drain Voltage

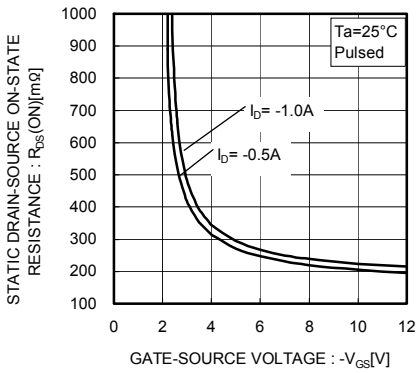

Fig.10 Static Drain-Source On-State Resistance vs. Gate Source Voltage

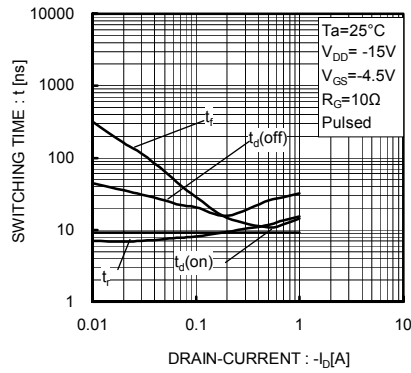

Fig.11 Switching Characteristics

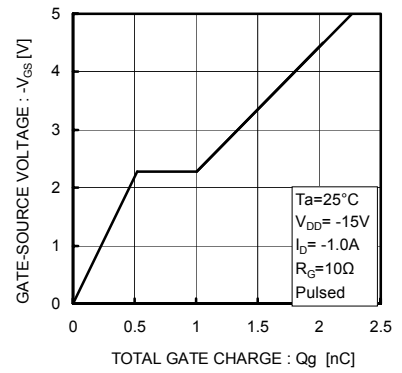

Fig.12 Dynamic Input Characteristics

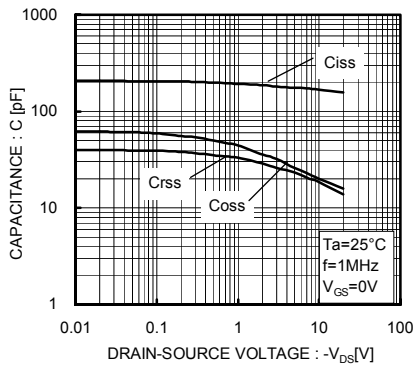

Fig.13 Typical Capacitance vs. Drain-Source Voltage

<Di>

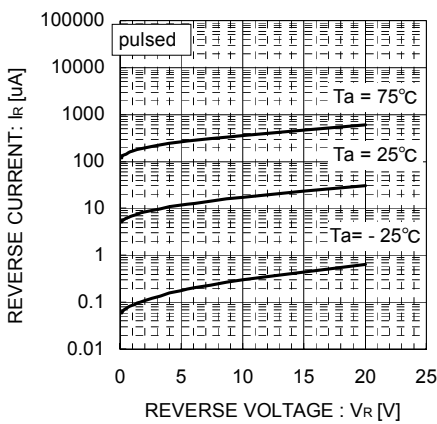

Fig.1 Reverse Current vs. Reverse Voltage

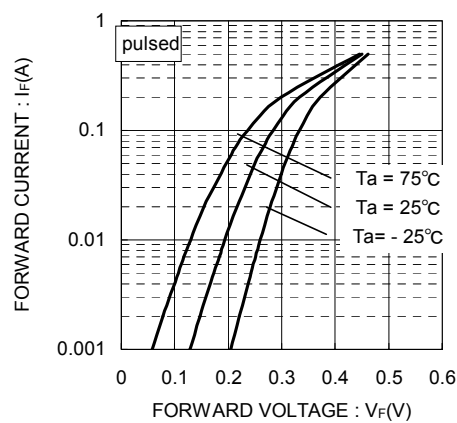

Fig.2 Forward Current vs. Forward Voltage

●Measurement circuit

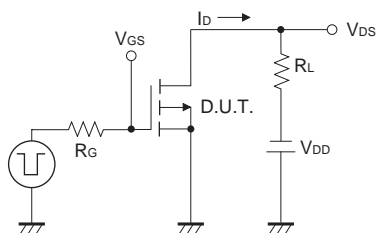

Fig.1-1 Switching Time Measurement Circuit

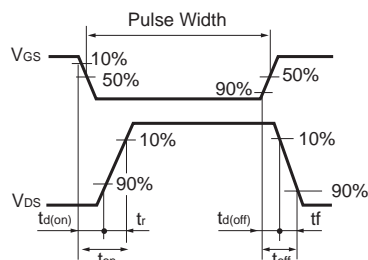

Fig.1-2 Switching Waveforms

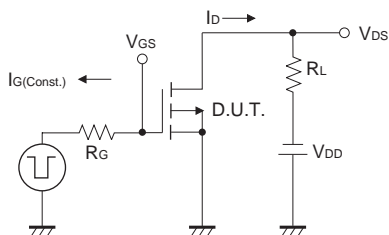

Fig.2-1 Gate Charge Measurement Circuit

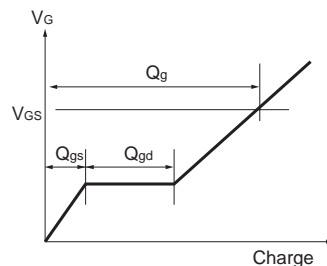

Fig.2-2 Gate Charge Waveform

●Notice

1. SBD has a large reverse leak current compared to other type of diode. Therefore; it would raise a junction temperature, and increase a reverse power loss. Further rise of inside temperature would cause a thermal runaway.
This built-in SBD has low V_F characteristics and therefore, higher leak current. Please consider enough the surrounding temperature, generating heat of MOSFET and the reverse current.
2. This product might cause chip aging and breakdown under the large electrified environment. Please consider to design ESD protection circuit.

Notes

No copying or reproduction of this document, in part or in whole, is permitted without the consent of ROHM CO.,LTD.

The content specified herein is subject to change for improvement without notice.

The content specified herein is for the purpose of introducing ROHM's products (hereinafter "Products"). If you wish to use any such Product, please be sure to refer to the specifications, which can be obtained from ROHM upon request.

Examples of application circuits, circuit constants and any other information contained herein illustrate the standard usage and operations of the Products. The peripheral conditions must be taken into account when designing circuits for mass production.

Great care was taken in ensuring the accuracy of the information specified in this document. However, should you incur any damage arising from any inaccuracy or misprint of such information, ROHM shall bear no responsibility for such damage.

The technical information specified herein is intended only to show the typical functions of and examples of application circuits for the Products. ROHM does not grant you, explicitly or implicitly, any license to use or exercise intellectual property or other rights held by ROHM and other parties. ROHM shall bear no responsibility whatsoever for any dispute arising from the use of such technical information.

The Products specified in this document are intended to be used with general-use electronic equipment or devices (such as audio visual equipment, office-automation equipment, communication devices, electronic appliances and amusement devices).

The Products are not designed to be radiation tolerant.

While ROHM always makes efforts to enhance the quality and reliability of its Products, a Product may fail or malfunction for a variety of reasons.

Please be sure to implement in your equipment using the Products safety measures to guard against the possibility of physical injury, fire or any other damage caused in the event of the failure of any Product, such as derating, redundancy, fire control and fail-safe designs. ROHM shall bear no responsibility whatsoever for your use of any Product outside of the prescribed scope or not in accordance with the instruction manual.

The Products are not designed or manufactured to be used with any equipment, device or system which requires an extremely high level of reliability the failure or malfunction of which may result in a direct threat to human life or create a risk of human injury (such as a medical instrument, transportation equipment, aerospace machinery, nuclear-reactor controller, fuel-controller or other safety device). ROHM shall bear no responsibility in any way for use of any of the Products for the above special purposes. If a Product is intended to be used for any such special purpose, please contact a ROHM sales representative before purchasing.

If you intend to export or ship overseas any Product or technology specified herein that may be controlled under the Foreign Exchange and the Foreign Trade Law, you will be required to obtain a license or permit under the Law.

Thank you for your accessing to ROHM product informations.

More detail product informations and catalogs are available, please contact your nearest sales office.

ROHM Customer Support System

THE AMERICAS / EUROPE / ASIA / JAPAN

www.rohm.com

Contact us : webmaster@rohm.co.jp