

SAI Series

Switching Type — Surface-mount and Separate Excitation Type

Features

- Surface-mount package with high output and efficiency
- Requires only 4 external components
- Phase correction and output voltage adjustment performed internally
- Built-in reference oscillator (60 kHz)
- Built-in overcurrent and thermal protection circuits

Applications

- For power supplies in telephone sets
- For power supplies in office equipment

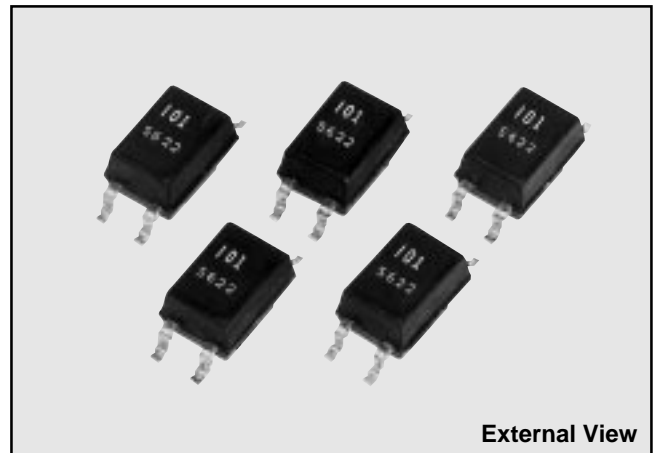

Lineup

Type No.	V_o (V)	I_o (A)
SAI01	5	0.5
SAI02	3.3	
SAI03	12	0.4
SAI04	15	
SAI05	13	
SAI06	9	

Absolute Maximum Ratings

Parameter	Symbol	Ratings	Unit
DC Input Voltage	V_{IN}	35	V
Power Dissipation	P_D	0.75	W
Junction Temperature	T_j	+125	°C
Storage Temperature	T_{stg}	-40 to +125	°C
SW Terminal Applied Reverse Voltage	V_{sw}	-1	V
Thermal Resistance* (junction-to-case)	$R_{th(j-c)}$	20	°C/W

* Refer to Outline Drawing for the case temperature measuring points.

Recommended Operating Conditions

Parameter	Symbol	Ratings						Unit
		SAI01	SAI02	SAI03	SAI04	SAI05	SAI06	
DC Input Voltage Range	V_{IN}	7 to 33	5.3 to 33	15 to 33	18 to 33	16 to 33	12 to 33	V
Output Current Range	I_o	0 to 0.5		0 to 0.4				A
Operating Junction Temperature Range	T_{jop}	-30 to +125						°C

Electrical Characteristics

Parameter	Symbol	Ratings																		Unit
		SAI01			SAI02			SAI03			SAI04			SAI05			SAI06			
		min	typ	max	min	typ	max	min	typ	max	min	typ	max	min	typ	max	min	typ	max	
Output Voltage	V_o	4.80	5.00	5.20	3.17	3.30	3.43	11.40	12.00	12.60	14.25	15.00	15.75	12.35	13.00	13.65	8.55	9.00	9.45	V
	Condition	$V_{IN}=20V, I_o=0.3A$			$V_{IN}=15V, I_o=0.3A$			$V_{IN}=24V, I_o=0.3A$			$V_{IN}=27V, I_o=0.3A$			$V_{IN}=25V, I_o=0.3A$			$V_{IN}=21V, I_o=0.3A$			
Efficiency	η	80			75			88			89			88			86			%
	Condition	$V_{IN}=20V, I_o=0.3A$			$V_{IN}=15V, I_o=0.3A$			$V_{IN}=24V, I_o=0.3A$			$V_{IN}=27V, I_o=0.3A$			$V_{IN}=25V, I_o=0.3A$			$V_{IN}=21V, I_o=0.3A$			
Switching Frequency	f	60			60			60			60			60			60			kHz
	Condition	$V_{IN}=20V, I_o=0.3A$			$V_{IN}=15V, I_o=0.3A$			$V_{IN}=24V, I_o=0.3A$			$V_{IN}=27V, I_o=0.3A$			$V_{IN}=25V, I_o=0.3A$			$V_{IN}=21V, I_o=0.3A$			
Line Regulation	ΔV_{OLINE}	80 100			60 80			100 130			100 130			100 130			90 110			mV
	Condition	$V_{IN}=10 \text{ to } 30V, I_o=0.3A$			$V_{IN}=8 \text{ to } 30V, I_o=0.3A$			$V_{IN}=18 \text{ to } 30V, I_o=0.3A$			$V_{IN}=21 \text{ to } 30V, I_o=0.3A$			$V_{IN}=19 \text{ to } 30V, I_o=0.3A$			$V_{IN}=15 \text{ to } 30V, I_o=0.3A$			
Load Regulation	ΔV_{OLOAD}	30 40			20 30			70 95			90 120			75 100			50 80			mV
	Condition	$V_{IN}=20V, I_o=0.1 \text{ to } 0.4A$			$V_{IN}=15V, I_o=0.1 \text{ to } 0.4A$			$V_{IN}=24V, I_o=0.1 \text{ to } 0.4A$			$V_{IN}=27V, I_o=0.1 \text{ to } 0.4A$			$V_{IN}=25V, I_o=0.1 \text{ to } 0.4A$			$V_{IN}=21V, I_o=0.1 \text{ to } 0.4A$			
Temperature Coefficient of Output Voltage	$\Delta V_o/\Delta T$	± 0.5			± 0.5			± 1.5			± 1.5			± 1.5			± 1.0			mV/°C
Ripple Rejection	RREJ	45			45			45			45			45			45			dB
	Condition	f=100 to 120Hz																		
Overcurrent Protection Starting Current	I_s	0.55			0.55			0.45			0.45			0.45			0.45			A
	Condition	$V_{IN}=10V$			$V_{IN}=8V$			$V_{IN}=18V$			$V_{IN}=21V$			$V_{IN}=19V$			$V_{IN}=15V$			

Outline Drawing (unit:mm)

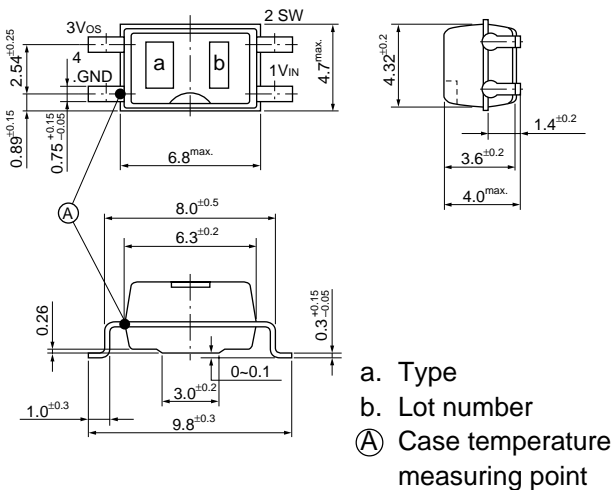

Plastic Mold Package Type
Flammability: UL94V-0

Weight: Approx. 0.22 g

Terminal Connections

- (1) Input
- (2) Switching output
- (3) Output Voltage Detection
- (4) Ground

Block Diagram

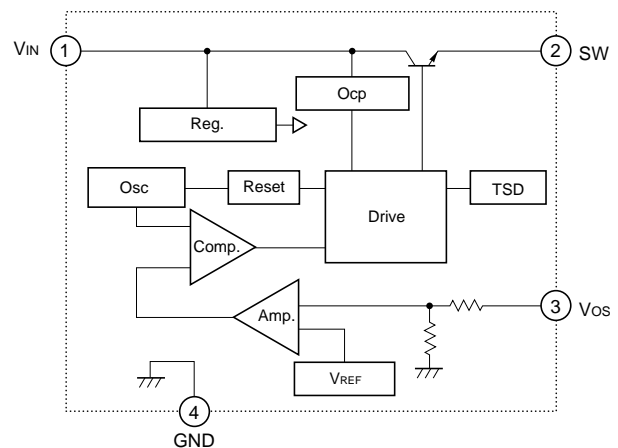

Standard External Circuit

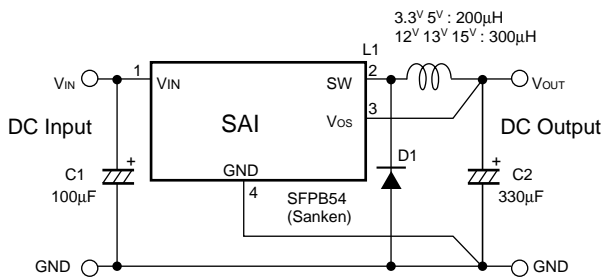

Example of Printed-circuit board

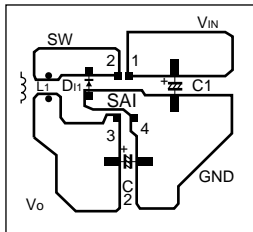

- For optimum operation, there must be only one GND line originating from terminal 4 and each component must be connected with the shortest possible wiring.
- To prevent heating of the IC, it is best to make the GND pattern larger since the internal frame and terminal 4 (GND) are connected to each other.

Ta-PD Characteristics

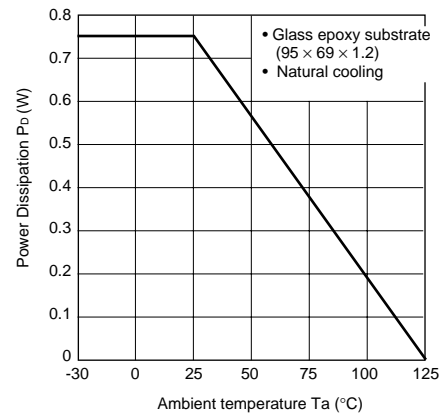

$$P_D = V_O \cdot I_O \left(\frac{100}{\eta_X} - 1 \right) - V_F \cdot I_O \left(1 - \frac{V_O}{V_{IN}} \right)$$

The efficiency depends on the input voltage and the output current. Thus, obtain the value from the efficiency graph on page 8 and substitute the percentage in the formula above.

$$\left\{ \begin{array}{l} V_O : \text{Output voltage} \\ I_O : \text{Output current} \\ \eta_X : \text{Efficiency (\%)} \\ V_F : \text{Diode forward voltage} \\ \text{SFPB54-0.3V} \end{array} \right.$$

Thermal design for D₁ must be performed separately.

Selecting external components

1. Inductor L1

- It must be suited for switching regulators.
Do not use inductors for noise filters as they generate excessive heat.
- It must have the appropriate inductance value.
If the inductance is too small (150µH or lower), abnormal oscillation may occur causing operation problems in the overcurrent protection circuit within the rated current range.
- The rated current must be satisfied.
If the rated current is exceeded, magnetic saturation leads to overcurrent.

2. Capacitors C1 and C2

- They must satisfy the breakdown voltage and allowable ripple current.
Use of these capacitors over their derating values shortens their service lives and may also cause abnormal oscillation of the IC.
- C₂ must be a low-impedance type capacitor.
A low-impedance type capacitor is recommended for C₂ to ensure minimum ripple voltage and stable switching operation.

3. Diode D1

The Sanken SFPB54 diode is recommended for D₁. If you intend to use an equivalent diode, be sure to make use of a Schottky barrier diode and make sure that the reverse voltage applied to terminal 2 of the IC does not exceed the value (-1V) given in the absolute maximum ratings. If you use a fast recovery diode or any other diode, application of a reverse voltage generated from the recovery or ON voltage of the diode may damage the IC.

SAI Series Typical Characteristics

Rise Characteristics (SAI01)

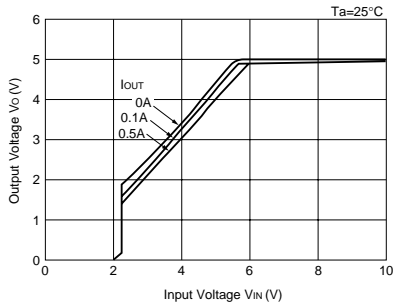

Efficiency Characteristics (SAI01)

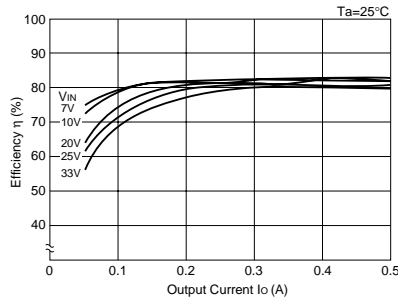

Load Regulation (SAI01)

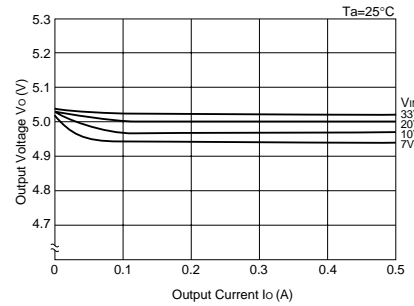

Temperature Characteristics (SAI01)

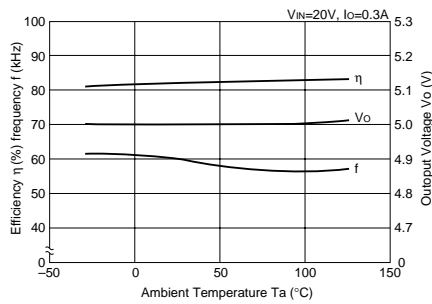

Overcurrent Protection Characteristics (SAI01)

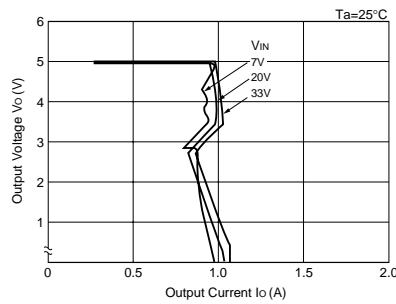

Thermal Protection Characteristics (SAI01)

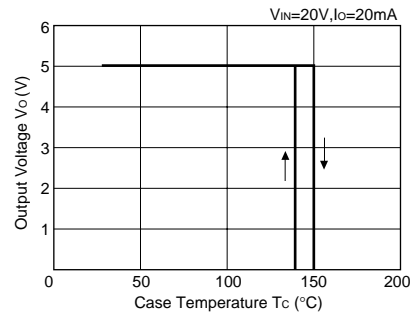

Rise Characteristics (SAI03)

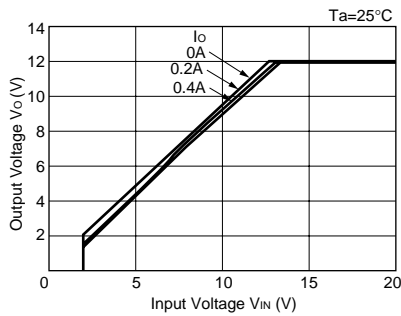

Efficiency Characteristics (SAI03)

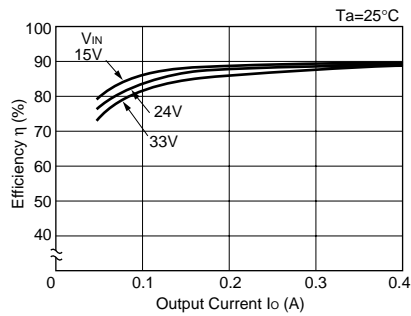

Load Regulation (SAI03)

