

# LMV761/LMV762

## Low Voltage, Precision Comparator with Push-Pull Output

### General Description

The LMV761/762 are precision comparators intended for applications requiring low noise and low input offset voltage. The LMV761 single has a shutdown pin that can be used to disable the device and reduce the supply current. The LMV761 is available in a space saving SOT23-6 or SOIC-8 package. The LMV762 dual is available in SOIC-8 or MSOP-8 package.

They feature a CMOS input and Push-Pull output stage. The Push-Pull output stage eliminates the need for an external pull-up resistor.

The LMV761/762 are designed to meet the demands of small size, low power and high performance required by portable and battery operated electronics.

The input offset voltage has a typical value of 200 $\mu$ V at room temp and a 1mV limit over temp.

### Features

( $V_S = 5V, T_A = 25^\circ C$ , Typical values unless specified)

- Input offset voltage 0.2mV
- Input offset voltage (max over temp) 1mV
- Input bias current 0.2pA
- Propagation delay (OD = 50mV) 120 nsec
- Low supply current 300 $\mu$ A
- CMRR 100dB
- PSRR 110dB
- Extended Temperature Range  $-40^\circ C$  to  $125^\circ C$
- Push-pull output
- Ideal for 2.7V and 5V single supply applications
- Available in space-saving packages:
  - 6-Pin SOT23 (single w/shutdown)
  - 8-Pin SOIC (single w/shutdown)
  - 8-Pin SOIC/MSOP (dual without shutdown)

### Applications

- Portable and battery-powered systems
- Scanners
- Set top boxes
- High speed differential line receiver
- Window comparators
- Zero-crossing detectors
- High speed sampling circuits

### Typical Circuit

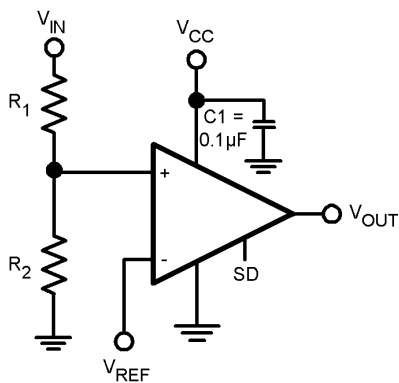

Threshold Detector

20037032

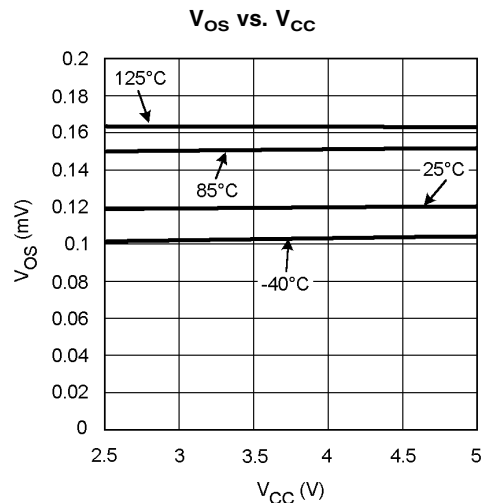

20037010

**Absolute Maximum Ratings** (Note 1)

If Military/Aerospace specified devices are required, please contact the National Semiconductor Sales Office/Distributors for availability and specifications.

ESD Tolerance (Note 2)	
Human Body Model	2000V
Machine Model	200V
Supply Voltage ( $V^+ - V^-$ )	5.5V
Differential Input Voltage	Supply Voltage
Voltage between any two pins	Supply Voltage
Output Short Circuit to $V^+ - V^-$	
Soldering Information	
Infrared or Convection (20 sec.)	235°C

Wave Soldering (10 sec.)	260°C (Lead Temp)
Junction Temperature	150°C
Storage Temperature Range	-65°C to 150°C

**Operating Ratings**

Supply Voltage ( $V^+ - V^-$ )	2.7V to 5.0V
Temperature Range	-40°C to +125°C
Package Thermal Resistance (Note 4)	
SOT23-6	265°C/W
SOIC-8	190°C/W
MSOP-8	235°C/W

**2.7V Electrical Characteristics**

Unless otherwise specified, all limited guaranteed for  $T_J = 25^\circ\text{C}$ ,  $V_{CM} = V^+/2$ ,  $V^+ = 2.7\text{V}$ ,  $V^- = 0\text{V}^-$ . **Boldface** limits apply at the temperature extremes. (Note 5)

Symbol	Parameter	Condition	Min (Note 7)	Typ (Note 6)	Max (Note 7)	Units
$V_{OS}$	Input Offset Voltage			0.2	<b>1.0</b>	mV
$I_B$	Input Bias Current (Note 8)			0.2	50	pA
$I_{OS}$	Input Offset Current (Note 8)			.001	5	pA
CMRR	Common Mode Rejection Ratio	$0\text{V} < V_{CM} < V_{CC} - 1.3\text{V}$	80	100		dB
PSRR	Power Supply Rejection Ratio	$V^+ = 2.7\text{V}$ to 5V	80	110		dB
CMVR	Input Common Mode Voltage Range	CMRR > 50dB			-0.3 1.5	V
$V_O$	Output Swing High	$I_L = 2\text{mA}$ , $V_{ID} = 200\text{mV}$	$V^+ - 0.35$	$V^+ - 0.1$		V
	Output Swing Low	$I_L = -2\text{mA}$ , $V_{ID} = -200\text{mV}$		90	250	mV
$I_{SC}$	Output Short Circuit Current (Note 3)	Sourcing, $V_O = 1.35\text{V}$ , $V_{ID} = 200\text{mV}$	6.0	20		mA
		Sinking, $V_O = 1.35\text{V}$ , $V_{ID} = -200\text{mV}$	6.0	15		
$I_S$	Supply Current					$\mu\text{A}$
	LMV761 (Single Comparator)			275	700	
	LMV762 (Both Comparators)			550	1400	
$I_{OUT\ LEAKAGE}$	Output Leakage I @ Shutdown	$\overline{SD} = \text{GND}$ , $V_O = 2.7\text{V}$		0.20		$\mu\text{A}$
$I_{S\ LEAKAGE}$	Supply Leakage I @ Shutdown	$\overline{SD} = \text{GND}$ , $V_{CC} = 2.7\text{V}$		0.20	2	$\mu\text{A}$
$t_{PD}$	Propagation Delay $R_L = 5.1\text{k}\Omega$ $C_L = 50\text{pF}$	Overdrive = 5mV		270		ns
		Overdrive = 10mV		205		
		Overdrive = 50mV		120		
$t_{SKEW}$	Propagation Delay Skew			5		ns
$t_r$	Output Rise Time	10% to 90%		1.7		ns
$t_f$	Output Fall Time	90% to 10%		1.8		ns
$t_{on}$	Turn On Time From Shutdown			6		$\mu\text{s}$

**5.0V Electrical Characteristics**

Unless otherwise specified, all limited guaranteed for  $T_J = 25^\circ\text{C}$ ,  $V_{CM} = V^+/2$ ,  $V^+ = 5.0\text{V}$ ,  $V^- = 0\text{V}^-$ . **Boldface** limits apply at the temperature extremes.

Symbol	Parameter	Condition	Min (Note 7)	Typ (Note 6)	Max (Note 7)	Units
$V_{OS}$	Input Offset Voltage			0.2	<b>1.0</b>	mV
$I_B$	Input Bias Current (Note 8)			0.2	50	pA

## 5.0V Electrical Characteristics (Continued)

Unless otherwise specified, all limited guaranteed for  $T_J = 25^\circ\text{C}$ ,  $V_{CM} = V^+/2$ ,  $V^+ = 5.0\text{V}$ ,  $V^- = 0\text{V}$ . **Boldface** limits apply at the temperature extremes.

Symbol	Parameter	Condition	Min (Note 7)	Typ (Note 6)	Max (Note 7)	Units
$I_{OS}$	Input Offset Current (Note 8)			0.01	5	pA
CMRR	Common Mode Rejection Ratio	$0\text{V} < V_{CM} < V_{CC} - 1.3\text{V}$	80	100		dB
PSRR	Power Supply Rejection Ratio	$V^+ = 2.7\text{V}$ to $5\text{V}$	80	110		dB
CMVR	Input Common Mode Voltage Range	CMRR > 50dB			-.3 3.8	V
$V_O$	Output Swing High	$I_L = 4\text{mA}$ , $V_{ID} = 200\text{mV}$	$V^+ - 0.35$	$V^+ - 0.1$		V
	Output Swing Low	$I_L = -4\text{mA}$ , $V_{ID} = -200\text{mV}$		120	250	mV
$I_{SC}$	Output Short Circuit Current (Note 3)	Sourcing, $V_O = 2.5\text{V}$ , $V_{ID} = 200\text{mV}$	6.0	60		mA
		Sinking, $V_O = 2.5\text{V}$ , $V_{ID} = -200\text{mV}$	6.0	40		
$I_S$	Supply Current					$\mu\text{A}$
	LMV761 (Single Comparator)			225	700	
	LMV762 (Both Comparators)			450	1400	
$I_{OUT}$ LEAKAGE	Output Leakage I @ Shutdown	$\overline{SD} = \text{GND}$ , $V_O = 5.0\text{V}$		0.20		$\mu\text{A}$
$I_S$ LEAKAGE	Supply Leakage I @ Shutdown	$\overline{SD} = \text{GND}$ , $V_{CC} = 5.0\text{V}$		0.20	2	$\mu\text{A}$
$t_{PD}$	Propagation Delay $R_L = 5.1\text{k}\Omega$ $C_L = 50\text{pF}$	Overdrive = 5mV		225		ns
		Overdrive = 10mV		190		
		Overdrive = 50mV		120		
$t_{SKEW}$	Propagation Delay Skew			5		ns
$t_r$	Output Rise Time	10% to 90%		1.7		ns
$t_f$	Output Fall Time	90% to 10%		1.5		ns
$t_{on}$	Turn On Time from Shutdown			4		$\mu\text{s}$

**Note 1:** Absolute Maximum Ratings indicate limits beyond which damage to the device may occur. Operating Ratings indicate conditions for which the device is intended to be functional, but specific performance is not guaranteed. For guaranteed specifications and the test condition, see the Electrical Characteristics.

**Note 2:** Unless otherwise specified human body model is 1.5k $\Omega$  in series with 100pF. Machine model 200pF.

**Note 3:** Electrical Table values apply only for factory testing conditions at the temperature indicated. Factory testing conditions result in very limited self-heating of the device such that  $T_J = T_A$ . No guarantee of parametric performance is indicated in the electrical tables under conditions of internal self-heating where  $T_J > T_A$ . See Application section for information on temperature de-rating of this device. Absolute Maximum Rating indicate junction temperature limits beyond which the device may be permanently degraded, either mechanically or electrically.

**Note 4:** The maximum power dissipation is a function of  $T_{J(MAX)}$ ,  $\theta_{JA}$ , and  $T_A$ . The maximum allowable power dissipation at any ambient temperature is  $P_D = (T_{J(MAX)} - T_A) \theta_{JA}$ . All numbers apply for packages soldered directly into a PC board.

**Note 5:** Maximum temperature guarantee range is  $-40^\circ\text{C}$  to  $125^\circ\text{C}$ .

**Note 6:** Typical values represent the most likely parametric norm.

**Note 7:** All limits are guaranteed by testing or statistical analysis.

**Note 8:** Guaranteed by design

## Connection Diagrams

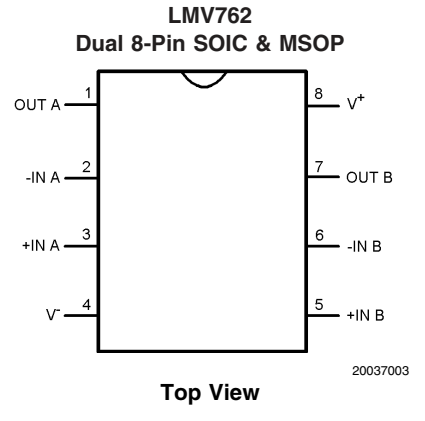
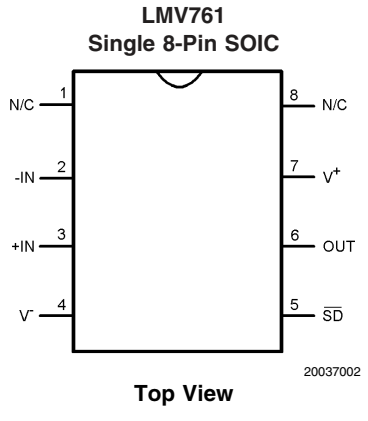
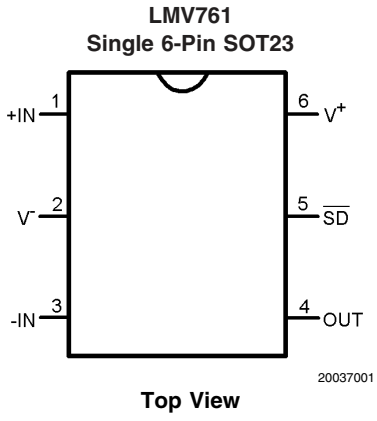

## Ordering Information

Package	Part Number	Package Marking	Transport Media	NSC Drawing
6-Pin SOT23	LMV761MF	C22A	1k units Tape and Reel	MF06A
	LMV761MFX		3k units Tape and Reel	
8-Pin SOIC	LMV761MA	LMV761MA	Rail	M08A
	LMV761MAX		2.5k Units Tape and Reel	
8-Pin SOIC	LMV762MA	LMV762MA	Rail	M08A
	LMV762MAX		2.5k Units Tape and Reel	
8-Pin MSOP	LMV762MM	C23A	1k Units Tape and Reel	MUA08A
	LMV762MMX		3.5k Units Tape and Reel	

# Typical Performance Characteristics

PSI vs.  $V_{CC}$  ( $V_O = \text{High}$ )

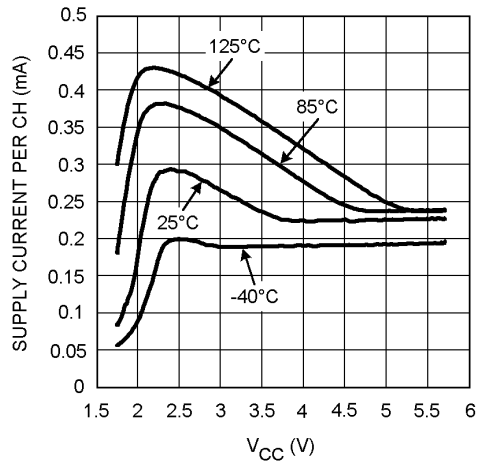

20037004

PSI vs.  $V_{CC}$  ( $V_O = \text{Low}$ )

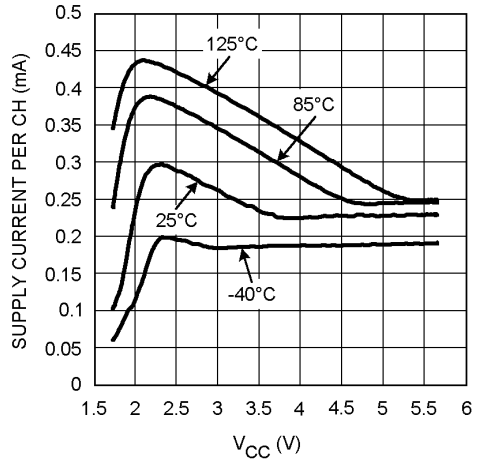

20037005

$V_{OS}$  vs.  $V_{CC}$

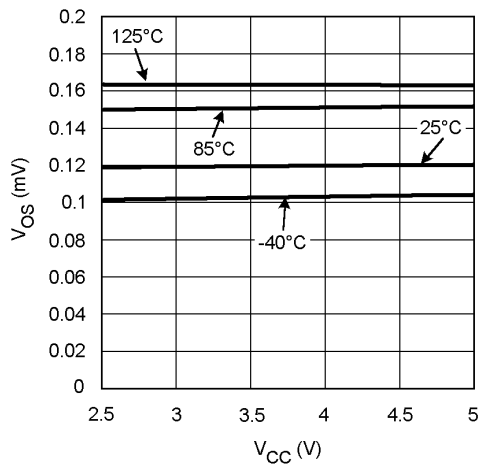

20037010

Input Bias vs. Common Mode @ 25°C

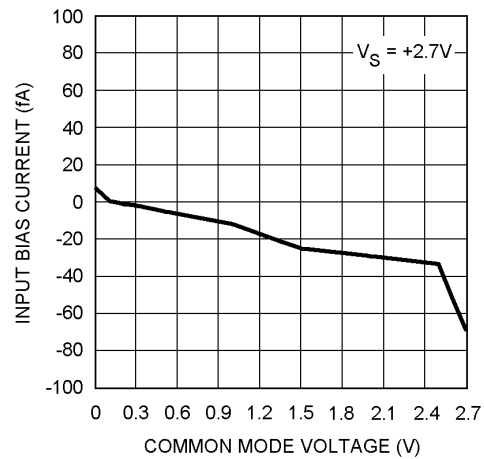

20037024

Input Bias vs. Common Mode @ 25°C

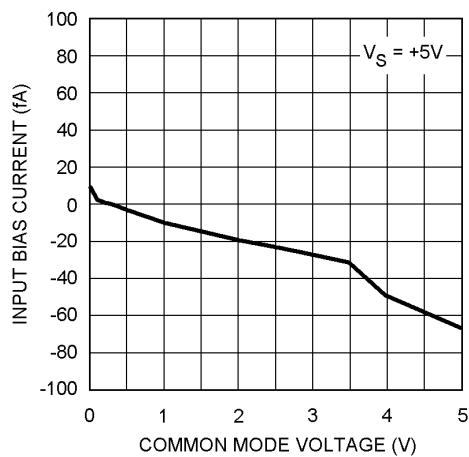

20037025

Output Voltage vs. Supply Voltage

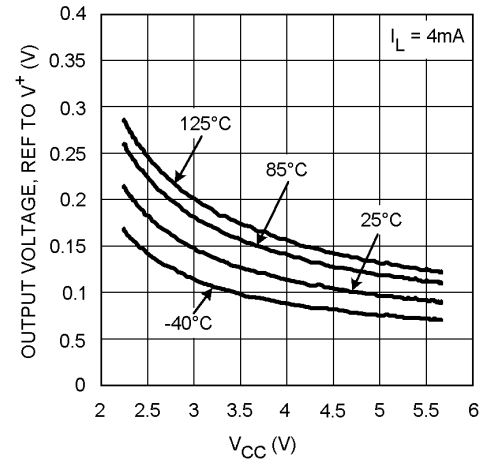

20037011

Typical Performance Characteristics (Continued)

Output Voltage vs. Supply Voltage

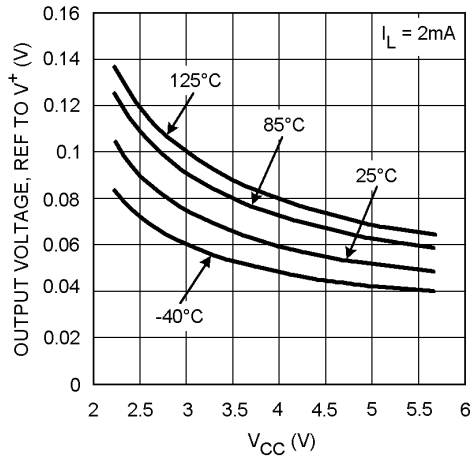

20037012

Output Voltage vs. Supply Voltage

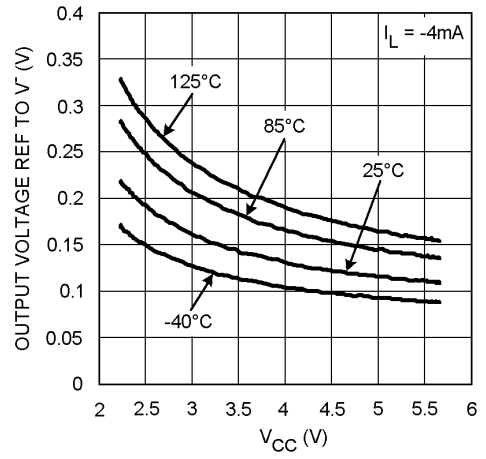

20037013

Output Voltage vs. Supply Voltage

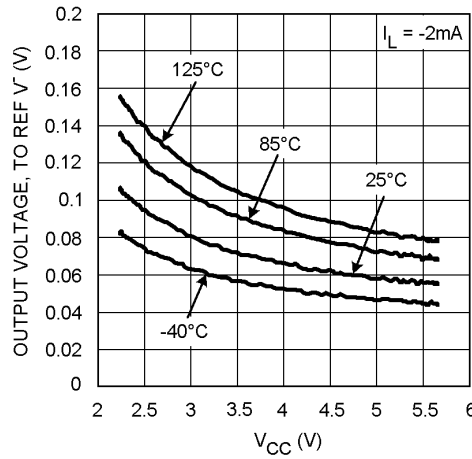

20037014

I\_SOURCE vs. V\_OUT

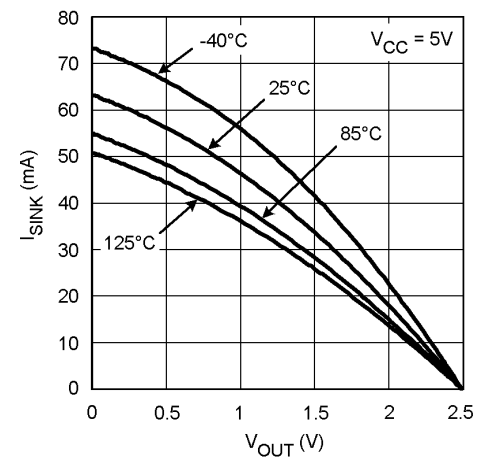

20037006

I\_SINK vs. V\_OUT

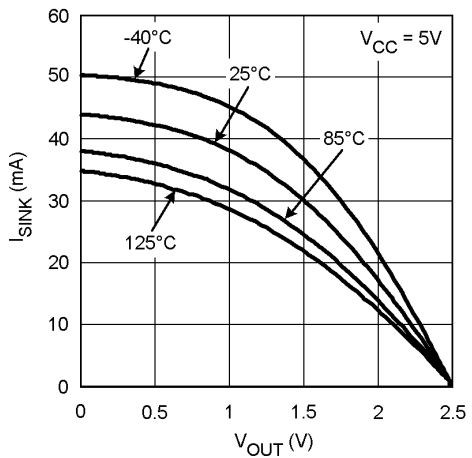

20037007

I\_SOURCE vs. V\_OUT

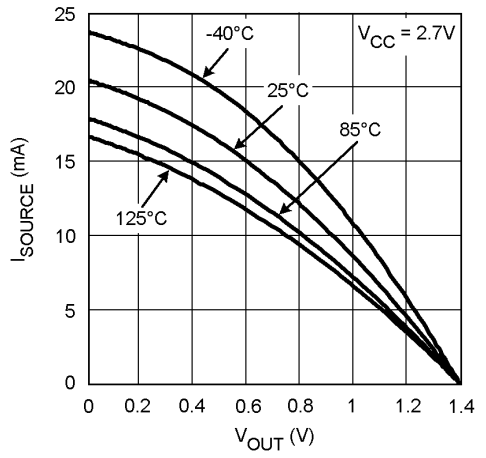

20037008

Typical Performance Characteristics (Continued)

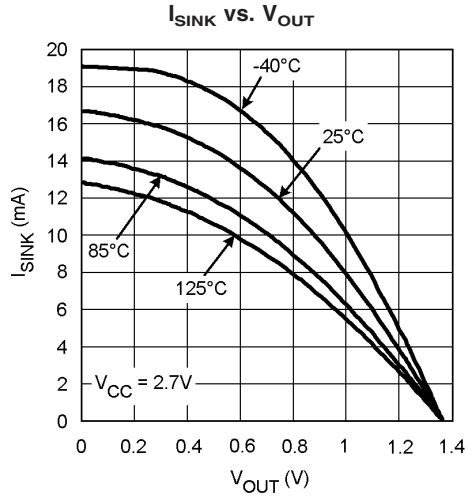

20037009

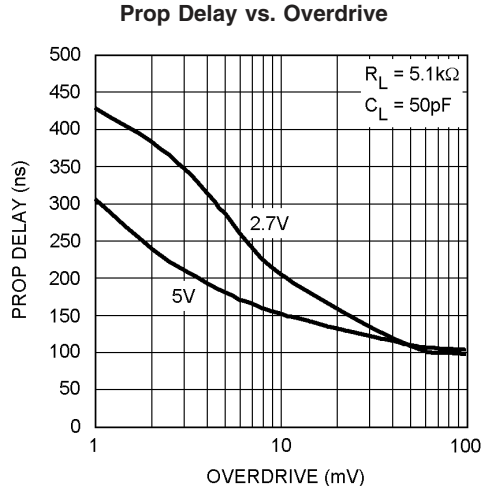

20037019

Response Time vs. Input Overdrives Positive Transition

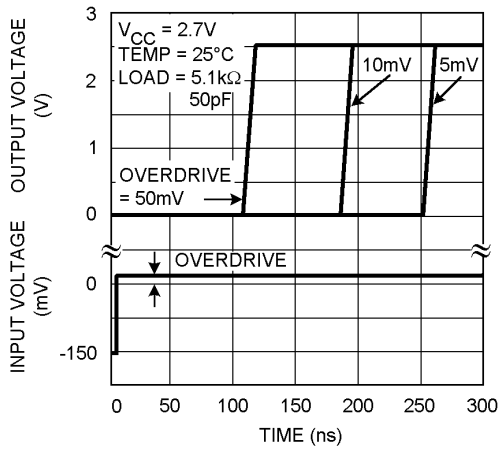

20037020

Response Time vs. Input Overdrives Positive Transition

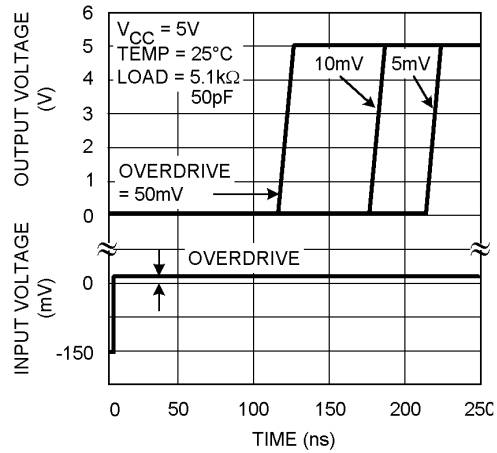

20037021

Response Time vs. Input Overdrives Negative Transition

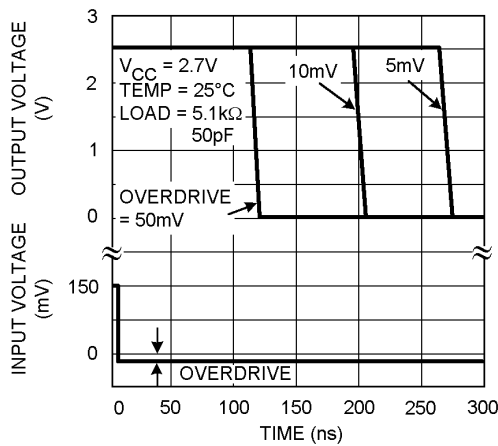

20037022

Response Time vs. Input Overdrives Negative Transition

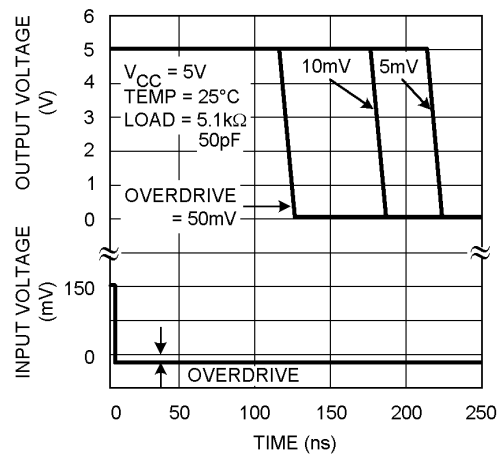

20037023

## Application Hints

### Basic Comparator

A basic comparator circuit is used to convert analog input signals to digital output signals. The comparator compares an input voltage ( $V_{IN}$ ) at the non-inverting input to the reference voltage ( $V_{REF}$ ) at the inverting pin. If  $V_{IN}$  is less than  $V_{REF}$  the output ( $V_O$ ) is low ( $V_{OL}$ ). However, if  $V_{IN}$  is greater than  $V_{REF}$ , the output voltage ( $V_O$ ) is high ( $V_{OH}$ ).

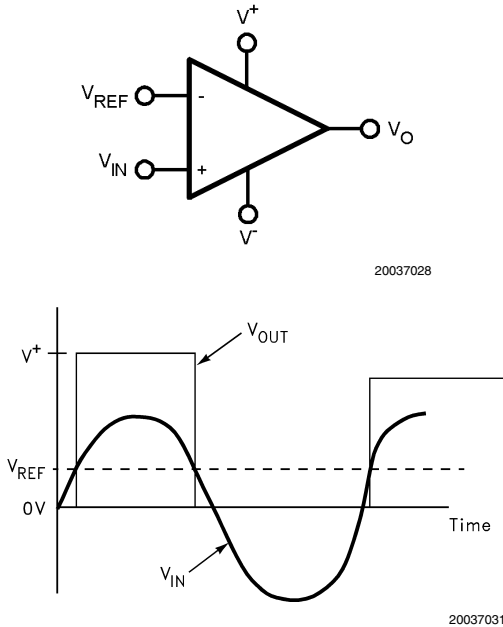

FIGURE 1. Basic Comparator

### Hysteresis

The basic comparator configuration may oscillate or produce a noisy output if the applied differential input is near the comparator's input offset voltage. This tends to occur when the voltage on one input is equal or very close to the other input voltage. Adding hysteresis can prevent this problem. Hysteresis creates two switching thresholds (one for the rising input voltage and the other for the falling input voltage). Hysteresis is the voltage difference between the two switching thresholds. When both inputs are nearly equal, hysteresis causes one input to effectively move quickly past the other. Thus, moving the input out of the region in which oscillation may occur.

Hysteresis can easily be added to a comparator in a non-inverting configuration with two resistors and positive feedback *Figure 2*. The output will switch from low to high when  $V_{IN}$  rises up to  $V_{IN1}$ , where  $V_{IN1}$  is calculated by

$$V_{IN1} = (V_{REF}(R_1+R_2))/R_2$$

The output will switch from high to low when  $V_{IN}$  falls to  $V_{IN2}$ , where  $V_{IN2}$  is calculated by

$$V_{IN2} = (V_{REF}(R_1+R_2) - V_{CC} R_1)/R_2$$

The Hysteresis is the difference between  $V_{IN1}$  and  $V_{IN2}$ .

$$\begin{aligned} \Delta V_{IN} &= V_{IN1} - V_{IN2} \\ &= ((V_{REF}(R_1+R_2))/R_2) - ((V_{REF}(R_1+R_2) - (V_{CC} R_1))/R_2) \\ &= V_{CC} R_1/R_2 \end{aligned}$$

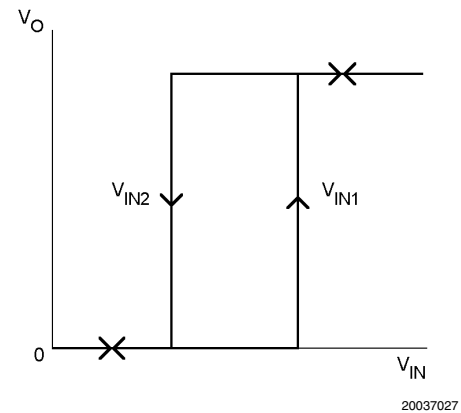
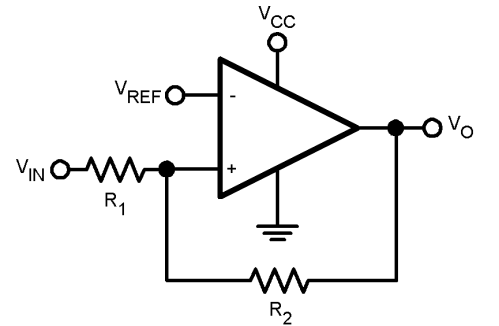

FIGURE 2. Non-Inverting Comparator Configuration

### Input

The LMV761/762 have near zero input bias current. This allows very high resistance circuits to be used without any concern for matching input resistances. This also allows the use of very small capacitors in R-C type timing circuits. This reduces the cost of the capacitors and amount of board space used.

### Shutdown Mode

The LMV761 features a low-power shutdown pin that is activated by driving  $\overline{SD}$  low. In shutdown mode, the output is in a high impedance state, supply current is reduced to 20nA and the comparator is disabled. Driving  $\overline{SD}$  high will turn the comparator on. The  $\overline{SD}$  pin should not be left unconnected due to the fact that it is a high impedance input. When left unconnected, the output will be at an unknown voltage. Also do not three-state the  $\overline{SD}$  pin.

The maximum input voltage for  $\overline{SD}$  is 5.5V, referred to ground and is not limited by  $V_{CC}$ . This allows the use of 5V logic to drive  $\overline{SD}$  while  $V_{CC}$  operates at a lower voltage, such as 3V. The logic threshold limits for  $\overline{SD}$  are proportional to  $V_{CC}$ .

### Board Layout and Bypassing

The LMV761/762 is designed to be stable and oscillation free, but it is still important to include the proper bypass capacitors and ground pickups. Ceramic 0.1 $\mu$ F capacitors should be placed at both supplies to provide clean switching. Minimize the length of signal traces to reduce stray capacitance.





**Physical Dimensions** inches (millimeters) unless otherwise noted (Continued)

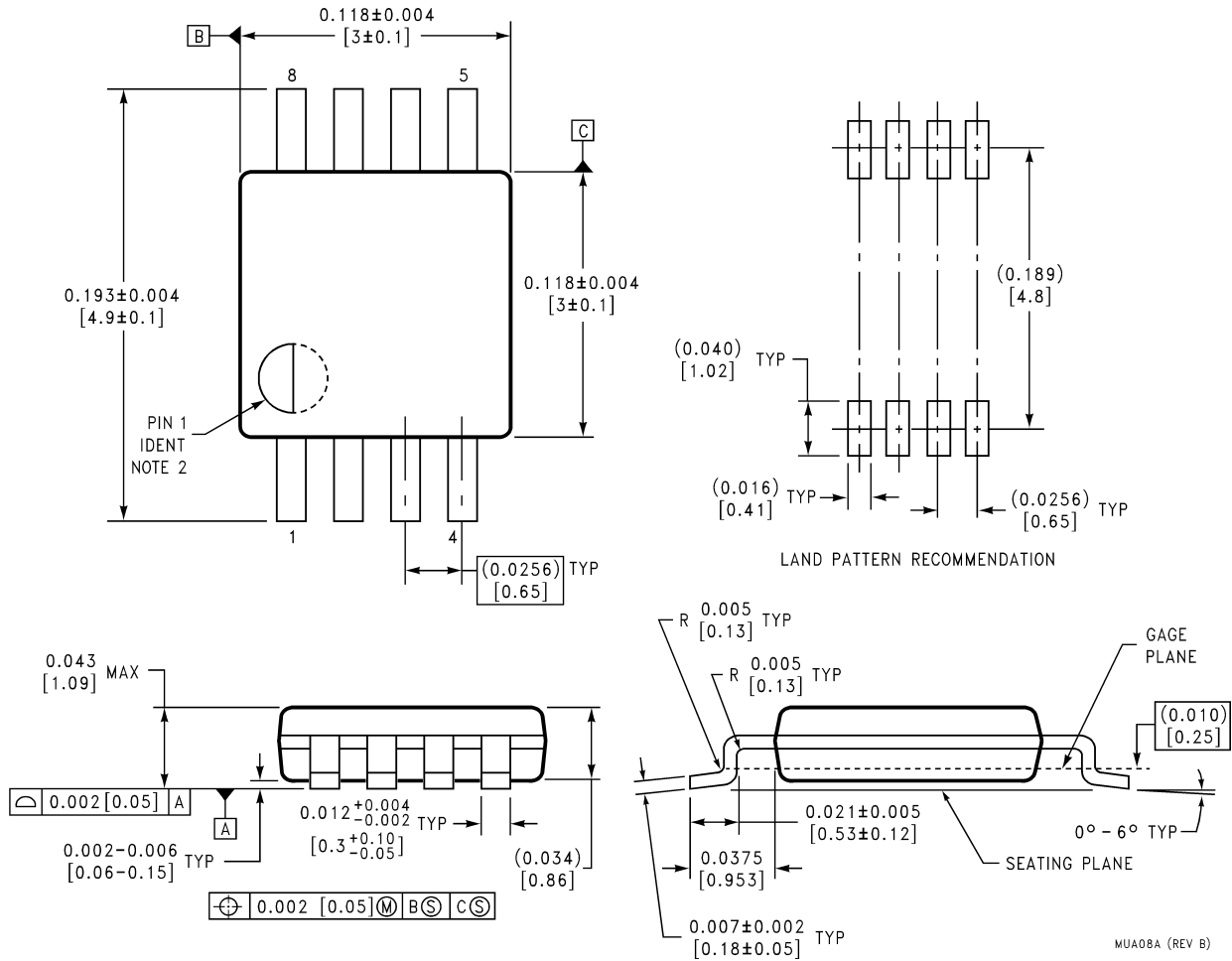

**8-Pin MSOP  
NS Package Number MUA08A**

MUA08A (REV B)

**LIFE SUPPORT POLICY**

NATIONAL'S PRODUCTS ARE NOT AUTHORIZED FOR USE AS CRITICAL COMPONENTS IN LIFE SUPPORT DEVICES OR SYSTEMS WITHOUT THE EXPRESS WRITTEN APPROVAL OF THE PRESIDENT AND GENERAL COUNSEL OF NATIONAL SEMICONDUCTOR CORPORATION. As used herein:

1. Life support devices or systems are devices or systems which, (a) are intended for surgical implant into the body, or (b) support or sustain life, and whose failure to perform when properly used in accordance with instructions for use provided in the labeling, can be reasonably expected to result in a significant injury to the user.
2. A critical component is any component of a life support device or system whose failure to perform can be reasonably expected to cause the failure of the life support device or system, or to affect its safety or effectiveness.

 **National Semiconductor Corporation**  
Americas  
Email: support@nsc.com

www.national.com

**National Semiconductor Europe**  
Fax: +49 (0) 180-530 85 86  
Email: europe.support@nsc.com  
Deutsch Tel: +49 (0) 69 9508 6208  
English Tel: +44 (0) 870 24 0 2171  
Français Tel: +33 (0) 1 41 91 8790

**National Semiconductor Asia Pacific Customer Response Group**  
Tel: 65-2544466  
Fax: 65-2504466  
Email: ap.support@nsc.com

**National Semiconductor Japan Ltd.**  
Tel: 81-3-5639-7560  
Fax: 81-3-5639-7507