

FEATURES

- **ON-CHIP LOW DISTORTION AMPLIFIER:**
IIP₃ = -1 dBm at minimum gain
- **WIDE AGC DYNAMIC RANGE:**
GCR = 42 dB TYP
- **ON-CHIP VIDEO AMPLIFIER:**
V_{OUT} = 1.0 V_{P-P} at single-ended output
- **SUPPLY VOLTAGE:**
V_{CC} = 5 V
- **PACKAGED IN 8 PIN SSOP SUITABLE FOR SURFACE MOUNTING**

APPLICATIONS

- Digital CATV
- Cable modem receivers
- IP Telephony receivers

DESCRIPTION

The UPC3219GV is a Silicon Monolithic IC designed for use as an AGC Amplifier for digital CATV, cable modem and IP telephony systems. This IC consists of a two stage gain control amplifier and a fixed gain video amplifier. The device provides a differential input and differential output for noise performance, which eliminates shielding requirements.

The package is 8-pin SSOP (Shrink Small Outline Package) suitable for surface mount.

This IC is manufactured using NEC's 10 GHz ft NESAT™ II AL silicon bipolar process. This process uses silicon nitride passivation film. This material can protect chip surface from external pollution and prevent corrosion/migration. Thus, this IC has excellent performance, uniformity and reliability.

NEC's stringent quality assurance and test procedures ensure the highest reliability and performance.

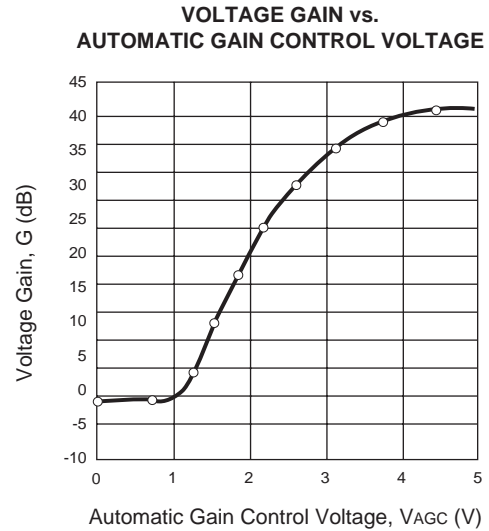

PACKAGE OUTLINE S08



All dimensions are typical unless specified otherwise.

ELECTRICAL CHARACTERISTICS

(T_A = 25°C, V_{CC} = 5 V, Z_S = 1KΩ, Z_L = 1KΩ, f_{IN} = 45 MHz, single-ended output), unless otherwise noted

PART NUMBER PACKAGE OUTLINE			UPC3219GV S08		
SYMBOLS	PARAMETERS AND CONDITIONS	UNITS	MIN	TYP	MAX
DC Characteristics					
I _{CC}	Circuit Current (no input signal)	mA	28	35	42
RF Characteristics					
BW	Frequency Bandwidth, V _{AGC} = 3 V ¹	MHz		100	
G _{MAX}	Maximum Gain, V _{AGC} = 4.5 V	dB	39	42	45
G _{MIN}	Minimum Gain, V _{AGC} = 0.5 V	dB	-4	0	4
GCR	Gain Control Range, V _{AGC} = 0.5 to 4.5 V	dB	35	42	—
NF _{AGC}	Noise Figure, V _{AGC} = 4.5 V at MAX Gain	dB	—	9	10.5
V _{OUT}	Output Voltage, Single Ended Output	V _{P-P}		1.0	
IM ₃	Third Order Intermodulation Distortion, f _{IN1} = 44 MHz, f _{IN2} = 45 MHz, V _{IN} = 30 dBmV per tone ²	dBc		55	

Note:

1. -3dB with respect to 10 MHz gain
2. V_{AGC} is adjusted to establish V_{OUT} = 1.0 V_{P-P} per tone

UPC3219GV

ABSOLUTE MAXIMUM RATINGS¹

(T_A = 25°C, unless otherwise specified)

SYMBOLS	PARAMETERS	UNITS	RATINGS
V _{CC}	Supply Voltage	V	6.0
P _D	Power Dissipation ² , T _A = 85°C	mW	250
T _{OP1}	Operating Ambient Temp.	°C	-40 to +85
T _{STG}	Storage Temperature	°C	-50 to +150

Notes:

1. Operation in excess of any one of these parameters may result in permanent damage.
2. Mounted on a 50 x 50 x 1.6 mm epoxy glass PWB, with copper patterning on both sides.

RECOMMENDED OPERATING CONDITIONS

SYMBOL	PARAMETER	UNITS	MIN	TYP	MAX
V _{CC}	Supply Voltage	V	4.5	5.0	5.5
T _A	Operating Ambient Temp. ¹	°C	-40	+25	+85
V _{AGC}	Gain Control Voltage Range	V	0.5	-	4.5
V _{IN}	Video Input Signal Range	dBmV	9		30

Note:

1. V_{CC} = 4.5 to 5.5 V

ORDERING INFORMATION

PART NUMBER	QUANTITY
UPC3219GV-E1	1 kp/reel

Note:

Embossed tape 8 mm wide. Pin 1 indicates pull-out direction of tape.

TYPICAL PERFORMANCE CURVES (T_A = 25°C, unless otherwise specified)

NOISE FIGURE vs. AUTOMATIC GAIN CONTROL VOLTAGE

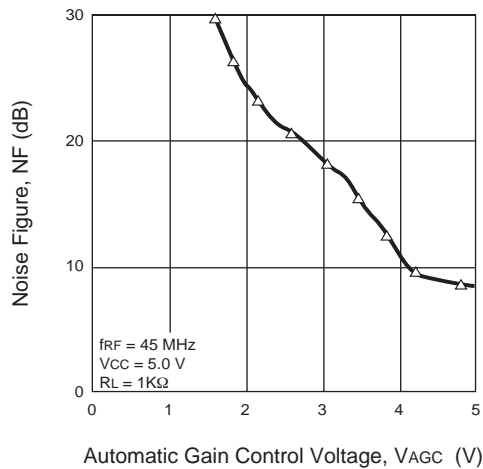

THIRD ORDER INTERMODULATION DISTORTION vs. INPUT VOLTAGE

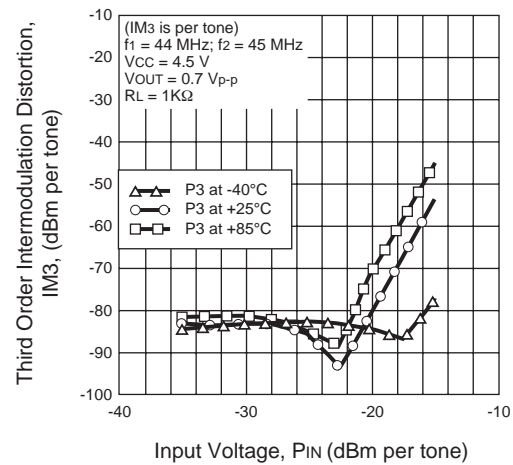

TYPICAL PERFORMANCE CURVES, cont. ($T_A = 25^\circ\text{C}$, unless otherwise specified)

SUPPLY CURRENT vs. SUPPLY VOLTAGE

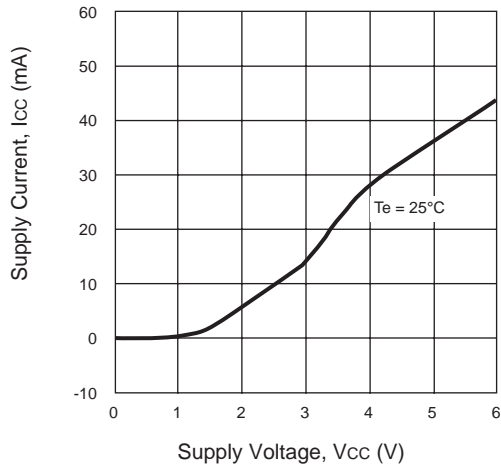

INPUT THIRD ORDER INTERCEPT POINT vs. INPUT POWER

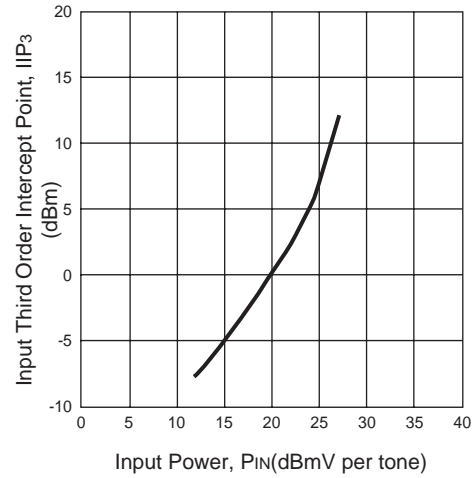

VOLTAGE GAIN vs. FREQUENCY

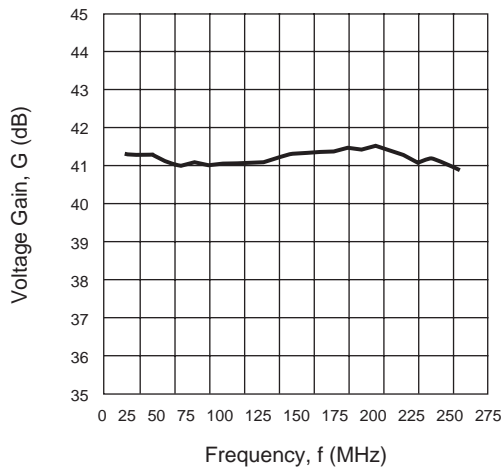

VOLTAGE OUTPUT vs. FREQUENCY

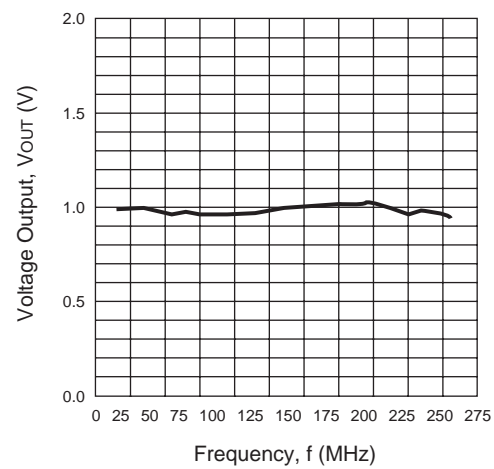

VOLTAGE GAIN vs. AUTOMATIC GAIN CONTROL VOLTAGE

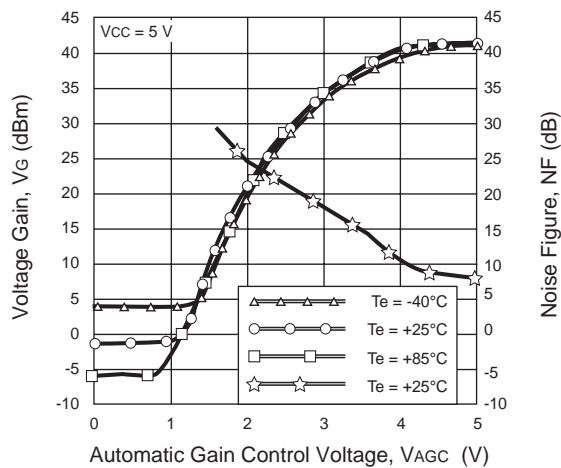

NOISE FIGURE vs. FREQUENCY

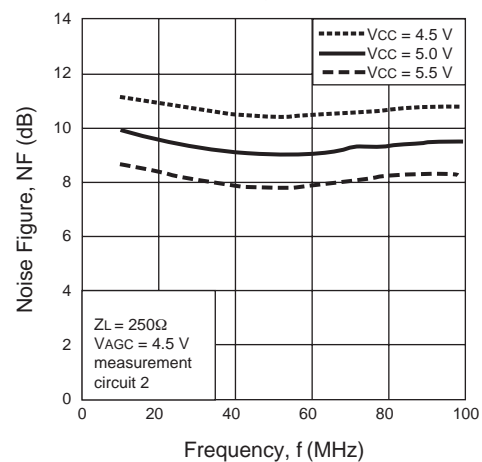

SYSTEM APPLICATION EXAMPLE

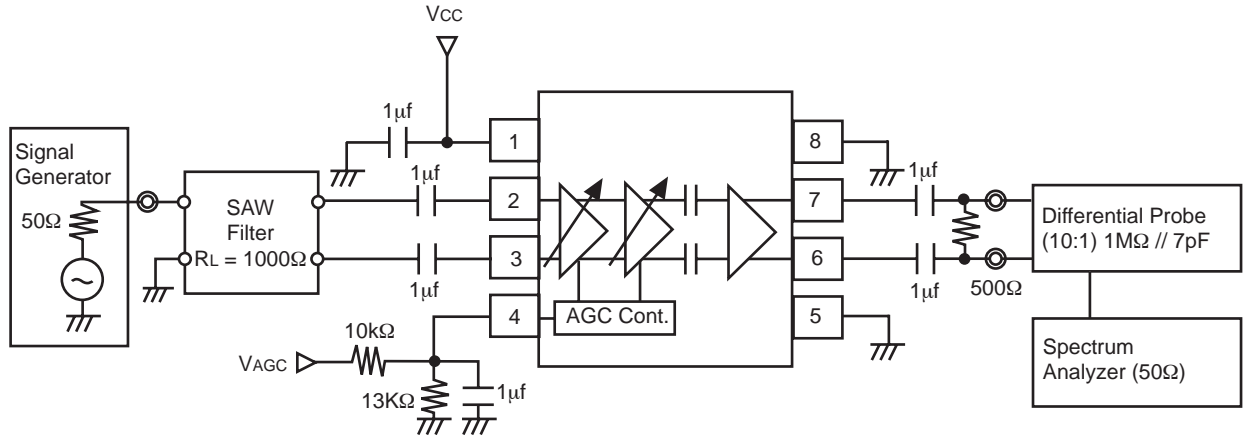

EVALUATION BOARD SCHEMATIC AND TEST

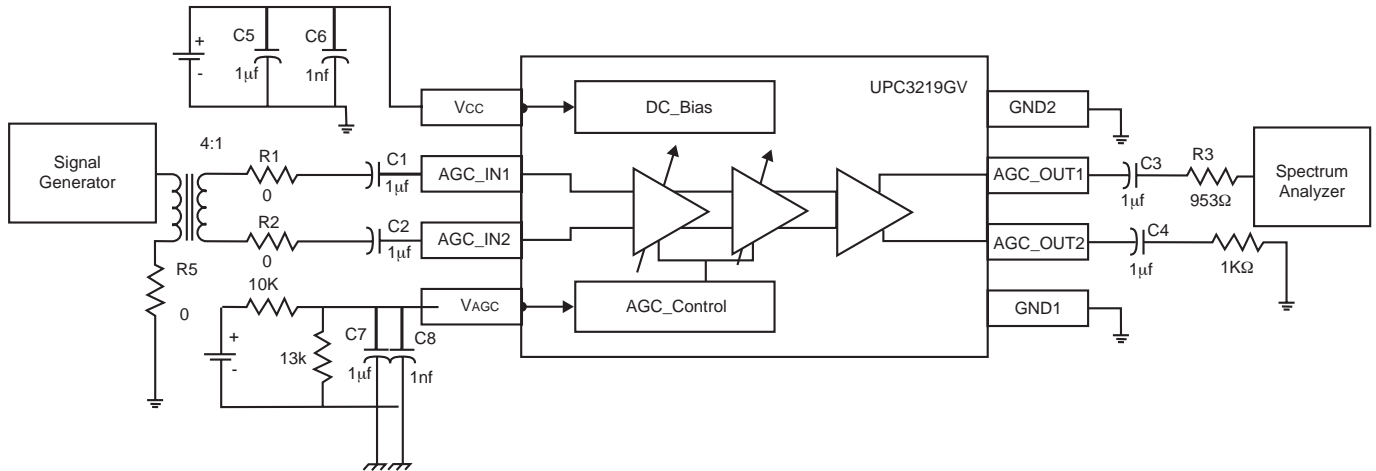

PIN EXPLANATIONS

Pin No.	Name	Applied Voltage (v)	Pin Voltage (v) ¹	Description	Internal Equivalent Circuit
1	Vcc	4.5 to 5.5		Power supply pin. This pin should be externally equipped with bypass capacitor to minimize ground impedance.	
2	INPUT1		1.45	Signal input pins of AGC amplifier.	
3	INPUT2		1.45		
4	VAGC	0 to Vcc		Gain control pin. This pin's bias govern the AGC output level. Minimum Gain at V _{AGC} = 0.5 V Maximum Gain at V _{AGC} = 4.5 V Recommended to use by dividing AGC voltage with external resistor (ex. 100k)	
5	GND 2	0		Ground pin. This pin should be connected to system ground with minimum inductance. Ground pattern on the board should be formed as wide as possible.	
6	OUTPUT2		2.2	Signal output pins of video amplifier	
7	OUTPUT1		2.2		
8	GND 1	0		Ground pin. This pin should be connected to system ground with minimum inductance. Ground pattern on the board should be formed as wide as possible. All ground pins must be connected together with wide ground pattern to decrease impedance difference.	

Note:

1. PIN is measured at V_{cc} = 5 V

OUTLINE DIMENSIONS (Units in mm)

EVALUATION BOARD

PACKAGE OUTLINE S08

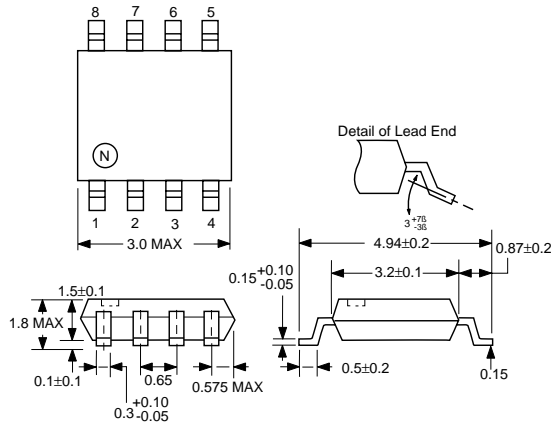

All dimensions are typical unless specified otherwise.

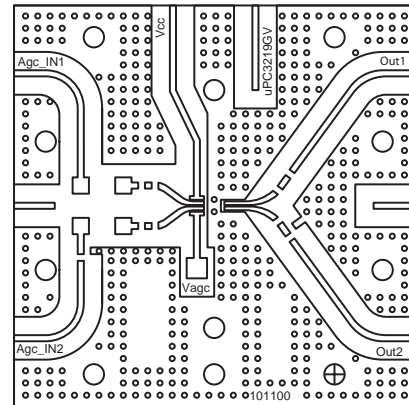

EVALUATION BOARD ASSEMBLY

INTERNAL BLOCK DIAGRAM

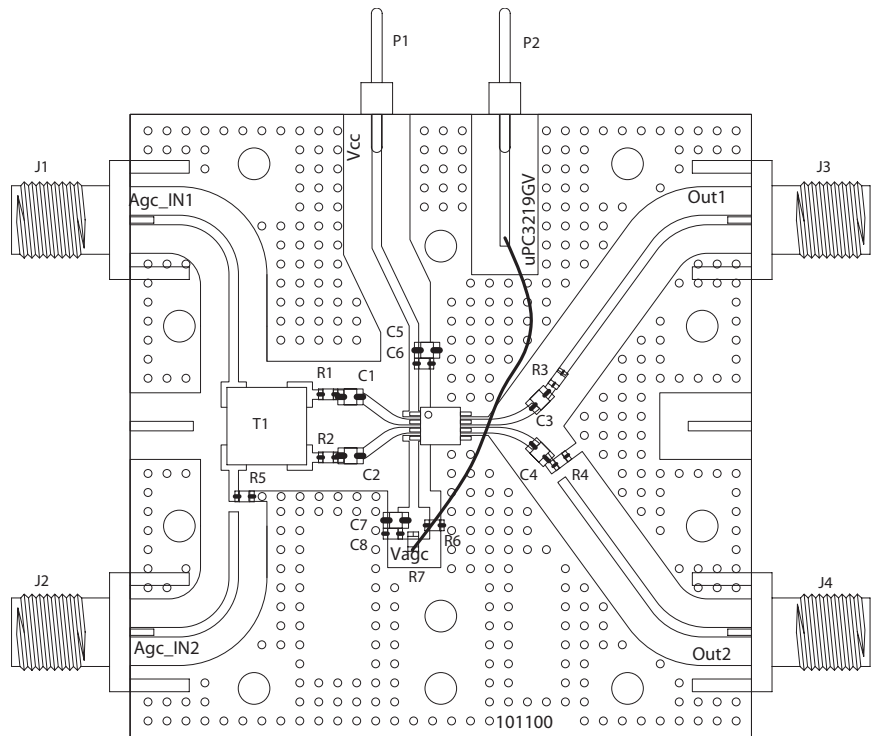
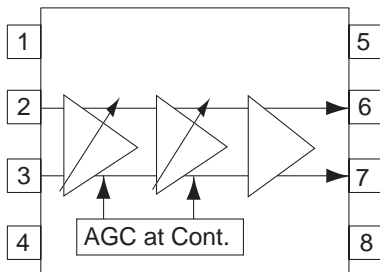

T1	Transformer 4:1 Coilcraft
R7	0603 10K OHM RES ROHM
R6	0603 13K OHM RES ROHM
R4	0603 1K OHM RES ROHM
R3	0603 953 OHM RES ROHM
R1,R2,R5	0603 0 OHM RES ROHM
C6, C8	0603 1000pF CAP ROHM
C1-C5, C7	0805 1uF CAP ROHM
U1	IC NEC, UPC3219GV IC NEC

Life Support Applications

These NEC products are not intended for use in life support devices, appliances, or systems where the malfunction of these products can reasonably be expected to result in personal injury. The customers of CEL using or selling these products for use in such applications do so at their own risk and agree to fully indemnify CEL for all damages resulting from such improper use or sale.

CEL California Eastern Laboratories, Your source for NEC RF, Microwave, Optoelectronic, and Fiber Optic Semiconductor Devices.

4590 Patrick Henry Drive • Santa Clara, CA 95054-1817 • (408) 988-3500 • FAX (408) 988-0279 • www.cel.com

DATA SUBJECT TO CHANGE WITHOUT NOTICE

05/29/2003