

Medium power transistor (−30V, −1.0A)

2SA2048

●Features

- 1) High speed switching. (T_f : Typ. : 20ns at $I_c = -1.0A$)
- 2) Low saturation voltage, typically
(Typ. : $-150mV$ at $I_c = -500mA$, $I_B = -50mA$)
- 3) Strong discharge power for inductive load and capacitance load.
- 4) Complements the 2SC5730

●Applications

Small signal low frequency amplifier
High speed switching

●Structure

PNP Silicon epitaxial planar transistor

●Packaging specifications

Type	Package	Taping
	Code	TL
	Basic ordering unit (pieces)	3000
2SA2048		○

●Absolute maximum ratings ($T_a=25^\circ C$)

Parameter	Symbol	Limits	Unit
Collector-base voltage	V_{CB0}	−30	V
Collector-emitter voltage	V_{CE0}	−30	V
Emitter-base voltage	V_{EB0}	−6	V
Collector current	I_c	−1.0	A
	I_{cP}	−2.0	A *1
Power dissipation	P_C	500	mW *2
Junction temperature	T_j	150	$^\circ C$
Range of storage temperature	T_{stg}	−55~+150	$^\circ C$

*1 $P_w=10ms$

*2 Each terminal mounted on a recommended land

●External dimensions (Units : mm)

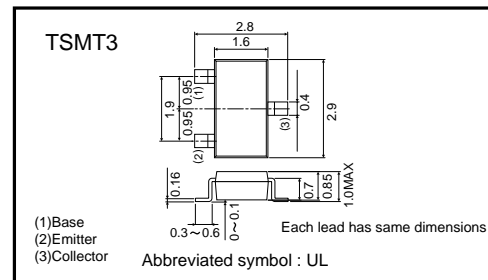

Transistor

●Electrical characteristics (Ta=25°C)

Parameter	Symbol	Min.	Typ.	Max.	Unit	Conditions
Collector-base breakdown voltage	BV _{CB0}	-30	-	-	V	I _C =-100μA
Collector-emitter breakdown voltage	BV _{CEO}	-30	-	-	V	I _C =-1mA
Emitter-base breakdown voltage	BV _{EB0}	-6	-	-	V	I _E =-100μA
Collector cut-off current	I _{CB0}	-	-	-1.0	μA	V _{CB} =-20V
Emitter cut-off current	I _{EB0}	-	-	-1.0	μA	V _{EB} =-4V
Collector-emitter saturation voltage	V _{CE(sat)}	-	-150	-300	mV	I _C =-500mA, I _B =-50mA
DC current gain	h _{FE}	120	-	390	-	V _{CE} =-2V, I _C =-10mA
Transition frequency	f _r	-	350	-	MHz	V _{CE} =-10V, I _E =100mA, f=10MHz
Collector output capacitance	C _{ob}	-	10	-	pF	V _{CB} =-10V, I _E =0A, f=1MHz
Turn-on time	T _{on}	-	30	-	ns	I _C =-1.0A I _{B1} =-0.1A
Storage time	T _{stg}	-	100	-	ns	I _{B2} =0.1A
Fall time	T _f	-	20	-	ns	V _{CC} ≅-25V

●h_{FE} RANK

Q	R
120-270	180-390

●Electrical characteristic curves

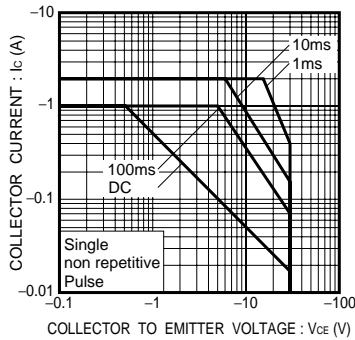

Fig.1 Safe Operating Area

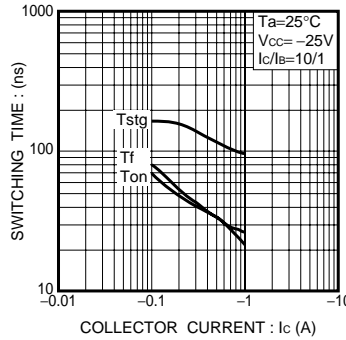

Fig.2 Switching Time

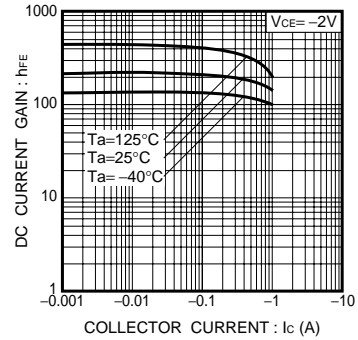

Fig.3 DC Current Gain vs. Collector Current (I)

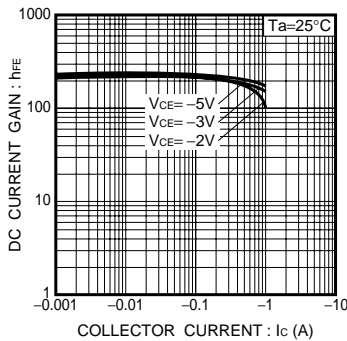

Fig.4 DC Current Gain vs. Collector Current (II)

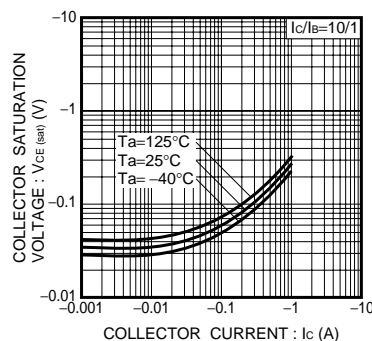

Fig.5 Collector-Emitter Saturation Voltage vs. Collector Current (I)

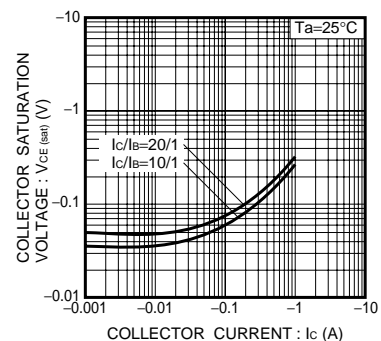

Fig.6 Collector-Emitter Saturation Voltage vs. Collector Current (II)

Transistor

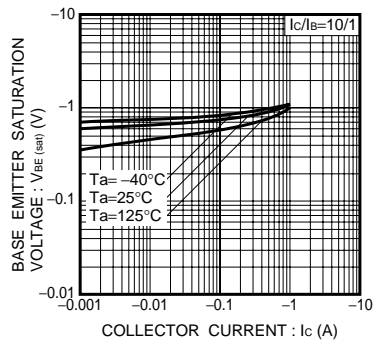

Fig.7 Base-Emitter Saturation Voltage vs. Collector Current

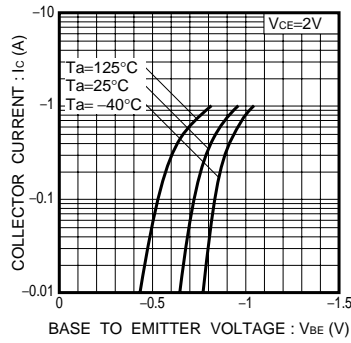

Fig.8 Grounded Emitter Propagation Characteristics

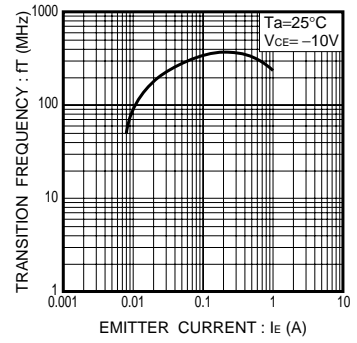

Fig.9 Transition Frequency

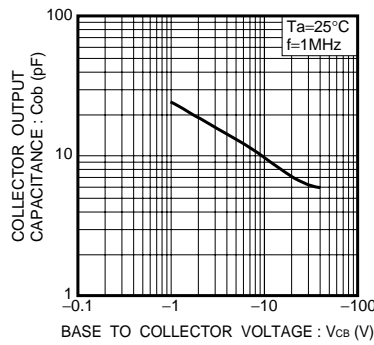
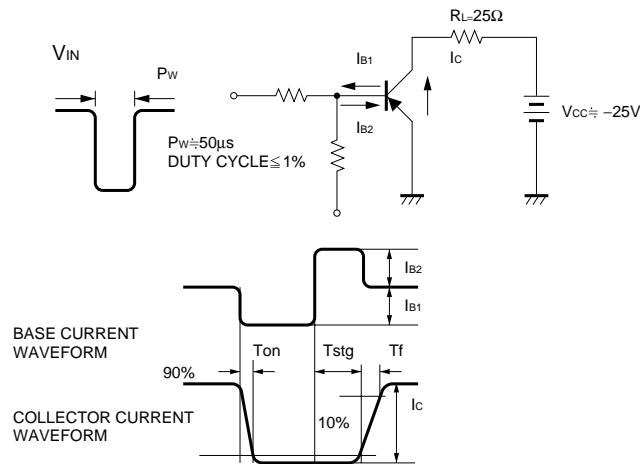

Fig.10 Collector Output Capacitance

●Switching characteristics measurement circuits



This datasheet has been download from:

www.datasheetcatalog.com

Datasheets for electronics components.