

SPECIFICATION FOR APPROVAL

REF : 20090122-B

PAGE: 1

PROD. NAME	SMD POWER INDUCTOR	ABC'S DWG NO.	SR0503□□□□L□-□□□
		ABC'S ITEM NO.	

I . CONFIGURATION & DIMENSIONS :

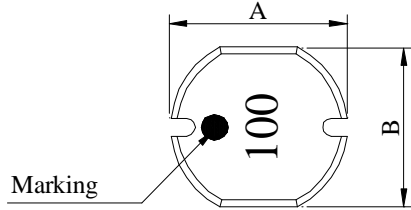

- A : 5.0±0.3 m/m
- B : 4.5±0.3 m/m
- C : 3.0±0.3 m/m
- D : 2.0 ref. m/m
- G : 1.9 ref. m/m
- H : 5.0 ref. m/m
- I : 1.8 ref. m/m

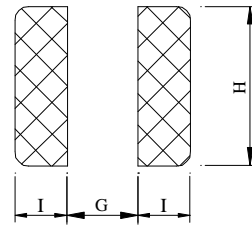
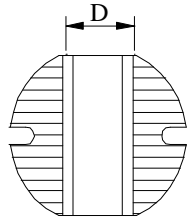
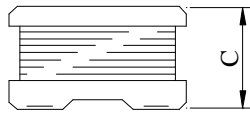

(PCB Pattern)

II . SCHEMATIC DIAGRAM :



III . MATERIALS :

- a . Core : Ferrite DR core
- b . Wire : Enamelled copper wire (class F & classH)
- c . Terminal : Ag/Ni/Sn
- d . Remark : Products comply with RoHS' requirements

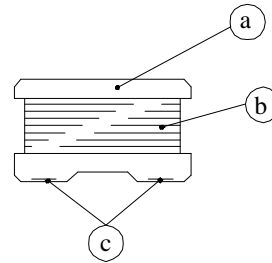

Peak Temp : 260°C max.
 Max time above 230°C : 50sec max.
 Max time above 200°C : 70sec max.

IV . GENERAL SPECIFICATION :

- a . Temp. rise : 40°C max.
- b . Rated current : Base on temp. rise & ΔL / LOA=10% max.
- c . Storage temp. : -40°C ----+125°C
- d . Operating temp. : -40°C ----+125°C
- e . Resistance to solder heat : 260°C.10 secs.

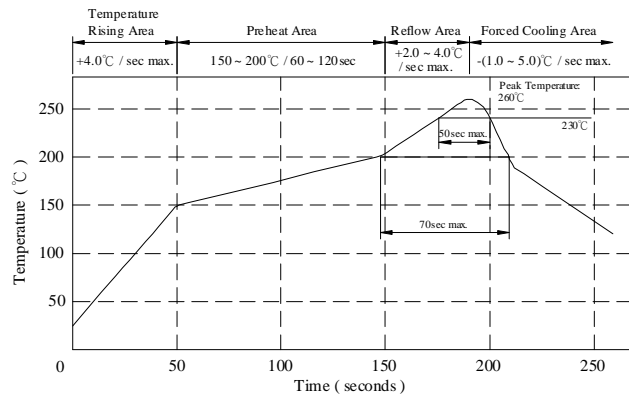

AR-001A

SPECIFICATION FOR APPROVAL

REF : 20090122-B

PAGE: 2

PROD. NAME	SMD POWER INDUCTOR	ABC'S DWG NO.	SR0503□□□□L□-□□□
		ABC'S ITEM NO.	

V . ELECTRICAL CHARACTERISTICS :

DWG No.	Inductance (μH)	Q ref.	Test Freq. (Hz)		SRF (MHz) nom	RDC (Ω) max.	IDC (A) max.
			L	Q			
SR0503R50YL□-□□□	0.5±30%	28	7.96M	7.960M	40.00	0.012	4.000
SR05031R0ML□-□□□	1.0±20%	28	7.96M	7.960M	40.00	0.016	3.000
SR05031R2ML□-□□□	1.2±20%	28	7.96M	7.960M	39.00	0.020	2.800
SR05031R8ML□-□□□	1.8±20%	28	7.96M	7.960M	38.00	0.030	2.500
SR05032R7ML□-□□□	2.7±20%	28	7.96M	7.960M	38.00	0.040	2.100
SR05033R3ML□-□□□	3.3±20%	25	7.96M	7.960M	37.00	0.056	1.900
SR05033R9ML□-□□□	3.9±20%	25	7.96M	7.960M	36.00	0.062	1.850
SR05034R7ML□-□□□	4.7±20%	25	7.96M	7.960M	35.00	0.068	1.700
SR05035R6ML□-□□□	5.6±20%	25	7.96M	7.960M	34.00	0.072	1.600
SR05036R8ML□-□□□	6.8±20%	25	7.96M	7.960M	33.00	0.088	1.450
SR05038R2ML□-□□□	8.2±20%	20	7.96M	7.960M	32.00	0.099	1.350
SR0503100ML□-□□□	10.0±20%	20	1K	2.520M	30.00	0.130	1.300
SR0503120ML□-□□□	12.0±20%	20	1K	2.520M	29.00	0.160	1.200
SR0503150ML□-□□□	15.0±20%	20	1K	2.520M	27.00	0.190	1.050
SR0503180ML□-□□□	18.0±20%	20	1K	2.520M	24.00	0.210	0.950
SR0503220ML□-□□□	22.0±20%	20	1K	2.520M	22.00	0.280	0.900
SR0503270ML□-□□□	27.0±20%	20	1K	2.520M	20.00	0.320	0.800
SR0503330KL□-□□□	33.0±10%	15	1K	2.520M	17.50	0.380	0.700
SR0503390KL□-□□□	39.0±10%	15	1K	2.520M	17.00	0.420	0.650
SR0503470KL□-□□□	47.0±10%	20	1K	2.520M	14.00	0.600	0.600
SR0503560KL□-□□□	56.0±10%	20	1K	2.520M	13.00	0.710	0.500
SR0503680KL□-□□□	68.0±10%	20	1K	2.520M	12.00	0.760	0.450
SR0503820KL□-□□□	82.0±10%	15	1K	2.520M	10.00	0.880	0.420
SR0503101KL□-□□□	100.0±10%	40	1K	0.796M	8.50	1.600	0.400
SR0503121KL□-□□□	120.0±10%	40	1K	0.796M	8.00	1.700	0.370
SR0503151KL□-□□□	150.0±10%	40	1K	0.796M	7.20	2.000	0.330
SR0503181KL□-□□□	180.0±10%	40	1K	0.796M	6.90	2.300	0.300
SR0503221KL□-□□□	220.0±10%	35	1K	0.796M	6.20	2.500	0.250
SR0503271KL□-□□□	270.0±10%	35	1K	0.796M	5.70	2.900	0.230
SR0503331KL□-□□□	330.0±10%	30	1K	0.796M	5.30	3.300	0.210
SR0503391KL□-□□□	390.0±10%	30	1K	0.796M	4.90	3.700	0.190
SR0503471KL□-□□□	470.0±10%	30	1K	0.796M	4.60	4.900	0.180
SR0503561KL□-□□□	560.0±10%	30	1K	0.796M	4.20	5.700	0.160
SR0503681KL□-□□□	680.0±10%	30	1K	0.796M	3.90	7.500	0.140
SR0503821KL□-□□□	820.0±10%	40	1K	0.796M	3.30	10.000	0.120
SR0503102KL□-□□□	1000.0±10%	40	1K	0.252M	3.10	11.500	0.110
SR0503122JL□-□□□	1200.0± 5%	40	1K	0.252M	3.00	12.000	0.063
SR0503152JL□-□□□	1500.0± 5%	40	1K	0.252M	2.40	13.000	0.059
SR0503182JL□-□□□	1800.0± 5%	40	1K	0.252M	2.20	15.000	0.055
SR0503222JL□-□□□	2200.0± 5%	40	1K	0.252M	2.30	22.000	0.053

AR-001A



SPECIFICATION FOR APPROVAL

REF : 20090122-B

PAGE: 3

PROD. NAME	SMD POWER INDUCTOR	ABC'S DWG NO.	SR0503□□□□L□-□□□
		ABC'S ITEM NO.	

DWG No.	Inductance (μH)	Q ref.	Test Freq. (Hz)		SRF (MHz) nom	RDC (Ω) max.	IDC (A) max.
			L	Q			
SR0503272JL□-□□□	2700.0± 5%	40	1K	0.252M	2.10	26.000	0.050
SR0503332JL□-□□□	3300.0± 5%	40	1K	0.252M	1.90	38.000	0.045
SR0503392JL□-□□□	3900.0± 5%	40	1K	0.252M	1.50	40.000	0.042
SR0503472JL□-□□□	4700.0± 5%	40	1K	0.252M	1.40	48.000	0.040
SR0503562JL□-□□□	5600.0± 5%	40	1K	0.252M	1.30	72.000	0.038
SR0503682JL□-□□□	6800.0± 5%	40	1K	0.252M	1.20	80.000	0.034
SR0503822JL□-□□□	8200.0± 5%	40	1K	0.252M	1.00	92.000	0.030
SR0503103JL□-□□□	10000.0± 5%	30	1K	79.60K	0.95	110.000	0.027
SR0503123JL□-□□□	12000.0± 5%	30	1K	79.60K	0.85	148.000	0.025
SR0503153JL□-□□□	15000.0± 5%	30	1K	79.60K	0.80	168.000	0.020

- 1). □ : Packaging information... [A]: Bulk [B]: Taping Reel
 2). "- □□□": Reference code

VI . INDUCTANCE VS. DC CURRENT CURVE :

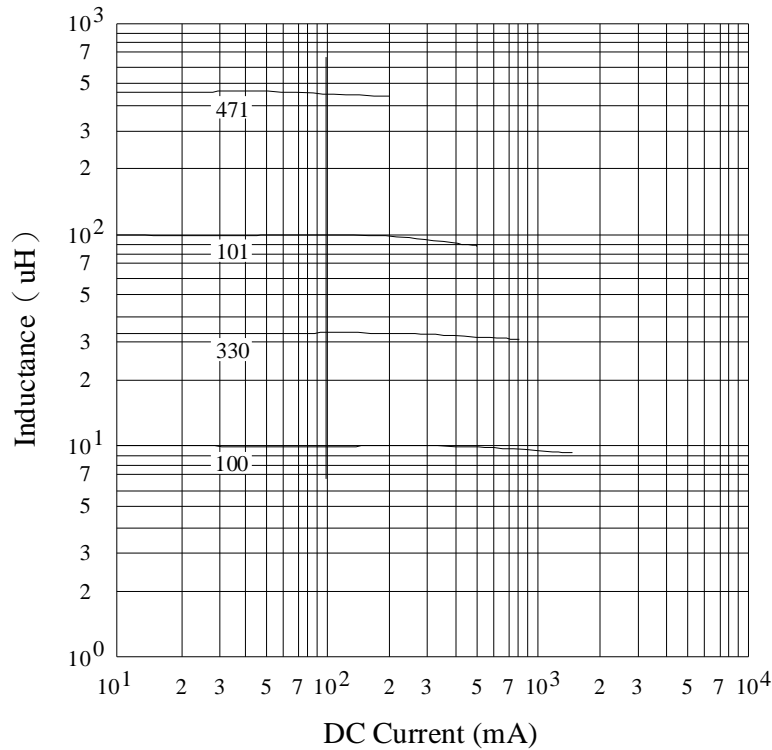

AR-001A



SPECIFICATION FOR APPROVAL

REF : 20090122-B

PAGE: 4

PROD. NAME	SMD POWER INDUCTOR	ABC'S DWG NO.	SR0503□□□□L□-□□□
		ABC'S ITEM NO.	

VII . PACKAGING INFORMATION :

(1) Configuration

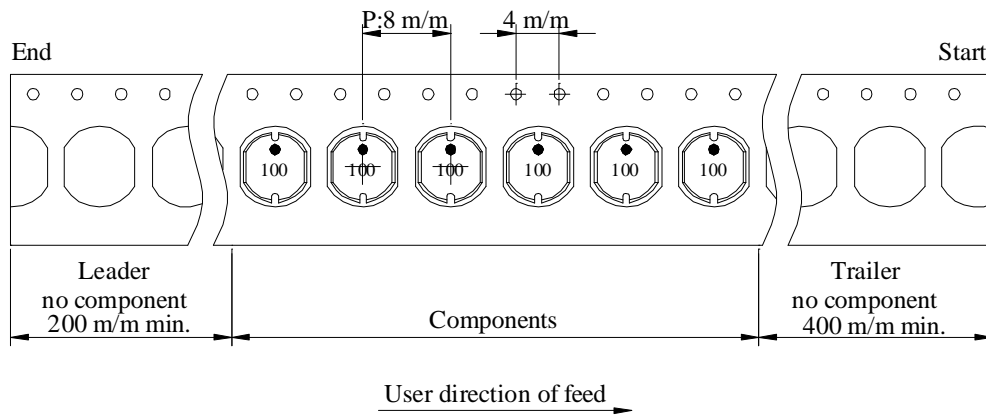
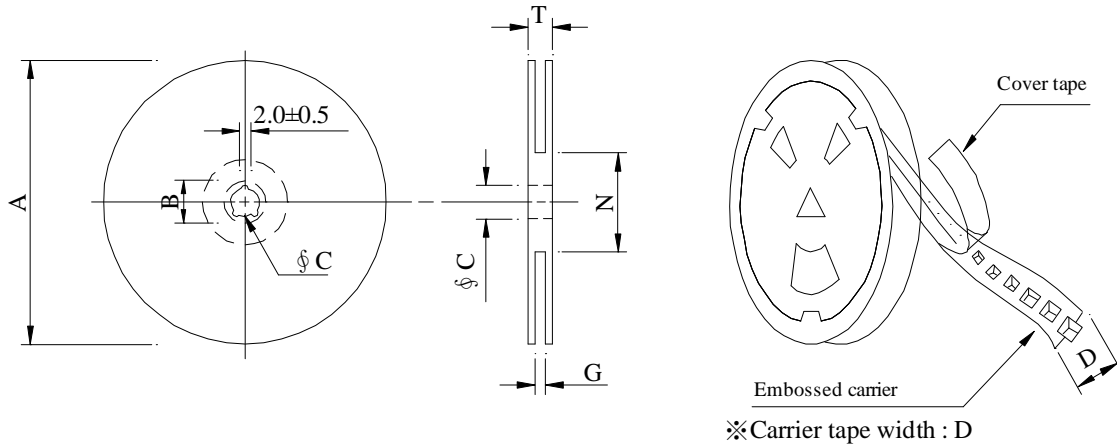

(2) Dimensions

Unit:m/m

Style	A	B	C	D	G	N	T
07 - 12	178	21±0.8	13	12	14 ⁺⁰	50 ⁻⁰	16.5
13 - 12	330	21±0.8	13±0.5	12	14 ⁺⁰	50 ⁻⁰	18.4

(3) Q'TY & G.W. PER PACKAGE

Series	Inner : Reel			Outer : Carton		
	Q'TY (pcs)	G.W. (gw)	Style	Q'TY (pcs)	G.W. (Kg)	Size (cm)
SR0503	500	275	07 - 12	20,000	11.8	42 x 41 x 24
SR0503	2000	1185	13 - 12	16,000	10.3	40 x 40 x 24

AR-001A



SPECIFICATION FOR APPROVAL

REF : 20090122-B

PAGE: 6

PROD. NAME	SMD POWER INDUCTOR	ABC'S DWG NO.	SR0503□□□□L□-□□□
		ABC'S ITEM NO.	

IX . RELIABILITY TEST :

Test item	Specification	Test condition						
Solderability	More than 95% of the terminal electrode shall be covered With fresh solder.	Preheat : 155°C / 4 hours. Solder : Sn96.5 / Ag3 / Cu0.5 or equivalent Solder temp. : 235±5°C Flux : Rosin Dip time : 5±0.5 seconds						
Thermal shock test (Temp. cycle)	Electrical oharacteristics shall not change more than ±20%	<table style="width: 100%; border: none;"> <tr> <td style="text-align: center;">Room temp. 15 minutes</td> <td style="text-align: center; vertical-align: middle;">→</td> <td style="text-align: center;">-40 °C 30 minutes</td> </tr> <tr> <td style="text-align: center;">Room temp. 15 minutes</td> <td style="text-align: center; vertical-align: middle;">→</td> <td style="text-align: center;">+125 °C 30 minutes</td> </tr> </table> <p>Total : 50 cycles</p>	Room temp. 15 minutes	→	-40 °C 30 minutes	Room temp. 15 minutes	→	+125 °C 30 minutes
Room temp. 15 minutes		→	-40 °C 30 minutes					
Room temp. 15 minutes		→	+125 °C 30 minutes					
Humidity test		Temperature : 40±2°C Humidity : 90±5% Time : 1000 hours						
High temp. Resistance test	Temperature : 125±5°C Applied current : Per spec. Time : 96 hours							

AR-001A



SPECIFICATION FOR APPROVAL

REF : 20090122-B

PAGE: 7

PROD. NAME	SMD POWER INDUCTOR	ABC'S DWG NO.	SR0503□□□□L□-□□□
		ABC'S ITEM NO.	

X . UL CARD :

OBMW2 September 8, 2000
Magnet Wire-Component

JUNG SHING WIRE CO LTD E174837
231 CHUNG CHENG RD, SEC 3 JEN-TEH HSIANG, TAINAN
HSIEN TAIWAN

Mtl Dsg	Mark Dsg	BC	Coat Typ	OC	ANSI Type	Temp Class
AIW	---	Polyamideimide	---	---	MW81-C	220
CFUEWB	---	Polyurethane	---	---	MW75C	130
EIAIW	---	Polyesterimide	---	Polyamideimide	MW35C	200
EILOCKY	---	Polyesterimide	---	Polyamide	---	180
EILOCKW	---	Polyesterimide	---	Modified Epoxy	---	200
EIW	---	Polyesterimide	---	---	---	220
EIW-2	---	Polyesterimide	---	---	MW74-C	200
FL.EILOCKY	---	Modified Polyester	---	Polyamide	---	155
LSFFW	---	Polyurethane	---	---	MW79-C	155
LSUEW	---	Polyurethane	---	---	---	130
PEW	---	Polyester	---	---	---	155
PEY	---	Polyester	---	Nylon	MW24-C	155
SF.FLW	---	Modified Polyester	---	---	MW26C	155
SF.EIW	---	Polyesterimide	---	---	MW77C	180
SF.BY@	---	Modified Polyester	---	Nylon	MW27-C	155
SF.FLY@	---	Modified Polyester	---	Nylon	MW27-C	155
SF.BLOCKBS	---	Modified Polyester	---	Modified Polyamide	---	155
SF.EILOCKY#	---	Polyesterimide	---	Polyamide	---	180
SF.EILOCKBS	---	Polyesterimide	---	Modified Polyamide	---	180
SF.BW@	---	Modified Polyester	---	---	MW26C	155
SFFW	---	Polyurethane	---	---	MW79	155

A not-for-profit organization
dedicated to public safety and
committed to quality service

287806002 Page 1 of 2

Mtl Dsg	Mark Dsg	BC	Coat Typ	OC	ANSI Type	Temp Class
SFFY	---	Polyurethane	---	Polyamide	MW80C	155
UEW-1	---	Polyurethane	---	---	MW2-C	105
UEW-2	---	Polyurethane	---	---	---	130
UEW-4	---	Polyurethane	---	---	MW75C	130
UEY	---	Polyurethane	---	Nylon	MW28-C	130
UEY-2	---	Polyurethane	---	Polyamide	MW28-C	130

@-May be suffixed by LZ; # - May be suffixed by LZ, EL or LZL.
LZ - Signifies magnd wires twisted together; EL - signifies base coated magnet wire laid parallel with top coat applied overall; LZL - signi-
fies base coated magnet wire twisted together and covered with top coat overall.

Marking: Company name or trademarks JSW or 榮星電線 , material designation or marked designation on packaed or reel, and
Recognized Component Mark.

See General Information Preceding These Recognitions
For use only in equipment where the acceptability of the combination is determined by Underwriters Laboratories Inc.

287806002 Page 2 of 2 OBMW2/E174837
September 8, 2000

AR-001A

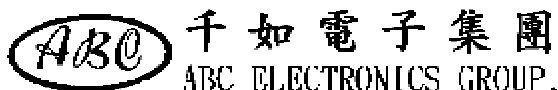

SPECIFICATION FOR APPROVAL

REF : 20090122-B

PAGE: 8

PROD. NAME	SMD POWER INDUCTOR	ABC'S DWG NO. ABC'S ITEM NO.	SR0503□□□□L□-□□□
---------------	---------------------------	-------------------------------------	------------------

OBMW2 October 06, 2005

Magnet Wire-Component

ELEKTRISOLA (MALAYSIA) SDN BHD E143312

JALAN DAMAI SATU JANDA BAIK 28750 BENTONG, PAHANG
DARUL MAKMUR MALAYSIA

Mtl Dsg	Mark Dsg	Coating Type	ANSI Typ	Temp Class
		BC	OC	
Estersol 180	E180	Polyesterimide (solderable)	---	MW-77 180
Amldester 200	A200	Polyesterimide	---	MW-74 200
Polysol-N 155	PN155	Polyurethane	Nylon	MW-80, 155, 130
Polysol 155	P155, G155	Polyurethane	---	MW-28 130
Polysol 155g	Pg155	Polyurethane	---	MW-79, 155, 130
Polysol 155p	Pp155, Gp155	Polyurethane	---	MW-75 130
Polysol 160	P160	Polyurethane	---	MW-79 155
Polysol 180	P180, G180	Polyurethane	---	MW-79 155
Polysol 170	P170 or G170	Polyurethane	---	MW-82 180
Polysol-N 180	PN180	Polyurethane	Nylon	MW-79 155
Polysol P155p	P155p	Polyurethane	---	MW-83 180
			---	MW-79 155

Marking : Company name, material designation or marked designation and factory identification on package ok reel

See General Information preceding These Recognitions

For use only in equipment where the acceptability of the combination is determined by Underwriters Laboratories Inc.