

3-Pin One-Cell Step-Up DC/DC Converter

FEATURES

- A Guaranteed Start-Up from less than 0.9 V.
- High Efficiency.
- Low Quiescent Current.
- Less Number of External Components needed.
- Low Ripple and Low Noise.
- Fixed Output Voltage: 2.7V, 3.0V, 3.3V, and 5V.
- Space Saving Packages: SOT-89 and TO-92

APPLICATIONS

- Pagers.
- Cameras.
- Wireless Microphones.
- Pocket Organizers.
- Battery Backup Suppliers.
- Portable Instruments.

DESCRIPTION

The AIC1642 is a high efficiency step-up DC/DC converter for applications using 1 to 4 battery cells. Only three external components are required to deliver a fixed output voltage of 2.7V, 3.0V, 3.3V, or 5V. The AIC1642 starts up from less than 0.9V input with 1mA load. Pulse Frequency Modulation scheme brings optimized performance for applications with light output loading and low input voltages. The output ripple and noise are lower compared with the circuits operating in PSM mode.

The PFM control circuit operating in 100KHz (max.) switching rate results in smaller passive components. The space saving SOT-89 and TO-92 packages make the AIC1642 is an ideal choice of DC/DC converter for space conscious applications, like pagers, electronic cameras, and wireless microphones.

TYPICAL APPLICATION CIRCUIT

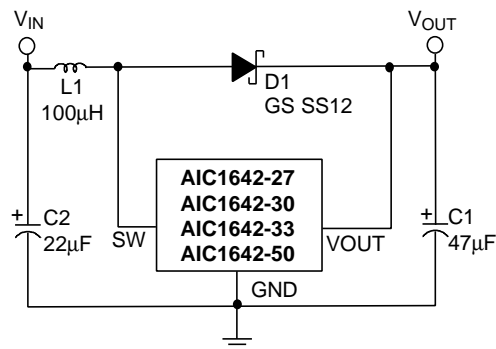

One Cell Step-Up DC/DC Converter

ORDERING INFORMATION

AIC1642-XXCXXX

PACKING TYPE
 TR: TAPE & REEL
 TB: TUBE
 BG: BAG

PACKAGE TYPE
 X: SOT-89
 Z: TO-92

OUTPUT VOLTAGE
 27: 2.7V
 30: 3.0V
 33: 3.3V
 50: 5.0V

Example: AIC1642-27COTR
 → 2.7V Version, in MSOP8 Package
 & Tape & Reel Packing Type

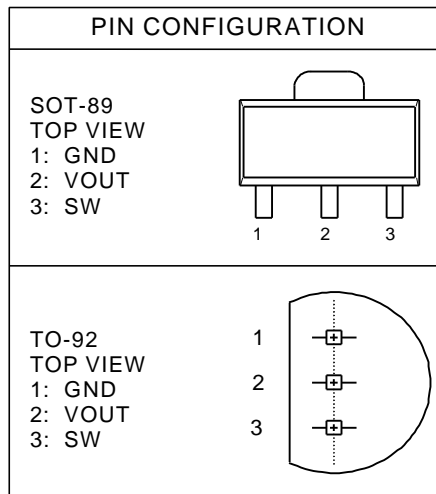

ABSOLUTE MAXIMUM RATINGS

Supply Voltage	12V
SW pin Voltage	12V
SW pin Switch Current	0.6A
Operating Temperature Range	-40°C to 85°C
Storage Temperature Range	-65°C to 150 °C
Lead Temperature (Soldering 10 Sec.)	260°C

TEST CIRCUIT

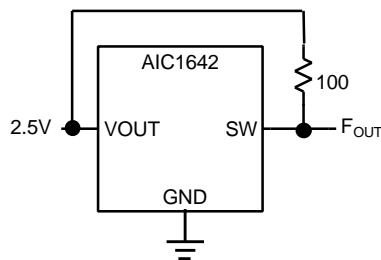

Oscillator Test Circuit

ELECTRICAL CHARACTERISTICS ($T_A=25^{\circ}\text{C}$, $I_{OUT}=10\text{mA}$, Unless otherwise specified)

PARAMETER	TEST CONDITIONS	SYMBOL	MIN.	TYP.	MAX.	UNIT
Output Voltage	$V_{IN}=1.8\text{V}$, AIC1642-27	V_{OUT}	2.633	2.700	2.767	V
	$V_{IN}=1.8\text{V}$, AIC1642-30		2.925	3.000	3.075	
	$V_{IN}=2.0\text{V}$, AIC1642-33		3.218	3.300	3.382	
	$V_{IN}=3.0\text{V}$, AIC1642-50		4.875	5.000	5.125	
Input Voltage		V_{IN}			8	V
Start-Up Voltage	$I_{OUT}=1\text{mA}$, $V_{IN}:0 \rightarrow 2\text{V}$	V_{START}		0.8	0.9	V
Hold-on Voltage	$I_{OUT}=1\text{mA}$, $V_{IN}:2 \rightarrow 0\text{V}$	V_{HOLD}			0.7	V
No-Load Input Current	$I_{OUT}=0\text{mA}$	I_{IN}		15		μA
Supply Current	AIC1642-27	I_{DD1}		42		μA
	AIC1642-30			50		
	AIC1642-33			60		
	AIC1642-50			90		
	$V_{IN}=V_{OUT} \times 0.95$ Measurement of the IC input current (VOUT pin)					
Supply Current	$V_{IN}=V_{OUT} + 0.5\text{V}$ Measurement of the IC input current (VOUT pin)	I_{DD2}		8		μA
SW Leakage Current	$V_{SW}=10\text{V}$, $V_{IN}=V_{OUT} + 0.5\text{V}$				0.5	μA
SW Switch-On Resistance	AIC1642-27	R_{ON}		2.2		Ω
	AIC1642-30			2.1		
	AIC1642-33			2.0		
	AIC1642-50			1.9		
	$V_{IN}=V_{SW} \times 0.95$, $V_{SW}=0.4\text{V}$					
Oscillator Duty Cycle	$V_{IN}=V_{OUT} \times 0.95$ Measurement of the SW Pin Waveform	DUTY	65	75	85	%
Max. Oscillator Freq.	$V_{IN}=V_{OUT} \times 0.95$ Measurement of the SW Pin Waveform	F_{OSC}	80	105	130	KHz
Efficiency		η		80		%

TYPICAL PERFORMANCE CHARACTERISTICS

Capacitor (C1) : 47 μ F (Tantalum Type)

Diode (D1) : 1N5819 Schottky Type

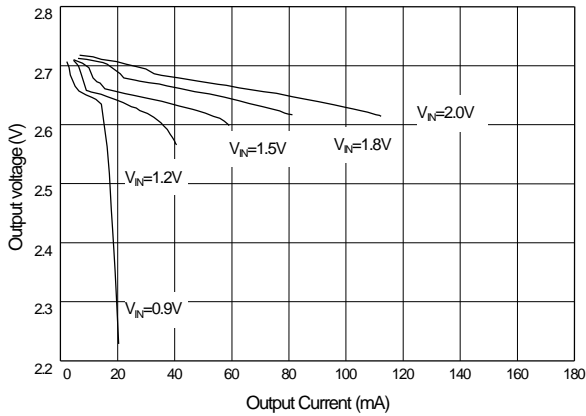

Fig. 1 AIC1642-27 Load Regulation (L=100 μ H CD54)

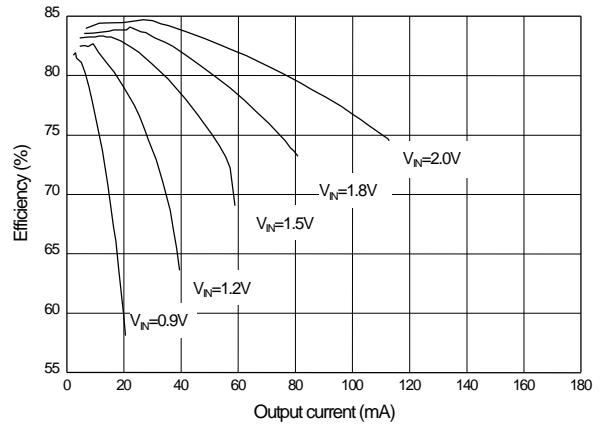

Fig. 2 AIC1642-27 Efficiency (L=100 μ H CD54)

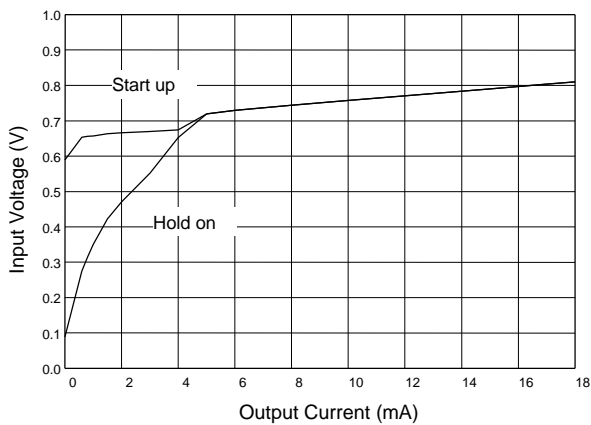

Fig. 3 AIC1642-27 Start-up & Hold-on Voltage (L=100 μ H)

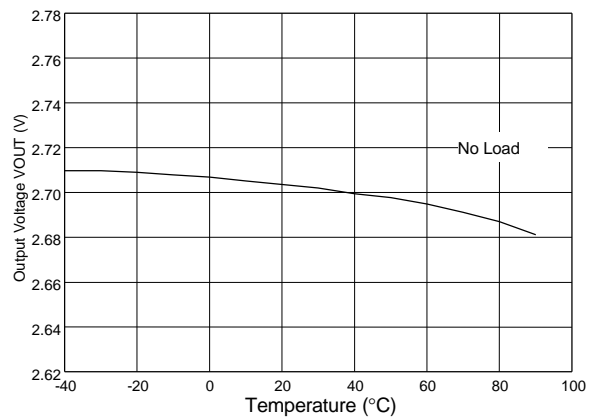

Fig. 4 AIC1642-27 Output Voltage vs. Temperature

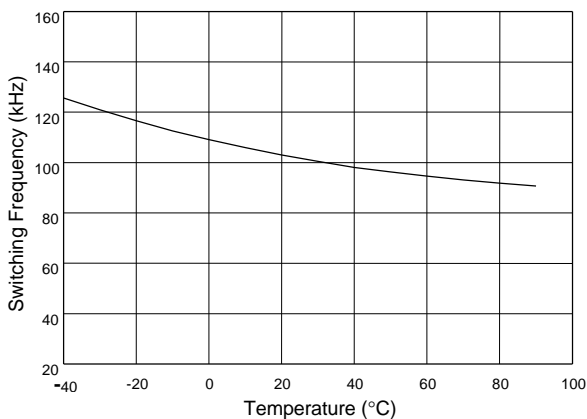

Fig. 5 AIC1642-27 Switching Frequency vs. Temperature

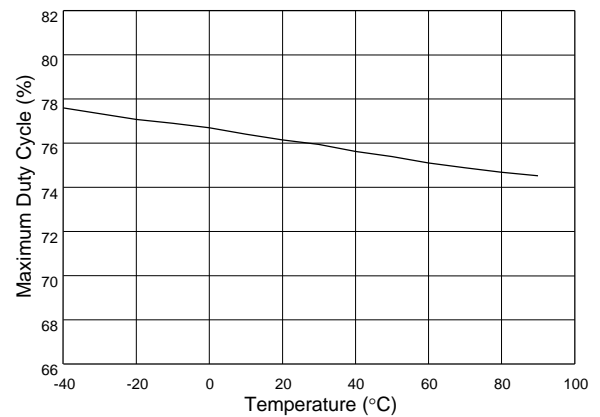

Fig. 6 AIC1642-27 Maximum Duty Cycle vs. Temperature

TYPICAL PERFORMANCE CHARACTERISTICS (Continued)

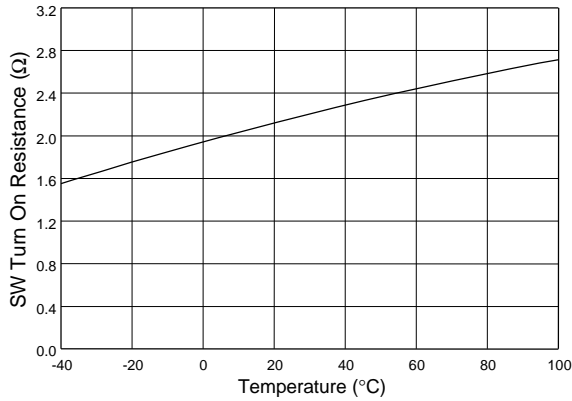

Fig. 7 AIC1642-27 SW On Resistance vs. Temperature

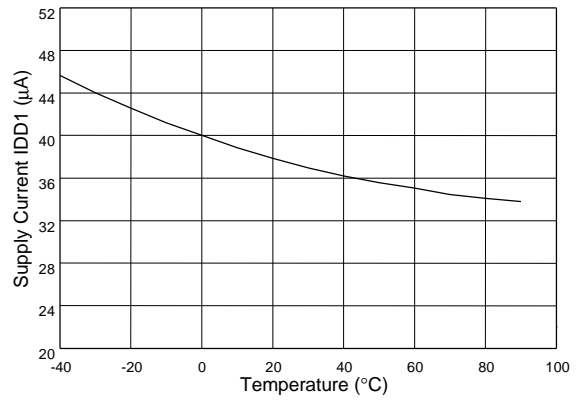

Fig. 8 AIC1642-27 Supply Current IDD1 vs. Temperature

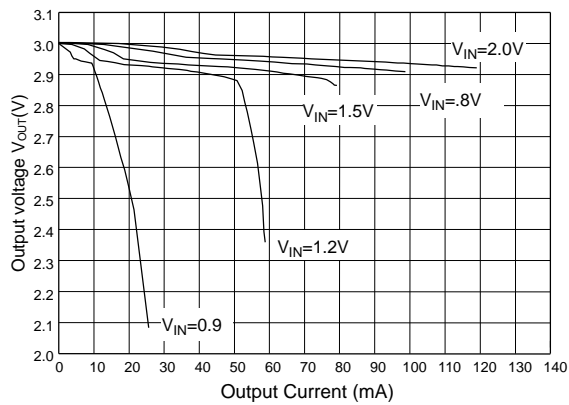

Fig. 9 AIC1642-30 Load Regulation (L=100μH CD54)

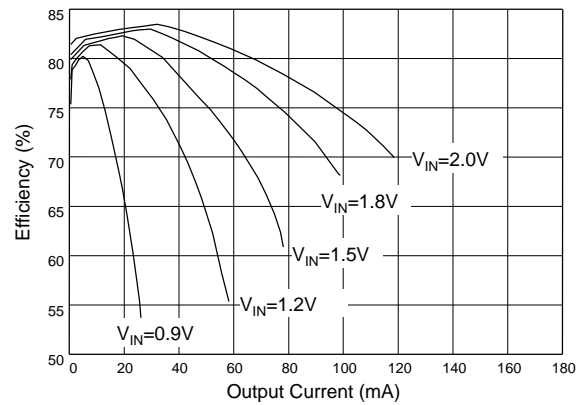

Fig. 10 AIC1642-30 Efficiency (L=100μH CD54)

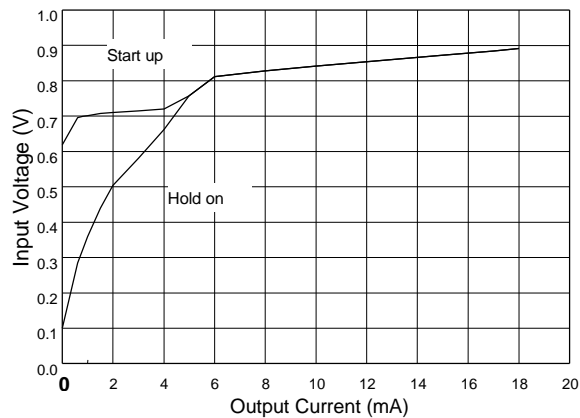

Fig. 11 AIC1642-30 Start-up & Hold-on Voltage (L=100μH)

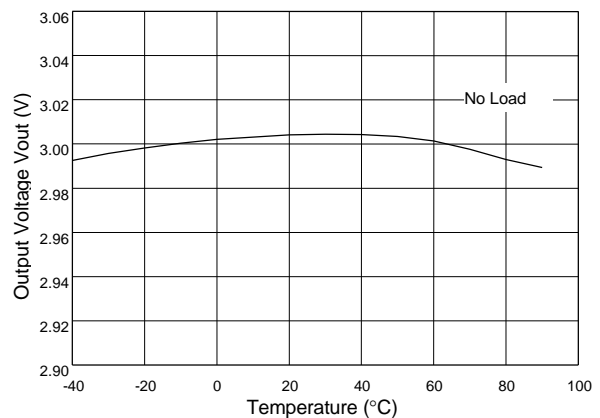

Fig. 12 AIC1642-30 Output Voltage vs. Temperature

TYPICAL PERFORMANCE CHARACTERISTICS (Continued)

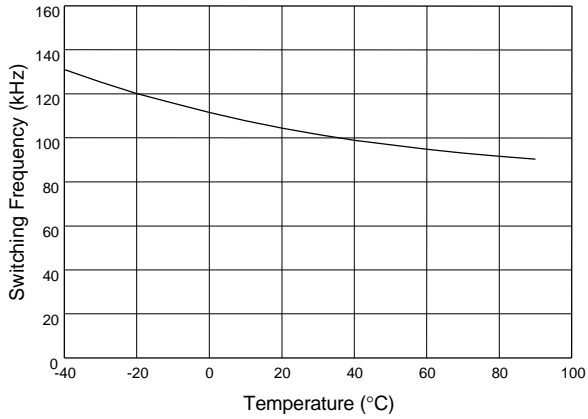

Fig. 13 AIC1642-30 Switching Frequency vs. Temperature

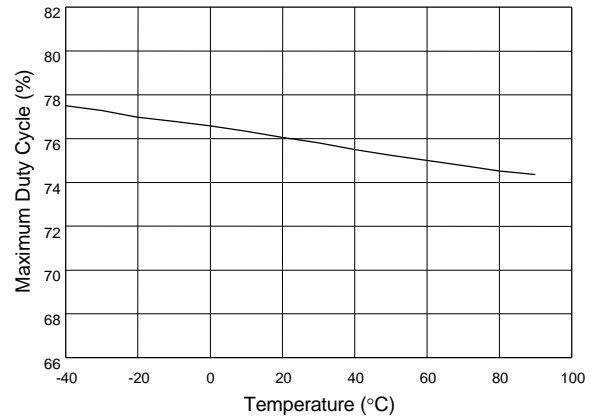

Fig. 14 AIC1642-30 Maximum Duty Cycle vs. Temperature

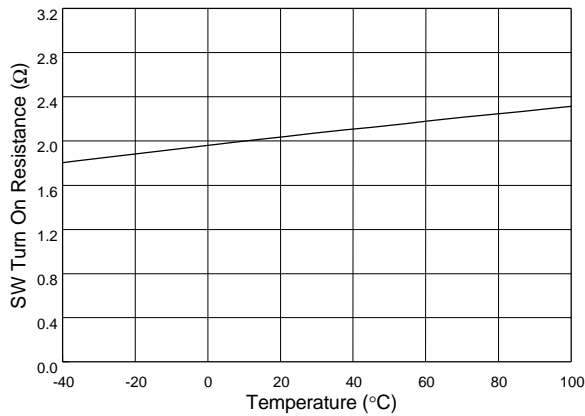

Fig. 15 AIC1642-30 SW On Resistance vs. Temperature

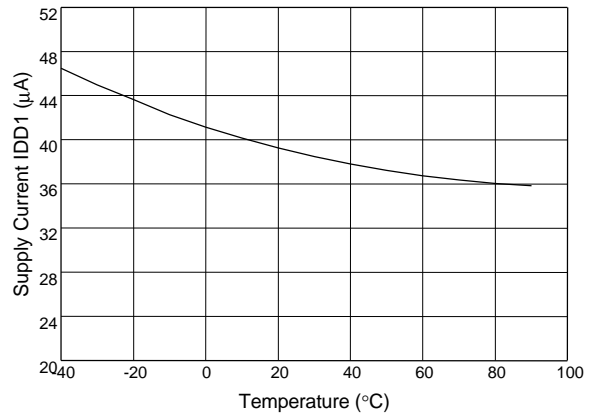

Fig. 16 AIC1642-30 Supply Current vs. Temperature

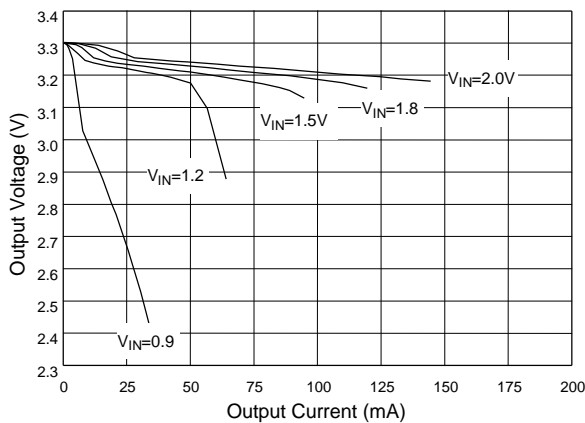

Fig. 17 AIC1642-33 Load Regulation (L=100μH CD54)

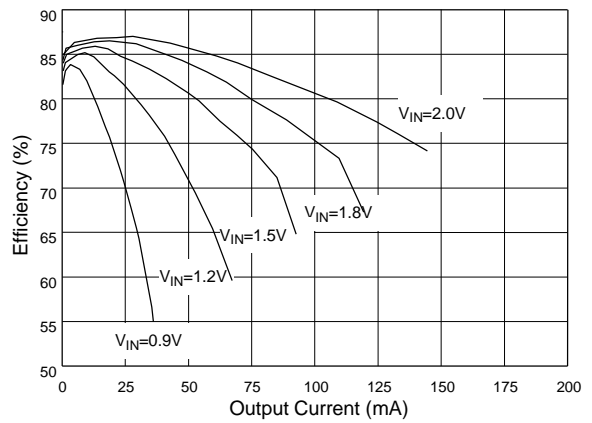

Fig. 18 AIC1642-33 Efficiency (L=100μH CD54)

TYPICAL PERFORMANCE CHARACTERISTICS (Continued)

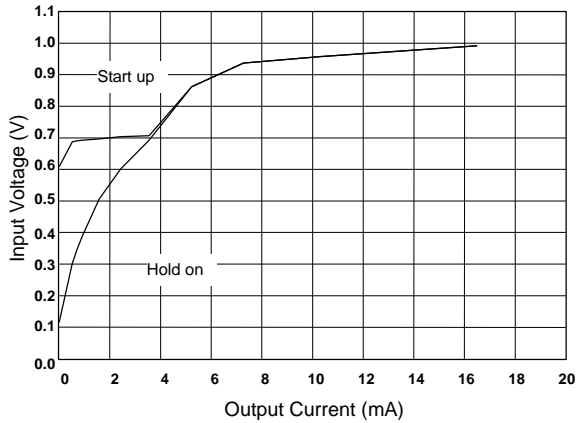

Fig. 19 AIC1642-33 Start-up & Hold-on Voltage (L=100μH)

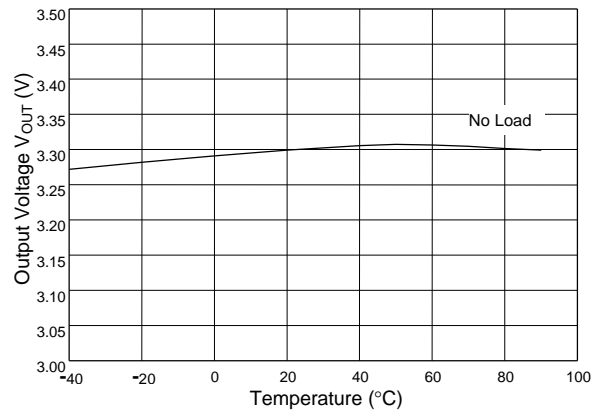

Fig. 20 AIC1642-33 Output Voltage vs. Temperature

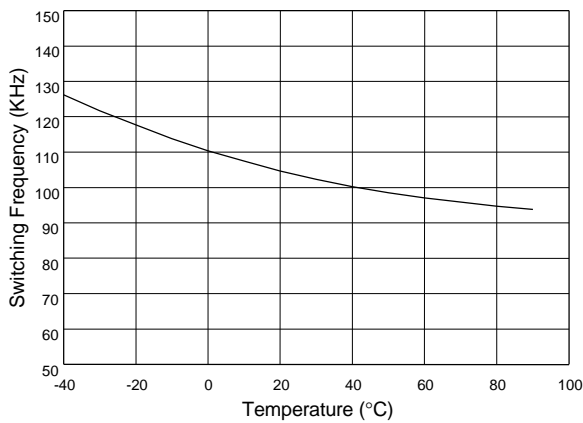

Fig. 21 AIC1642-33 Switching Frequency vs. Temperature

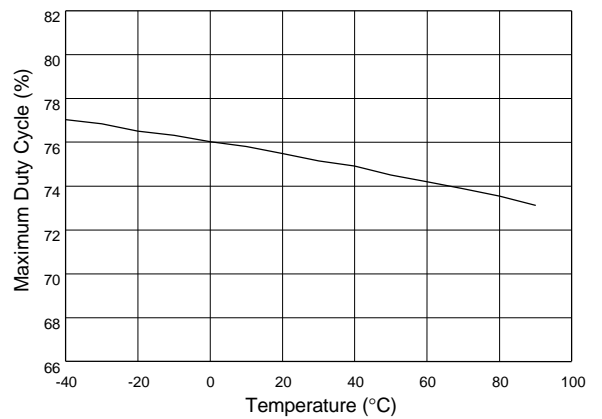

Fig. 22 AIC1642-33 Maximum Duty Cycle vs. Temperature

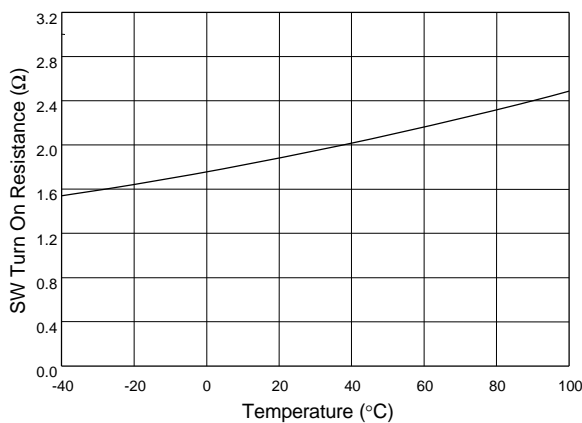

Fig. 23 AIC1642-33 SW On Resistance vs. Temperature

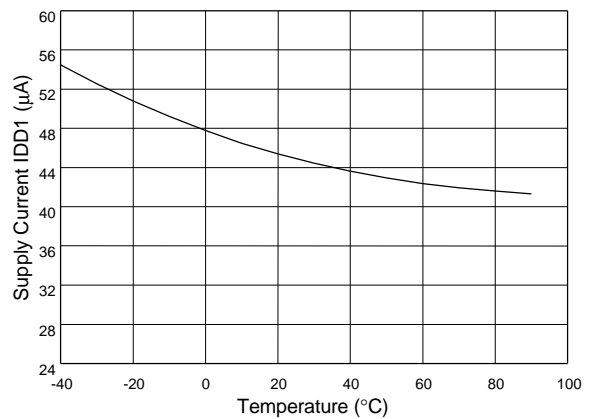

Fig. 24 AIC1642-33 Supply Current vs. Temperature

TYPICAL PERFORMANCE CHARACTERISTICS (Continued)

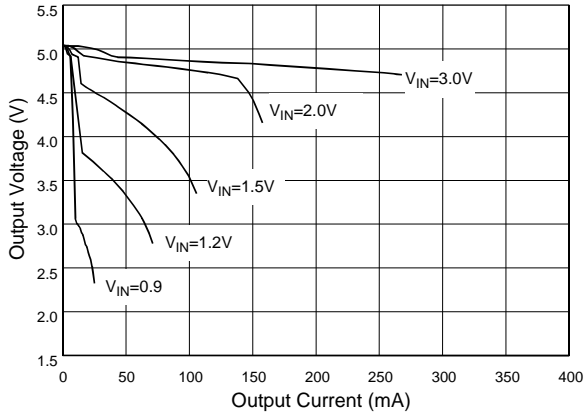

Fig. 25 AIC1642-50 Load Regulation (L=100µH CD54)

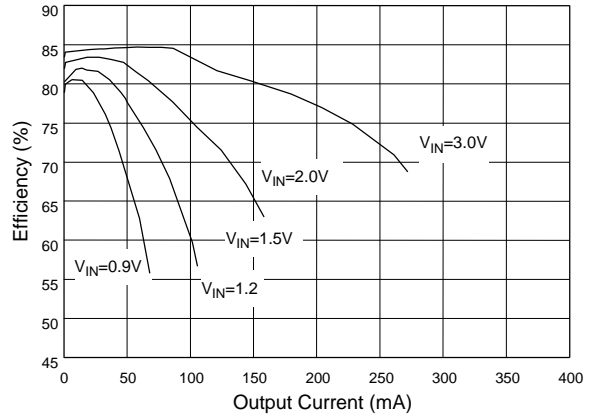

Fig. 26 AIC1642-50 Efficiency (L=100µH, CD54)

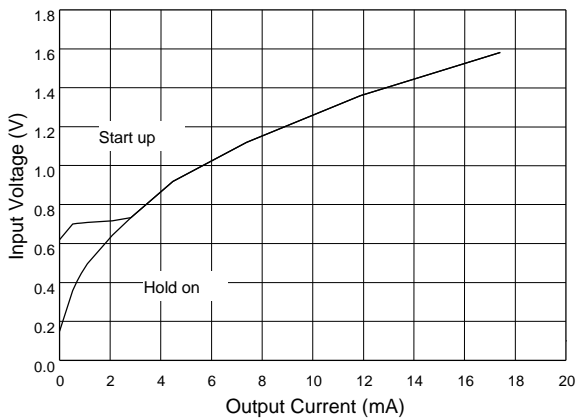

Fig. 27 AIC1642-50 Start-up & Hold-on Voltage (L=100µH)

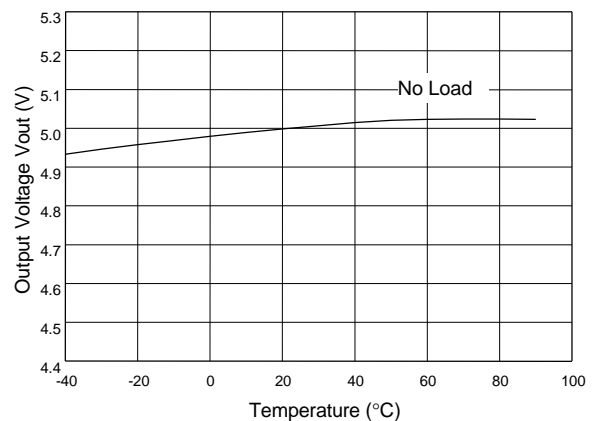

Fig. 28 AIC1642-50 Output Voltage vs. Temperature

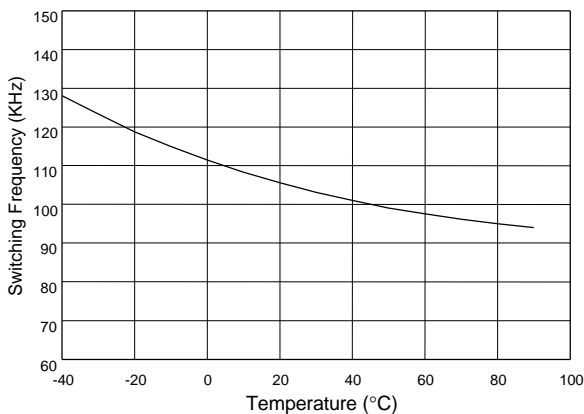

Fig. 29 AIC1642-50 Switching Frequency vs. Temperature

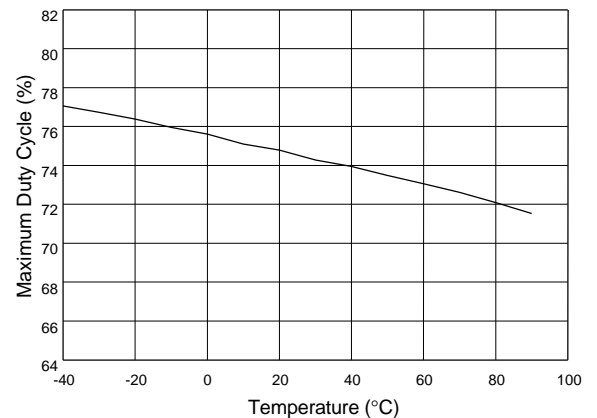

Fig. 30 AIC1642-50 Maximum Duty Cycle vs. Temperature

■ TYPICAL PERFORMANCE CHARACTERISTICS (Continued)

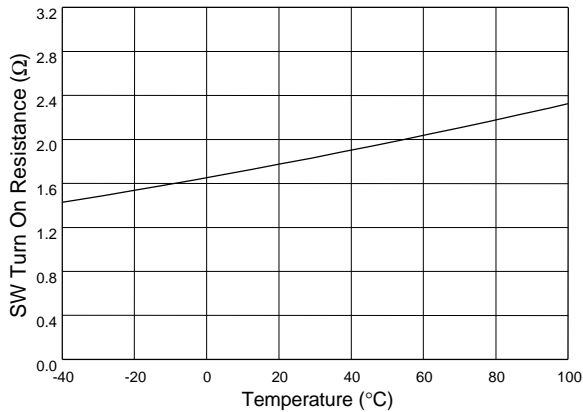

Fig. 31 AIC1642-50 SW On Resistance vs. Temperature

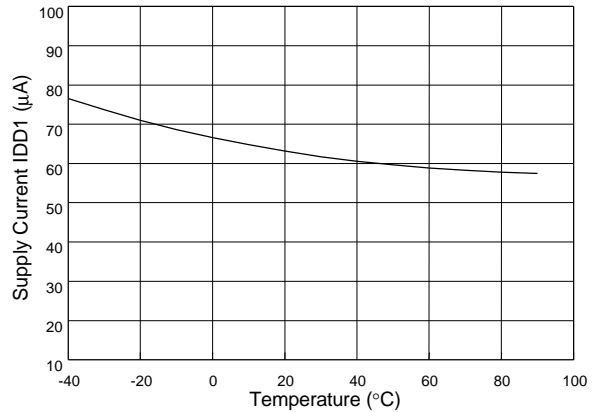
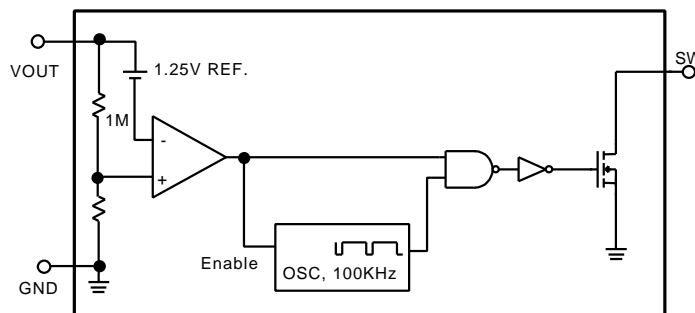

Fig. 34 AIC1642-50 Supply Current vs. Temperature

BLOCK DIAGRAM



PIN DESCRIPTIONS

PIN1 : GND - Ground. Must be low impedance; solder directly to ground plane.

PIN2 : VOUT - IC supply pin. Connect VOUT to the regulator output.

PIN3 : SW – Internal drain of N-MOSFET switch.

APPLICATION INFORMATION

GENERAL DESCRIPTION

AIC1642 PFM (pulse frequency modulation) controller ICs combine a switch mode regulator, N-channel power MOSFET, precision voltage reference, and voltage detector in a single monolithic device. They offer extreme low quiescent current, high efficiency, and very low gate threshold voltage to ensure start-up with low battery voltage (0.8V typ.). Designed to maximize battery life in portable products, and minimize switching losses by only switching as needed service the load.

PFM controllers transfer a discrete amount of energy per cycle and regulate the output voltage by modulating switching frequency with the constant turn-on time. Switching frequency depends on load, input voltage, and inductor value, and it can range up to 100KHz. The SW on-resistance is typically 1.9 to 2.2 Ω to minimize switch losses.

When the output voltage drops, the error comparator enables 100kHz oscillator that turns on the MOSFET around 7.5 μ s and 2.5 μ s off time. Turning on the MOSFET allows inductor current to ramp up, storing energy in a magnetic field. When MOSFET turns off that force inductor current through diode to the output capacitor and load. As the stored energy is depleted, the current ramp down until the diode turns off. At this point, inductor may ring due to residual energy and stray capacitance. The output capacitor stores charge when current flowing through the diode is high, and release it when current is low, thereby maintaining a steady voltage across the load.

As the load increases, the output capacitor discharges faster and the error comparator initiates cycles sooner, increasing the switching frequency. The maximum duty cycle ensure adequate time for energy transfer to output during the second half each cycle. Depending on circuit, PFM controller can operate in either discontinuous mode or con-

tinuous conduction mode. Continuous conduction mode means that the inductor current does not ramp to zero during each cycle.

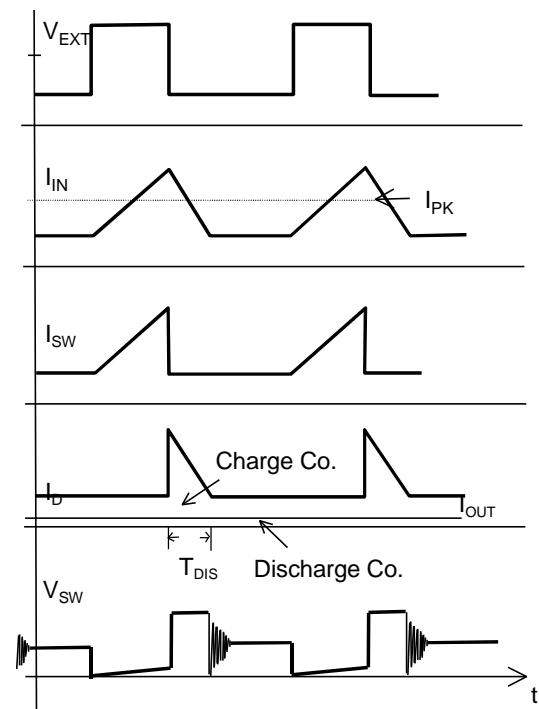
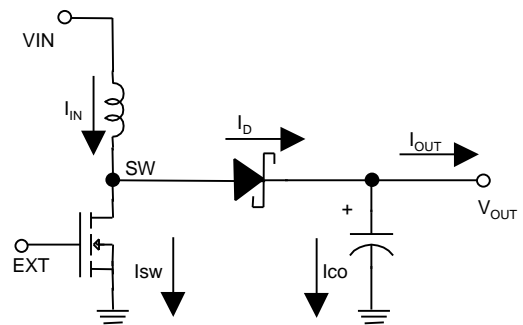

Discontinuous Conduction Mode

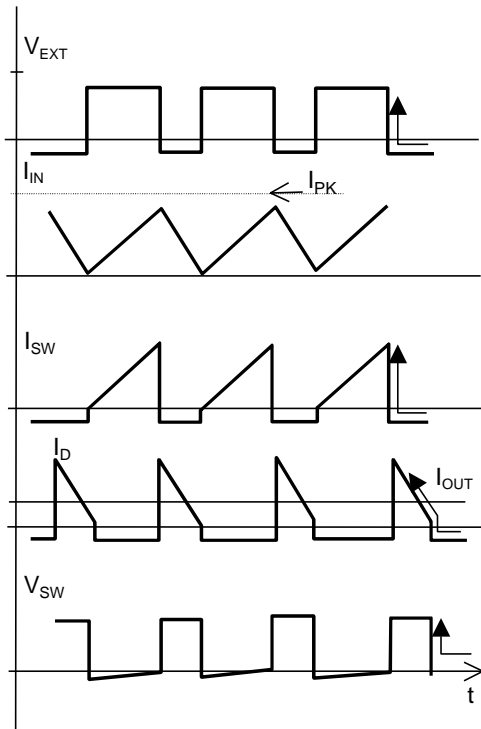

Continuous Conduction Mode

Continuous Conduction Mode

At the boundary between continuous and discontinuous mode, output current (I_{OB}) is determined by

$$I_{OB} = \left(\frac{V_{IN}}{V_{OUT}} \right) * \frac{1}{2} * \frac{V_{IN}}{L} * T_{ON} * (1 - x)$$

where V_d is the diode drop,

$$x = (R_{ON} + R_S) * \frac{T_{ON}}{L}$$

R_{ON} = Switch turn on resistance, R_S = Inductor DC resistance

T_{ON} = Switch ON time

In the discontinuous mode, the switching frequency (F_{sw}) is

$$F_{SW} = \frac{2 * (L) * (V_{OUT} + V_D - V_{IN}) * (I_{OUT})}{V_{IN}^2 * T_{ON}^2} (1 + x)$$

In the continuous mode, the switching frequency is

$$f_{sw} = \frac{1}{T_{ON}} \frac{(V_{OUT} + V_D - V_{IN})}{(V_{OUT} + V_D - V_{SW})} * \left[1 + \frac{x}{2} \left(\frac{V_{IN} - V_{SW}}{V_{OUT} + V_D - V_{SW}} \right) \right] \cong \frac{1}{T_{ON}} \left(\frac{V_{OUT} + V_D - V_{IN}}{V_{OUT} + V_D - V_{SW}} \right)$$

where V_{sw} = switch drop and proportion to output current.

Inductor Selection

To operate as an efficient energy transfer element, the inductor must fulfill three requirements. First, the inductance must be low enough for the inductor to store adequate energy under the worst case condition of minimum input voltage and switch ON time. Second, the inductance must also be high enough so maximum current rating of AIC1642 and inductor are not exceeded at the other worst case condition of maximum input voltage and ON time. Lastly, the inductor must have sufficiently low DC resistance so excessive power is not lost as heat in the windings. But unfortunately this is inversely related to physical size.

Minimum and maximum input voltage, output voltage and output current must be established in advance and then inductor can be selected.

In discontinuous mode operation, at the end of the switch ON time, peak current and energy in the inductor build according to

$$I_{PK} = \left(\frac{V_{IN}}{R_{ON} + R_S} \right) * \left(1 - \exp\left(-\frac{R_{ON} + R_S}{L} * T_{ON}\right) \right) \cong \left(\frac{V_{IN}}{L} \right) * (T_{ON}) * \left(1 - \frac{x}{2} \right) \cong \frac{V_{IN}}{L} T_{ON} \quad (\text{simple loss equation}),$$

where $x = (R_{ON} + R_S) * \frac{T_{ON}}{L}$

$$E_L = \frac{1}{2} L \times I_{pk}^2$$

Power required from the inductor per cycle must be equal or greater than

$$P_L/f_{sw} = (V_{OUT} + V_D - V_{IN}) * (I_{OUT}) * \left(\frac{1}{f_{sw}}\right)$$

In order for the converter to regulate the output.

When loading is over IOB, PFM controller operates in continuous mode. Inductor peak current can be derived from

$$I_{PK} = \left(\frac{V_{OUT} + V_D - V_{SW} - \frac{X}{2}}{V_{IN} - V_{SW}}\right) * I_{OUT} + \left(\frac{V_{IN} - V_{SW}}{2L}\right) * T_{ON} * \left(1 - \frac{X}{2}\right)$$

Valley current (I_v) is

$$I_V = \left(\frac{V_{OUT} + V_D - V_{SW} - \frac{X}{2}}{V_{IN} - V_{SW}}\right) * I_{OUT} - \left(\frac{V_{IN} - V_{SW}}{2L}\right) * T_{ON} * \left(1 - \frac{X}{2}\right)$$

Table 1 Indicates resistance and height for each coil.

Power Inductor Type		Inductance (mH)	Resistance (W)	Rated Current (A)	Height (mm)
Coilcraft SMT Type (www.coilcraft.com)	DS1608	22	0.10	0.7	2.9
		47	0.18	0.5	
		100	0.38	0.3	
	DO3316	22	0.08	2.7	5.2
47		0.14	1.8		
Sumida SMT Type CD54		47	0.25	0.7	4.5
		100	0.50	0.5	
Hold SMT Type PM54		47	0.25	0.7	4.5
		100	0.50	0.5	
Hold SMT Type PM75		33	0.11	1.2	5.0

Capacitor Selection

A poor choice for an output capacitor can result in poor efficiency and high output ripple. Ordinary aluminum electrolytic, while inexpensive may have unacceptably poor ESR and ESL. There are low ESR aluminum capacitors for switch mode DC-DC converters which work much well than general unit. Tantalum capacitors provide still better performance at more expensive. OS-CON capacitors have extremely low ESR in a small size. If capacitance is reduced, output ripple will increase.

Most of the input supply is supplied by the input bypass capacitor, the capacitor voltage rating should be at least 1.25 times greater than a maximum input voltage.

Diode Selection

Speed, forward drop, and leakage current are the three main considerations in selecting a rectifier diode. Best performance is obtained with Schottky rectifier diode such 1N5819. Motorola makes MBR0530 in surface mount. For lower output power a 1N4148 can be used although efficiency and start-up voltage will suffer substantially.

Component Power Dissipation

Operating in discontinuous mode, power loss in the winding resistance of inductor can be approximate equal to

$$PD_L = \frac{2}{3} \left(\frac{T_{ON}}{L} \right) * (R_D) * \left(\frac{V_{OUT} + V_F}{V_{OUT}} \right) * (P_{OUT})$$

where $P_{OUT} = V_{OUT} * I_{OUT}$; $R_S =$ Inductor DC R;

$V_D =$ Diode drop.

The power dissipated in a switch loss is

$$PD_{SW} = \frac{2}{3} \left(\frac{T_{ON}}{L} \right) * (R_{ON}) * \left(\frac{V_{OUT} + V_D - V_{IN}}{V_{OUT}} \right) * (P_{OUT})$$

The power dissipated in rectifier diode is

$$PD_d = \left(\frac{V_D}{V_{OUT}} \right) * (P_{OUT})$$

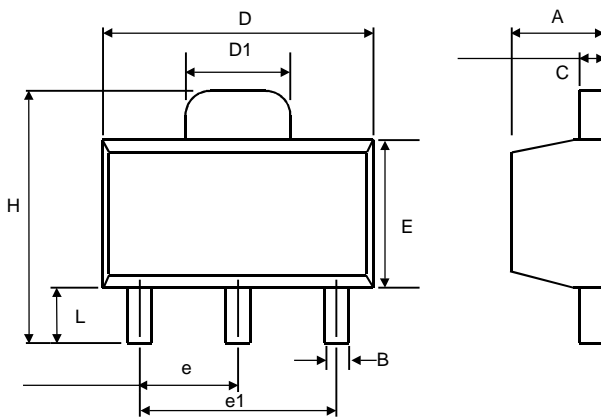
PHYSICAL DIMENSIONS
● SOT-89 (unit: mm)

SYMBOL	MIN	MAX
A	1.40	1.60
B	0.36	0.48
C	0.35	0.44
D	4.40	4.60
D1	1.62	1.83
E	2.29	2.60
e	1.50 (TYP.)	
e1	3.00 (TYP.)	
H	3.94	4.25
L	0.89	1.20

● SOT-89 MARKING

Part No.	Marking
AIC1642-27	AM27
AIC1642-30	AM30
AIC1642-33	AM33
AIC1642-50	AM50

- TO-92 (unit: mm)

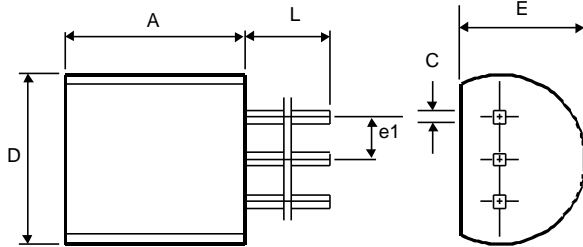

SYMBOL	MIN	MAX
A	4.32	5.33
C	0.38 (TYP.)	
D	4.40	5.20
E	3.17	4.20
e1	1.27 (TYP.)	