

SPECIFICATION FOR APPROVAL

REF : 20071102-D

PAGE: 1

PROD. NAME	WOUND CHIP INDUCTOR	ABC'S DWG NO. ABC'S ITEM NO.	CC4532□□□□L□-□□□
---------------	---------------------	---------------------------------	------------------

I . CONFIGURATION & DIMENSIONS :

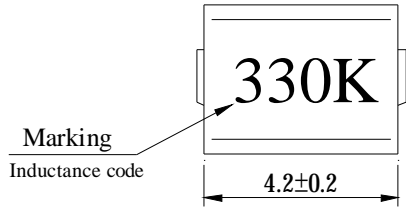

- A : 4.5±0.3 m/m
- B : 3.2±0.2 m/m
- C : 3.2±0.2 m/m
- E : 1.2 m/m
- F : 1.0^{+0.3}₋₀ m/m

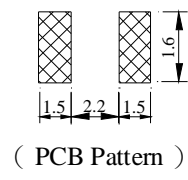
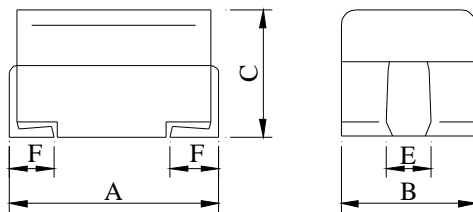

II . SCHEMATIC DIAGRAM :

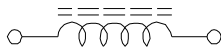

III . MATERIALS :

- a . Core : Ferrite DR core
- b . Wire : Enamelled copper wire (class H)
- c . Terminal : Cu/Sn
- d . Encapsulate : Epoxy novolac molding compound
- e . Remark : Products comply with RoHS' requirements

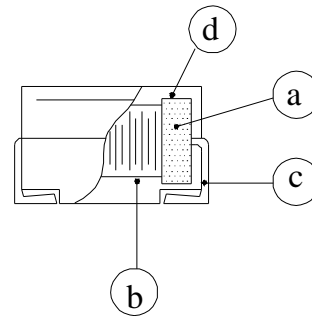

IV . GENERAL SPECIFICATION :

- a . Temp. rise : 20°C max.
- b . Ambient temp. : 100°C max.
- c . Storage temp. : -40°C ----+125°C
- d . Operating temp. : -40°C ----+125°C
- e . Terminal pull strength : 1.5 kg min.
- f . Rated current : Current cause
inductance drop within 10%
- g . Resistance to solder heat : 260°C.10 secs.
- h . Resistance to solvent : Per MIL-STD-202F

Reflow profile
 Peak Temp : 250°C max.
 Max time above 245°C : 20-40sec max.
 Max time above 217°C : 60-150sec max.
 200°C-250°C Average Ramp-up Rate : 3°C/second max.

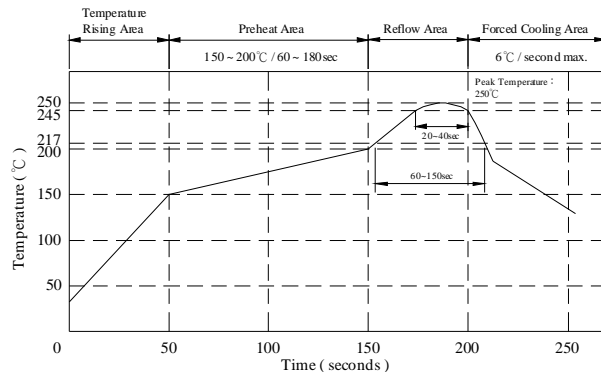

AR-001A

SPECIFICATION FOR APPROVAL

REF : 20071102-D

PAGE: 2

PROD. NAME	WOUND CHIP INDUCTOR	ABC'S DWG NO.	CC4532□□□□L□-□□□
		ABC'S ITEM NO.	

V . ELECTRICAL CHARACTERISTICS :

DWG NO.	Inductance (μH)	Q min.	Test Freq. (MHz)	SRF (MHz) min.	RDC (Ω) max.	IDC (mA) max.
CC45321R0KL□ -□□□	1.00 ±10%	10	7.96	180.0	0.11	1050
CC45321R2KL□ -□□□	1.20 ±10%	10	7.96	160.0	0.12	1000
CC45321R5KL□ -□□□	1.50 ±10%	10	7.96	130.0	0.15	950
CC45321R8KL□ -□□□	1.80 ±10%	10	7.96	100.0	0.16	900
CC45322R2KL□ -□□□	2.20 ±10%	10	7.96	80.0	0.18	850
CC45322R7KL□ -□□□	2.70 ±10%	10	7.96	60.0	0.20	800
CC45323R3KL□ -□□□	3.30 ±10%	10	7.96	45.0	0.22	750
CC45323R9KL□ -□□□	3.90 ±10%	10	7.96	40.0	0.24	700
CC45324R7KL□ -□□□	4.70 ±10%	10	7.96	35.0	0.27	650
CC45325R6KL□ -□□□	5.60 ±10%	10	7.96	30.0	0.30	650
CC45326R8KL□ -□□□	6.80 ±10%	10	7.96	28.0	0.35	600
CC45328R2KL□ -□□□	8.20 ±10%	10	7.96	25.0	0.40	600
CC4532100KL□ -□□□	10.00 ±10%	10	2.52	22.0	0.50	550
CC4532120KL□ -□□□	12.00 ±10%	10	2.52	21.0	0.60	500
CC4532150KL□ -□□□	15.00 ±10%	10	2.52	20.0	0.70	450
CC4532180KL□ -□□□	18.00 ±10%	10	2.52	19.0	0.80	400
CC4532220KL□ -□□□	22.00 ±10%	10	2.52	18.0	0.90	370
CC4532270KL□ -□□□	27.00 ±10%	10	2.52	16.0	1.20	330
CC4532330KL□ -□□□	33.00 ±10%	10	2.52	14.0	1.40	300
CC4532390KL□ -□□□	39.00 ±10%	10	2.52	12.0	1.60	280
CC4532470KL□ -□□□	47.00 ±10%	10	2.52	11.5	1.90	260
CC4532560KL□ -□□□	56.00 ±10%	10	2.52	11.0	2.20	240
CC4532680KL□ -□□□	68.00 ±10%	10	2.52	10.0	2.60	220
CC4532820KL□ -□□□	82.00 ±10%	10	2.52	9.0	3.50	200
CC4532101KL□ -□□□	100.00 ±10%	20	0.796	8.0	4.00	180
CC4532121KL□ -□□□	120.00 ±10%	20	0.796	7.5	4.50	160
CC4532151KL□ -□□□	150.00 ±10%	20	0.796	7.0	6.50	140
CC4532181KL□ -□□□	180.00 ±10%	20	0.796	6.5	7.50	120
CC4532221KL□ -□□□	220.00 ±10%	20	0.796	5.5	9.00	120
CC4532271KL□ -□□□	270.00 ±10%	20	0.796	5.0	11.00	100
CC4532331KL□ -□□□	330.00 ±10%	20	0.796	4.0	13.00	90
CC4532391KL□ -□□□	390.00 ±10%	20	0.796	3.0	14.00	85
CC4532471KL□ -□□□	470.00 ±10%	20	0.796	3.0	16.00	75
CC4532561KL□ -□□□	560.00 ±10%	20	0.796	3.0	18.00	70
CC4532681KL□ -□□□	680.00 ±10%	20	0.796	2.5	22.80	65

1). □ : Packaging information... A : Bulk B : Taping Reel

2). "- □□□ " : Reference code

AR-001A



SPECIFICATION FOR APPROVAL

REF : 20071102-D

PAGE: 3

PROD. NAME	WOUND CHIP INDUCTOR	ABC'S DWG NO. ABC'S ITEM NO.	CC4532□□□□L□-□□□
---------------	---------------------	---------------------------------	------------------

VI . CURVE :

@ Inductance VS. DC Superposition Characteristics

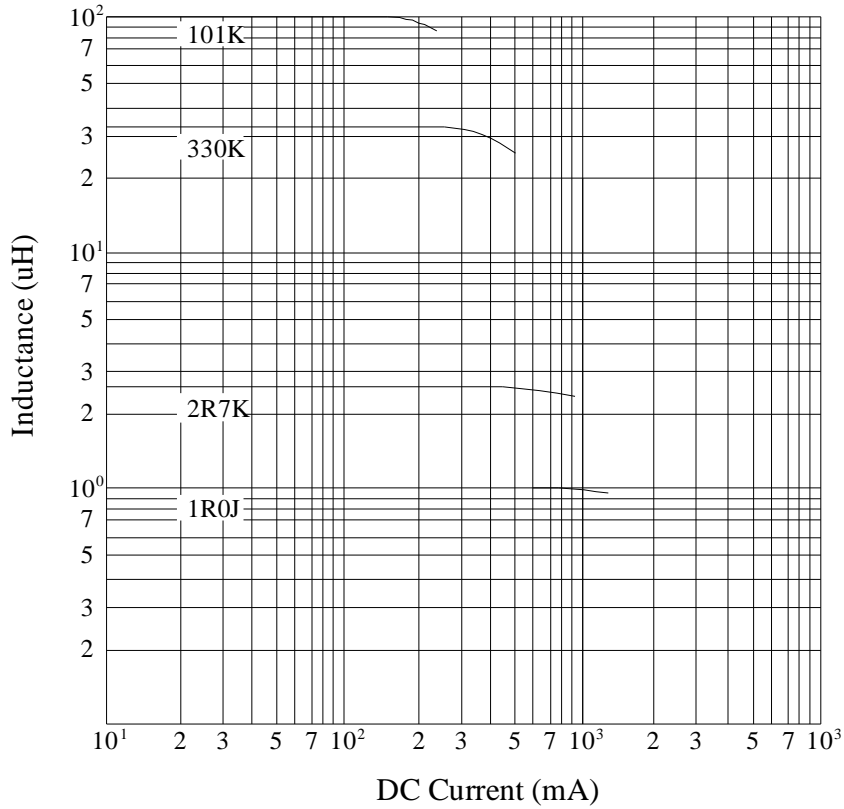

@ Q VS. Frequency Response

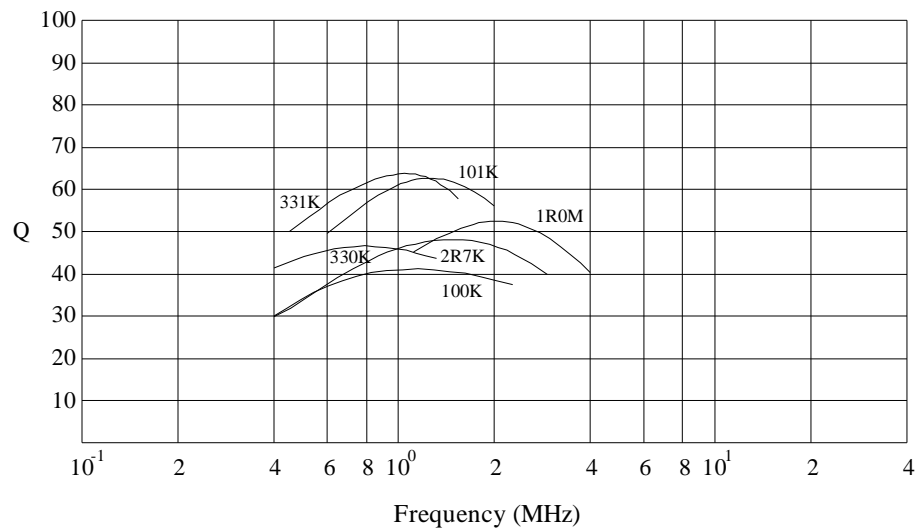

AR-001A



SPECIFICATION FOR APPROVAL

REF : 20071102-D

PAGE: 4

PROD. NAME	WOUND CHIP INDUCTOR	ABC'S DWG NO.	CC4532□□□□L□-□□□
		ABC'S ITEM NO.	

VII . PACKAGING INFORMATION :

(1) Configuration

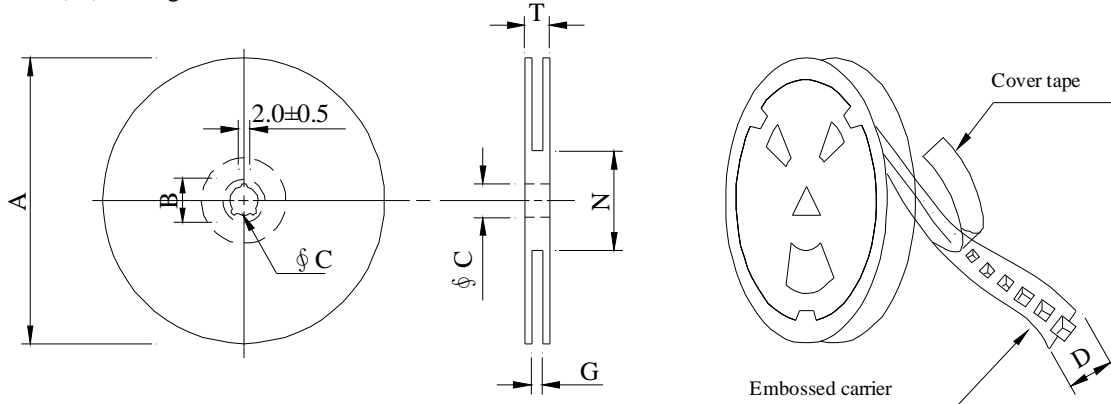

※Carrier tape width : D

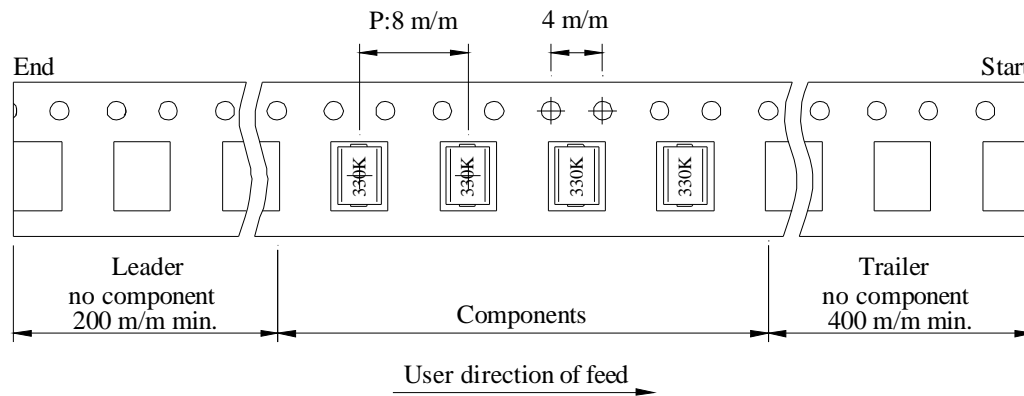

※ There is no differentiation or directions of polarity (marking) in the packaging method.

(2) Dimensions

Unit:m/m

Style	A	B	C	D	G	N	T
07 - 12	178	21±0.8	13	12	14 ⁺⁰	50 ⁻⁰	16.5
13 - 12	330	21±0.8	13±0.5	12	14 ⁺⁰	50 ⁻⁰	18.4

(3) Q'TY & G.W. Per package

Series	Inner : Reel			Outer : Carton		
	Q'TY (pcs)	G.W. (gw)	Style	Q'TY (pcs)	G.W. (Kg)	Size (cm)
CC4532	500	140	07 - 12	20,000	8.00	41 x 39 x 22
CC4532	2000	550	13 - 12	18,000	6.80	41 x 39 x 22

AR-001A

SPECIFICATION FOR APPROVAL

REF : 20071102-D

PAGE: 6

PROD. NAME	WOUND CHIP INDUCTOR	ABC'S DWG NO. ABC'S ITEM NO.	CC4532□□□□L□-□□□
IX . RELIABILITY TEST :			
Test item	Specification	Test condition / Test method	
● Electrical performance test			
Inductance L	Refer to standard electrical characteristic list	□HP4194A with HP-16034E test fixture	
Q			
Self resonance frequency SRF		□HP4291A with HP-16093A test fixture	
DC Resistance RDC		CH-502AC	
Rated current IDC		Applied the current to coils , The Inductance change shall be less than 10% to initial value & temperature rise shall not be more than 20°C	
Temperature rise test	20°C max.	1 . Applied the allowed DC current for 10 minutes 2 . Temperature measure by digital surface thermometer	
Over load test	After test , Inductors shall be no evidence of electrical and mechanical damage	Applied 2 times of rated allowed DC current to inductor for a period of 5 minutes	
Withstanding voltage test	After tset , Inductors shall be no evidence of electrical and mechanical damage	AC voltage of 1000VAC applied between inductors terminal and coating for 5 seconds	
Insulation resistance test	1000 MΩ min .	100 VDC applied between inductor terminal and coating	
● Mechanical performance test			
Vibration test (Low frequency)	1 . Inductors shall be no evidence of electrical and mechanical damage	1 . Amplitude : 1.5 m/m 2 . Frequency : 10 -- 55 -- 10 Hz / 1min. 3 . Direction : X , Y , Z 4 . Duration : 2 hrs / X , Y , Z	
Shock test	2 . Inductance shall not change more than±5%	Inductors shall be dropped 10 times from a height of 1m onto 3cm wooden board	
Resistance to soldering heat	3 . Q Shall not change more than ±20%	Temp : 260±5°C Time : 10±1.0 sec.	

AR-001A



千如電子集團
ABC ELECTRONICS GROUP.

SPECIFICATION FOR APPROVAL

REF : 20071102-D

PAGE: 8

PROD. NAME	WOUND CHIP INDUCTOR	ABC'S DWG NO.	CC4532□□□□L□-□□□
		ABC'S ITEM NO.	

X . UL CARD :

OBMW2	August 27, 1999		
Magnet Wire-Component			
ELEKTRISOLA (MALAYSIA) SDN BHD		E143312	
IALAN DAMN SATU IANDA BAIK 28750 BENTONG, PAHANG			
DARUL MAKMUR MALAYSIA			

Mtl Dsg	Mark Dsg	Coating Type		ANSI Typ	Temp Class
		BC	OC		
Estersol 160	E180	Polyesterimide (solderable)	—	MW-77	180
Amldester 200	A200	Polyesterimide	—	MW-74	200
Polysol-N 155	PN155	Polyurechane	Nylon	MW-80,	155,
				MW-28	100
Polysol 155	P155	Polyurechane	—	MW-79,	155,
				MW-79	130
Polysol 155g	Pg155	Polyurechane	—	MW-79	130
Polysol 155p	Pp155,Gp155	Polyurechane	—	MW-79	155
Polysol 160	P160	Polyurechane	—	MW-79	155
Polysol 180	P180	Polyurechane	—	MW-79	155
Polysol 170	P170 or G170	Polyurechane	—	MW-79	156
Polysol-N 180	PN180	Polyurechane	Nylon	—	180

Marking : Company name/material designation or marked designation and factory identification on package ok reel

See General Information preceding These Recognitions
For use only in equipment where the acceptability of the combination is determined by Underwriters Laboratories Inc.

OMFZ2	March 4, 1994		
Component-Plastics			
CHANG CHUN PLASTICS CO LTD		E59481 (S)	
		(F1-cont. from F card)	

BM-21	ALL	0.79	94HB	50	50	50	—	—	—	—	—
BM-22	ALL	0.79	94HB	50	50	50	—	—	—	—	—
BM-23	ALL	0.79	94V-0	50	50	50	—	—	—	—	—
EME-1100	BK	0.84	94V-0	130	130	130	—	—	—	—	—
	BK	6.4	94V-0	130	130	130	—	—	—	—	—
EME-1200	BK	0.84	94V-0	130	130	130	—	—	—	—	—
	BK	6.4	94V-0	130	130	130	—	—	—	—	—
EME-5961C	BK	0.3	94V-0	130	130	130	—	—	—	—	—
	BK	3.1	94V-0	130	130	130	—	—	—	—	—

Reports: January 19, 1988: January 19, 1988: January 19, 1988: June 2, 1988;
June 2, 1998; June 2, 1988.

Replaces E59481C dated February 7, 1989. (Cont. on C1 card)
262854001 N7047 Underwriters Laboratories Inc.® D11/0018965

AR-001A

