

SPECIFICATION FOR APPROVAL

REF : 20090506-B

PAGE: 1

PROD. NAME	SHIELDED SMD POWER INDUCTOR	ABC'S DWG NO.	SH4018□□□□L□-□□□
		ABC'S ITEM NO.	

I . CONFIGURATION & DIMENSIONS :

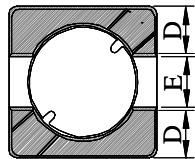
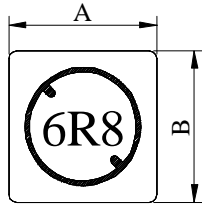

- A : 4.80±0.2 m/m
- B : 4.80±0.2 m/m
- C : 1.80±0.2 m/m
- D : 1.60 typ. m/m
- E : 1.60 typ. m/m
- G : 1.50 ref. m/m
- H : 5.30 ref. m/m
- I : 2.00 ref. m/m
- R : 1.80 ref. m/m

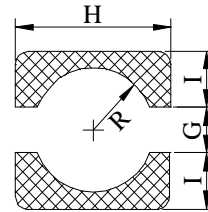

(PCB Pattern suggestion)

II . SCHEMATIC DIAGRAM :

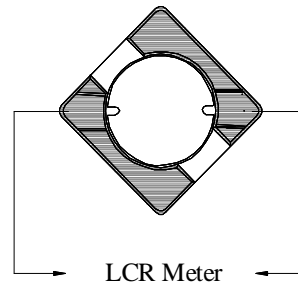

III . MATERIALS :

- a . Core : Ferrite DR core
- b . Core : Ferrite RI core
- c . Wire : Enamelled copper wire (Class F & H)
- d . Adhesive : Epoxy resin
- e . Terminal : Ag/Ni/Sn
- f . Remark : Products comply with RoHS' requirements

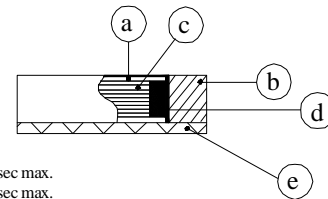

Peak Temp : 260°C max.
 Max time above 230°C : 50sec max.
 Max time above 200°C : 70sec max.

IV . GENERAL SPECIFICATION :

- a . Temp. rise : 30°C max.
- b . Storage temp. : -40°C ----+125°C
- c . Operating temp. : -40°C ----+105°C
- d . Resistance to solder heat : 260°C.10 secs.

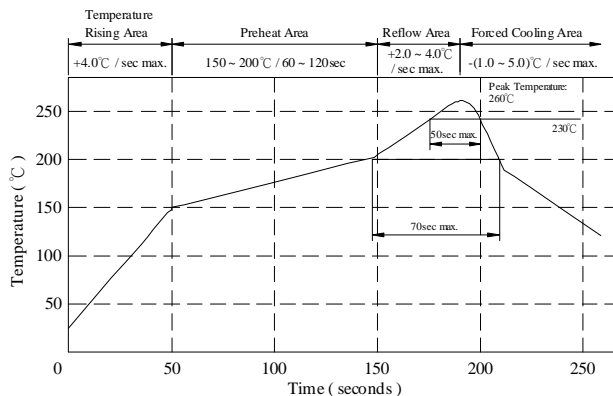

AR-001A

SPECIFICATION FOR APPROVAL

REF : 20090506-B

PAGE: 2

PROD. NAME	SHIELDED SMD POWER INDUCTOR	ABC'S DWG NO.	SH4018□□□□L□-□□□
		ABC'S ITEM NO.	

V . ELECTRICAL CHARACTERISTICS :

DWG No.	Inductance (μ H)	SRF (MHz) typ.	RDC (m Ω)		I _{rms} (mA) max.	I _{sat} (mA) typ.
			typ.	max.		
SH40181R0YL□-□□□	1.0 ±30%	219	25	35	2700	2600
SH40181R8YL□-□□□	1.8 ±30%	105	43	58	2350	2200
SH40182R7YL□-□□□	2.7 ±30%	78	45	60	2030	1950
SH40183R3YL□-□□□	3.3 ±30%	61	49	65	1950	1800
SH40183R9YL□-□□□	3.9 ±30%	60	55	75	1820	1650
SH40184R7YL□-□□□	4.7 ±30%	55	62	82	1720	1500
SH40185R6YL□-□□□	5.6 ±30%	57	70	90	1640	1250
SH40186R8YL□-□□□	6.8 ±30%	49	78	100	1500	1150
SH40188R2YL□-□□□	8.2 ±30%	40	102	135	1400	1100
SH4018100YL□-□□□	10.0 ±30%	38	114	150	1300	1000
SH4018120YL□-□□□	12.0 ±30%	32	130	170	1150	900
SH4018150YL□-□□□	15.0 ±30%	30	174	220	1030	820
SH4018180YL□-□□□	18.0 ±30%	30	224	280	920	750
SH4018220YL□-□□□	22.0 ±30%	29	240	300	880	650
SH4018270YL□-□□□	27.0 ±30%	23	286	370	770	600
SH4018330YL□-□□□	33.0 ±30%	21	324	420	730	500
SH4018390YL□-□□□	39.0 ±30%	19	420	540	640	480
SH4018470YL□-□□□	47.0 ±30%	20	450	600	620	450
SH4018560YL□-□□□	56.0 ±30%	15	643	820	520	400
SH4018680YL□-□□□	68.0 ±30%	13	670	860	500	380
SH4018820YL□-□□□	82.0 ±30%	13	935	1200	430	320
SH4018101YL□-□□□	100.0 ±30%	12	1050	1350	400	300

- 1). □ : Packaging Information... [A]: Bulk [B]: Taping Reel
- 2). "-□□□":Reference code
- 3). Inductance Test Freq. : 100KHz /0.1V
- 4). I_{rms} base on Temp. rise 30°C max.
- 5). I_{sat} base on $\Delta L/L0A=35\%$ typ.

@ Inductance VS. DC Current Curve

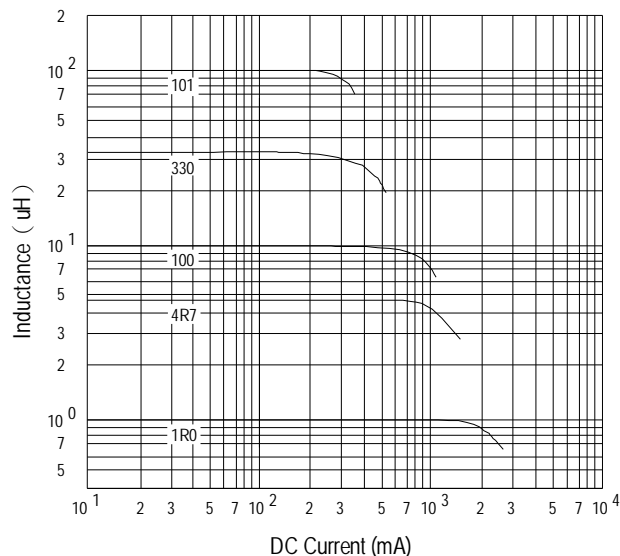

AR-001A

SPECIFICATION FOR APPROVAL

REF : 20090506-B

PAGE: 3

PROD. NAME	SHIELDED SMD POWER INDUCTOR	ABC'S DWG NO.	SH4018□□□□L□-□□□
		ABC'S ITEM NO.	

VI . PACKAGING INFORMATION :

(1) Configuration

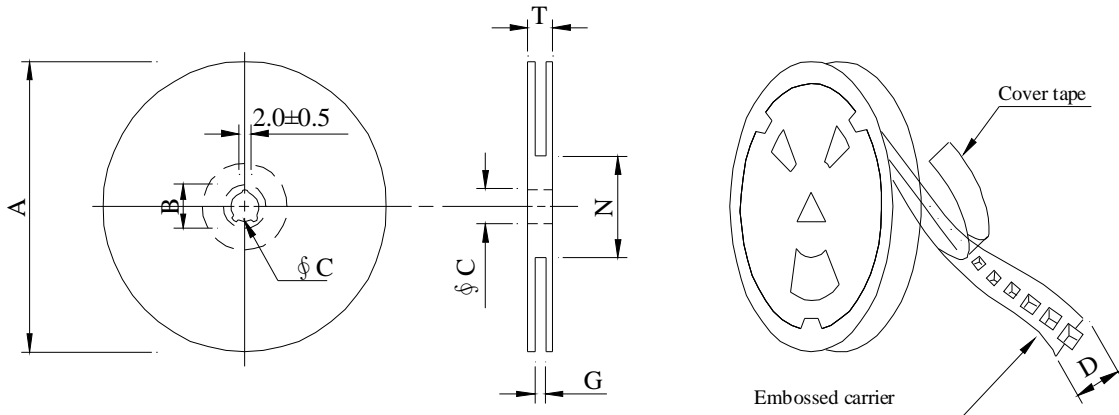

※Carrier tape width : D

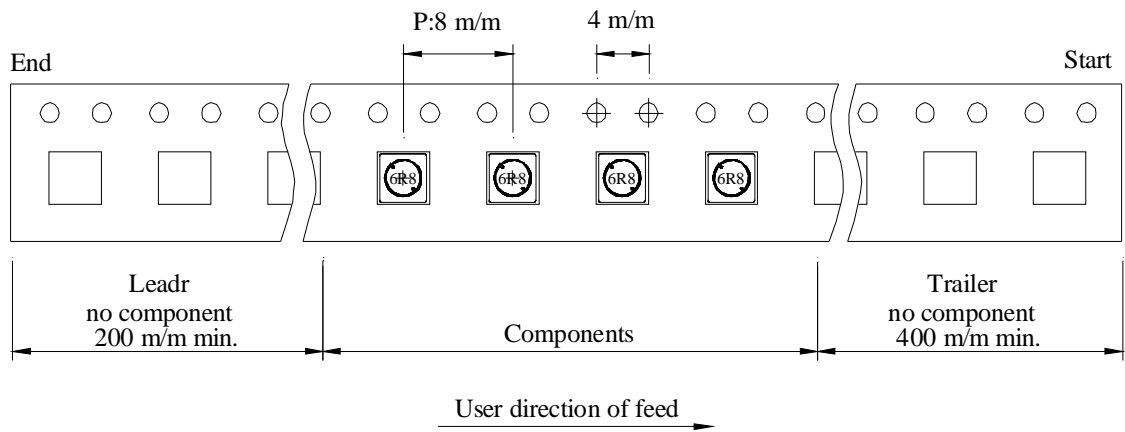

(2) Dimensions

Unit:m/m

Style	A	B	C	D	G	N	T
07 - 12	178	21±0.8	13	12	14 ⁺⁰	50 ⁻⁰	16.5

(3) Q'TY & G.W. Per package

Series	Inner : Reel			Outer : Carton		
	Q'TY (pcs)	G.W. (gw)	Style	Q'TY (pcs)	G.W. (Kg)	Size (cm)
SH4018	800	135	07 - 12	32,000	8.20	42 x 41 x 24
SH4018	1,000	170	07 - 12	40,000	10.30	42 x 41 x 24

AR-001A

SPECIFICATION FOR APPROVAL

REF : 20090506-B

PAGE: 4

PROD. NAME	SHIELDED SMD POWER INDUCTOR	ABC'S DWG NO.	SH4018□□□□L□-□□□
		ABC'S ITEM NO.	

VII . DWGING NUMBER EXPRESSION :

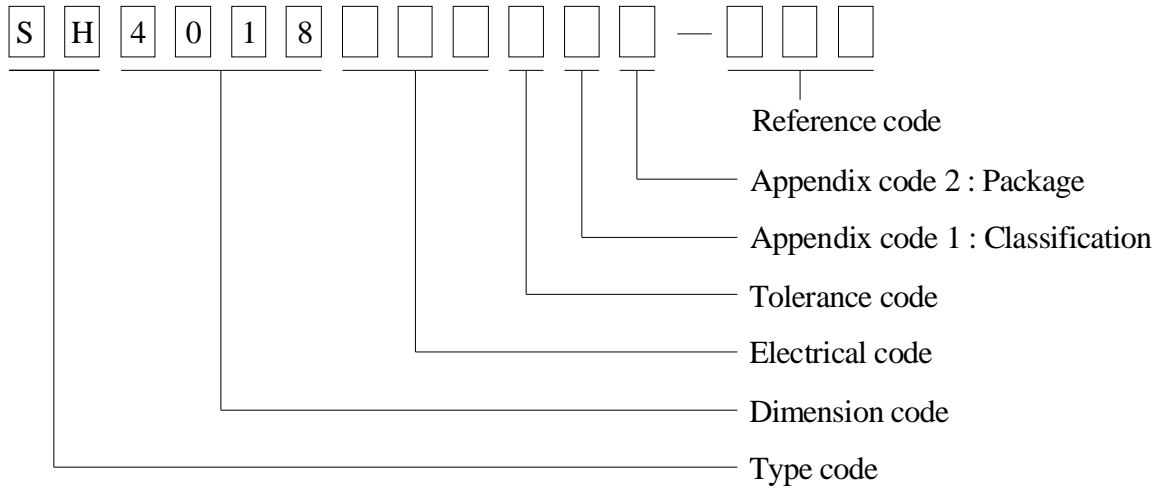

Appendix code 1 : Product Classification

- L : Lead Free Standard products comply with RoHS' requirements
- 1 ~ 9 : Lead Free Special products comply with RoHS' requirements

Appendix code 2 : Package Information

Code	Inner package	Inner package Q'TY	Remark
A	T.B.D.	T.B.D.	
B	T / R (Reel package)	800 pcs	
C	T / R (Reel package)	1,000 pcs	

SPECIFICATION FOR APPROVAL

REF : 20090506-B

PAGE: 5

PROD. NAME	SHIELDED SMD POWER INDUCTOR	ABC'S DWG NO. ABC'S ITEM NO.	SH4018□□□□L□-□□□
---------------	--------------------------------	---------------------------------	------------------

VIII . RELIABILITY TEST :

Test item	Specification	Test condition						
Solderability	More than 95% of the terminal electrode shall be covered With fresh solder.	Preheat : 155°C / 4 hours. Solder : Sn96.5 / Ag3 / Cu0.5 or equivalent Solder temp. : 235±5°C Flux : Rosin Dip time : 5±0.5 seconds						
Thermal shock test (Temp. cycle)	Electrical oharacteristics shall not change more than ±20%	<table style="width: 100%; border: none;"> <tr> <td style="text-align: center;">Room temp. 15 minutes</td> <td style="text-align: center;">→</td> <td style="text-align: center;">-40 °C 30 minutes</td> </tr> <tr> <td style="text-align: center;">Room temp. 15 minutes</td> <td style="text-align: center;">→</td> <td style="text-align: center;">+105 °C 30 minutes</td> </tr> </table> <p>Total : 50 cycles</p>	Room temp. 15 minutes	→	-40 °C 30 minutes	Room temp. 15 minutes	→	+105 °C 30 minutes
Room temp. 15 minutes		→	-40 °C 30 minutes					
Room temp. 15 minutes		→	+105 °C 30 minutes					
Humidity test		Temperature : 40±2°C Humidity : 90±5% Time : 1000 hours						
High temp. Resistance test	Temperature : 105±5°C Applied current : Per spec. Time : 96 hours							

SPECIFICATION FOR APPROVAL

REF : 20090506-B

PAGE: 6

PROD. NAME	SHIELDED SMD POWER INDUCTOR	ABC'S DWG NO.	SH4018□□□□L□-□□□
		ABC'S ITEM NO.	

IX . UL CARD :

OBMW2 September 8, 2000
Magnet Wire-Component
JUNG SHING WIRE CO LTD E174837
231 CHUNG CHENG RD, SEC 3 JEN-TEH HSIANG, TAINAN
HSIEN TAIWAN

Mtl Dsg	Mark Dsg	BC	Coat Typ	OC	ANSI Type	Temp Class
AIW	---	Polyamideimide		---	MW81-C	220
CFUEWB	---	Polyurethane		---	MW75C	130
EIAIW	---	Polyesterimide		Polyamideimide	MW35C	200
EILOCKY	---	Polyesterimide		Polyamide	---	180
EILOCKW	---	Polyesterimide		Modified Epoxy	---	200
EIW	---	Polyesterimide		---	---	220
EIW-2	---	Polyesterimide		---	MW74-C	200
FL.EILOCKY	---	Modified Polyester		Polyamide	---	155
LSFFW	---	Polyurethane		---	MW79-C	155
LSUEW	---	Polyurethane		---	---	130
PEW	---	Polyester		---	---	155
PEY	---	Polyester		Nylon	MW24-C	155
SF.FLW	---	Modified Polyester		---	MW26C	155
SF.EIW	---	Polyesterimide		---	MW77C	180
SF.BY@	---	Modified Polyester		Nylon	MW27-C	155
SF.FLY@	---	Modified Polyester		Nylon	MW27-C	155
SF.BLOCKBS	---	Modified Polyester		Modified Polyamide	---	155
SF.EILOCKY#	---	Polyesterimide		Polyamide	---	180
SF.EILOCKBS	---	Polyesterimide		Modified Polyamide	---	180
SF.BW@	---	Modified Polyester		---	MW26C	155
SFFW	---	Polyurethane		---	MW79	155

287806002 Page 1 of 2

A not-for-profit organization dedicated to public safety and committed to quality service

Mtl Dsg	Mark Dsg	BC	Coat Typ	OC	ANSI Type	Temp Class
SFFY	---	Polyurethane		Polyamide	MW80C	155
UEW-1	---	Polyurethane		---	MW2-C	105
UEW-2	---	Polyurethane		---	---	130
UEW-4	---	Polyurethane		---	MW75C	130
UEY	---	Polyurethane		Nylon	MW28-C	130
UEY-2	---	Polyurethane		Polyamide	MW28-C	130

287806002 Page 2 of 2

OBMW2E174837
September 8 , 2000

@-May be suffixed by LZ; # - May be suffixed by LZ, EL or LZI.
LZ - Signifies magened wires twisted together; EL - signifies base coated magnet wire laid parallel with top coat applied overall; LZL - signifies base coated magnet wire twisted together and covered with top coat overall.
Marking: Company name or trademarks JSW or 榮星電線 , material designation or marked designation on packaed or reel, and Recognized Component Mark.
See General Information Preceding These Recognitions
For use only in equipment where the acceptability of the combination is determined by Underwriters Laboratories Inc.

AR-001A



SPECIFICATION FOR APPROVAL

REF : 20090506-B

PAGE: 7

PROD. NAME	SHIELDED SMD POWER INDUCTOR	ABC'S DWG NO.	SH4018□□□□L□-□□□
		ABC'S ITEM NO.	

OBMW2 October 06, 2005

Magnet Wire-Component

ELEKTRISOLA (MALAYSLA) SDN BHD E143312

JALAN DAMAI SATU JANDA BAIK 28750 BENTONG, PAHANG
DARUL MAKMUR MALAYSIA

Mtl Dsg	Mark Dsg	Coating Type		ANSI Typ	Temp Class
		BC	OC		
Estersol 180	E180	Polyesterimide (solderable)	---	MW-77	180
Amldester 200	A200	Polyesterimide	---	MW-74	200
Polysol-N 155	PN155	Polyurethane	Nylon	MW-80, MW-28	155, 130
Polysol 155	P155, G155	Polyurethane	---	MW-79, MW-75	155, 130
Polysol 155g	Pg155	Polyurethane	---	MW-75	130
Polysol 155p	Pp155,Gp155	Polyurethane	---	MW-79	155
Polysol 160	P160	Polyurethane	---	MW-79	155
Polysol 180	P180,G180	Polyurethane	---	MW-82, MW-79	180, 155
Polysol 170	P170 or G170	Polyurethane	---	MW-79	155
Polysol-N 180	PN180	Polyurethane	Nylon	MW-83	180
Polysol P155p	P155p	Polyurethane	---	MW-79	155

Marking : Company name, material designation or marked designation and factory identification on package ok reel

See General Information preceding These Recognitions

For use only in equipment where the acceptability of the combination is determined by Underwriters Laboratories Inc.

AR-001A

