

# Heterojunction Bipolar Transistor (InGaP HBT)

## Broadband High Linearity Amplifier

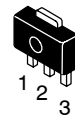
The MMG3007NT1 is a General Purpose Amplifier that is internally input and output matched. It is designed for a broad range of Class A, small-signal, high linearity, general purpose applications. It is suitable for applications with frequencies from 0 to 6000 MHz such as Cellular, PCS, BWA, WLL, PHS, CATV, VHF, UHF, UMTS and general small-signal RF.

### Features

- Frequency: 0 to 6000 MHz
- P1dB: 16 dBm @ 900 MHz
- Small-Signal Gain: 19 dB @ 900 MHz
- Third Order Output Intercept Point: 30 dBm @ 900 MHz
- Single 5 Volt Supply
- Internally Matched to 50 Ohms
- Low Cost SOT-89 Surface Mount Package
- RoHS Compliant
- In Tape and Reel. T1 Suffix = 1000 Units per 12 mm, 7 inch Reel.

**MMG3007NT1**

**0-6000 MHz, 19 dB  
16 dBm  
InGaP HBT**



**CASE 1514-02, STYLE 1  
SOT-89  
PLASTIC**

**Table 1. Typical Performance (1)**

Characteristic	Symbol	900 MHz	2140 MHz	3500 MHz	Unit
Small-Signal Gain (S21)	G <sub>p</sub>	19	16.5	14	dB
Input Return Loss (S11)	IRL	-14	-21	-21	dB
Output Return Loss (S22)	ORL	-20	-17	-25	dB
Power Output @1dB Compression	P1db	16	15.5	16	dBm
Third Order Output Intercept Point	IP3	30	29	28.5	dBm

1. V<sub>CC</sub> = 5 Vdc, T<sub>C</sub> = 25°C, 50 ohm system

**Table 2. Maximum Ratings**

Rating	Symbol	Value	Unit
Supply Voltage	V <sub>CC</sub>	7	V
Supply Current	I <sub>CC</sub>	250	mA
RF Input Power	P <sub>in</sub>	10	dBm
Storage Temperature Range	T <sub>stg</sub>	-65 to +150	°C
Junction Temperature (2)	T <sub>J</sub>	150	°C

2. For reliable operation, the junction temperature should not exceed 150°C.

**Table 3. Thermal Characteristics** (V<sub>CC</sub> = 5 Vdc, I<sub>CC</sub> = 47 mA, T<sub>C</sub> = 25°C)

Characteristic	Symbol	Value (3)	Unit
Thermal Resistance, Junction to Case	R <sub>θJC</sub>	77	°C/W

3. Refer to AN1955, *Thermal Measurement Methodology of RF Power Amplifiers*. Go to <http://www.freescale.com/rt>. Select Documentation/Application Notes - AN1955.

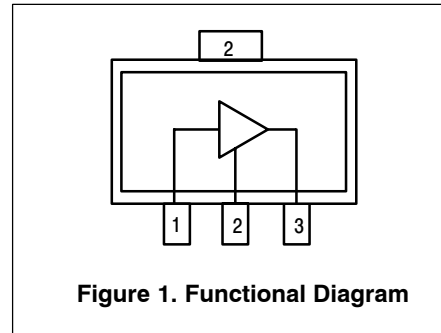
**Table 4. Electrical Characteristics** ( $V_{CC} = 5$  Vdc, 900 MHz,  $T_C = 25^\circ\text{C}$ , 50 ohm system, in Freescale Application Circuit)

Characteristic	Symbol	Min	Typ	Max	Unit
Small-Signal Gain (S21)	$G_p$	18	19	—	dB
Input Return Loss (S11)	IRL	—	-14	—	dB
Output Return Loss (S22)	ORL	—	-20	—	dB
Power Output @ 1dB Compression	P1dB	—	16	—	dBm
Third Order Output Intercept Point	IP3	—	30	—	dBm
Noise Figure	NF	—	3.8	—	dB
Supply Current (1)	$I_{CC}$	39	47	55	mA
Supply Voltage (1)	$V_{CC}$	—	5	—	V

1. For reliable operation, the junction temperature should not exceed  $150^\circ\text{C}$ .

**Table 5. Functional Pin Description**

Pin Number	Pin Function
1	RF <sub>in</sub>
2	Ground
3	RF <sub>out</sub> /DC Supply

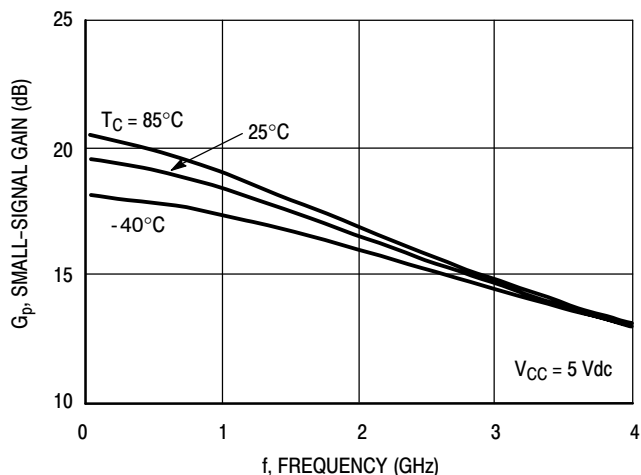
**Table 6. ESD Protection Characteristics**

Test Methodology	Class
Human Body Model (per JESD 22-A114)	1A (Minimum)
Machine Model (per EIA/JESD 22-A115)	A (Minimum)
Charge Device Model (per JESD 22-C101)	IV (Minimum)

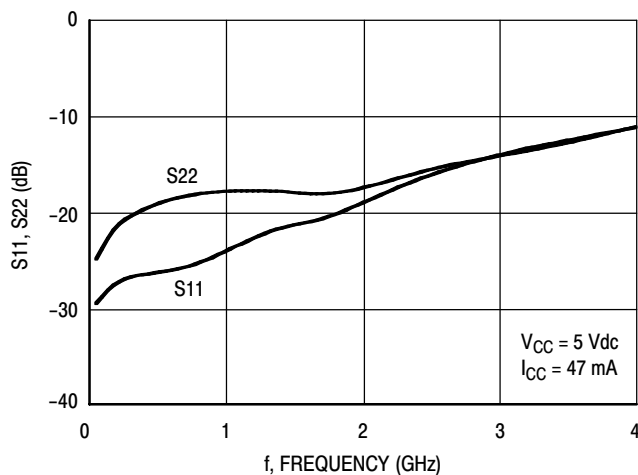
**Table 7. Moisture Sensitivity Level**

Test Methodology	Rating	Package Peak Temperature	Unit
Per JESD 22-A113, IPC/JEDEC J-STD-020	1	260	°C

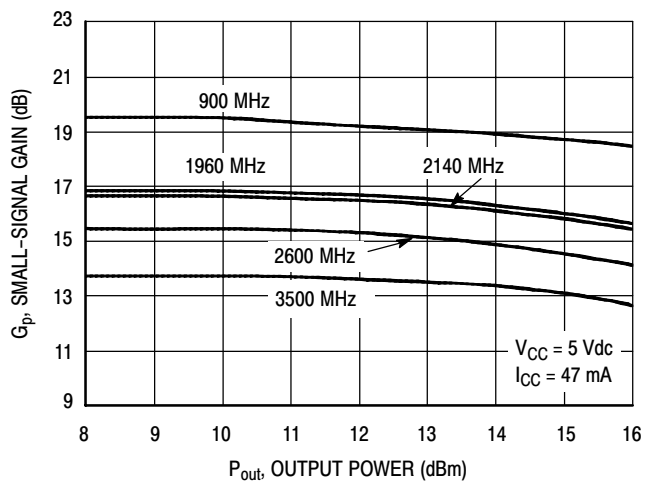
## 50 OHM TYPICAL CHARACTERISTICS



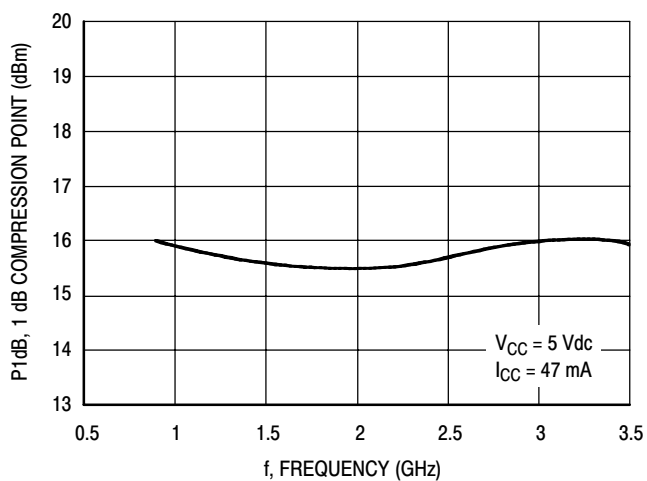
**Figure 2. Small-Signal Gain (S21) versus Frequency**



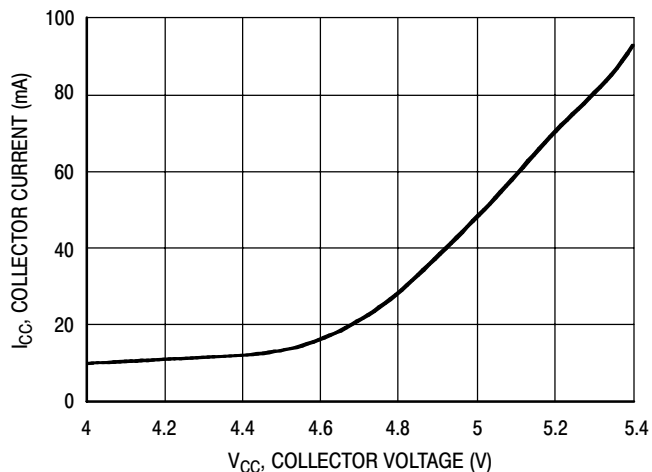
**Figure 3. Input/Output Return Loss versus Frequency**



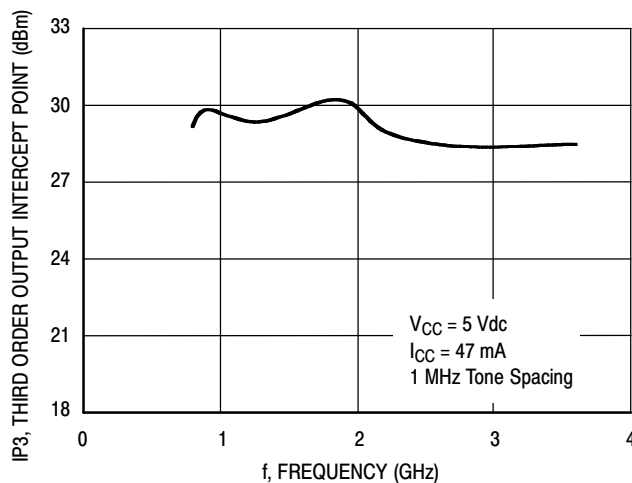
**Figure 4. Small-Signal Gain versus Output Power**



**Figure 5. P1dB versus Frequency**

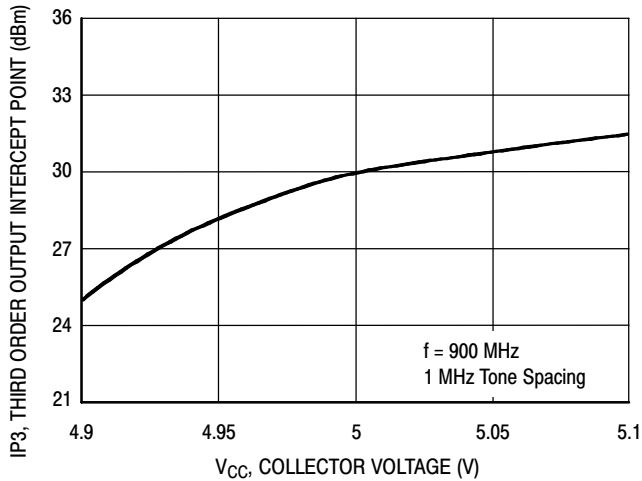


**Figure 6. Collector Current versus Collector Voltage**

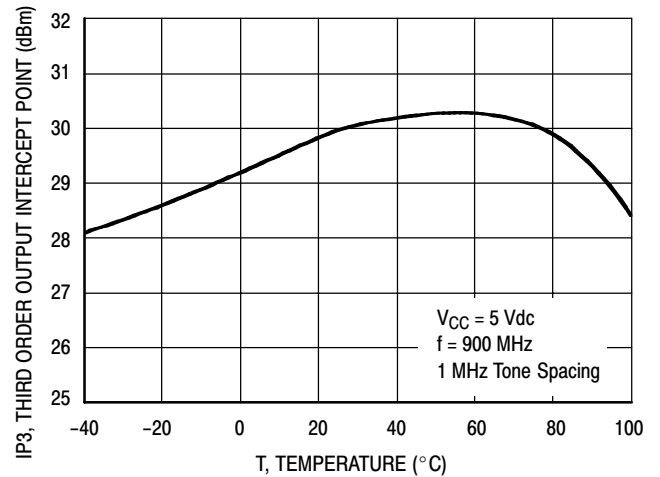


**Figure 7. Third Order Output Intercept Point versus Frequency**

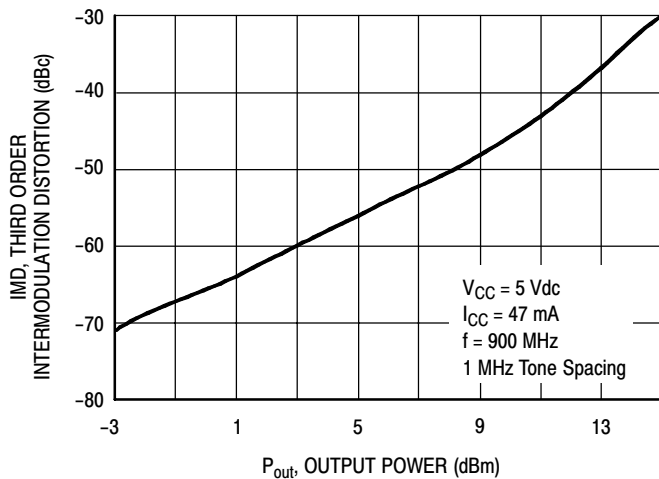
## 50 OHM TYPICAL CHARACTERISTICS



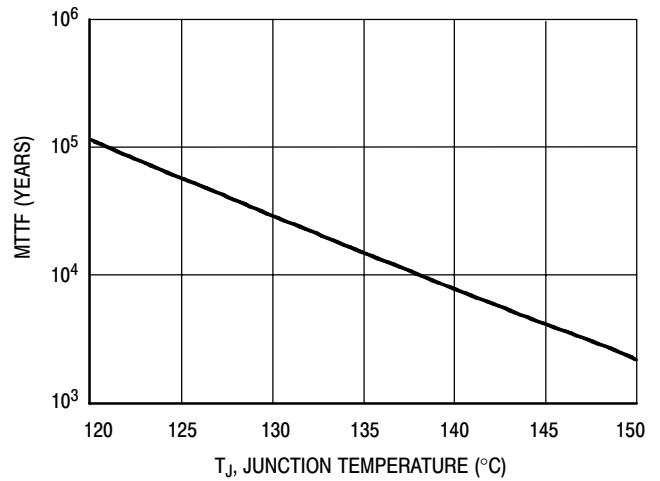
**Figure 8. Third Order Output Intercept Point versus Collector Voltage**



**Figure 9. Third Order Output Intercept Point versus Case Temperature**

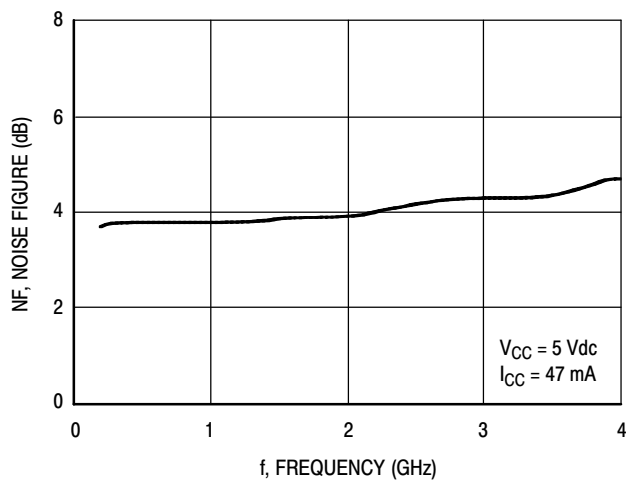


**Figure 10. Third Order Intermodulation versus Output Power**

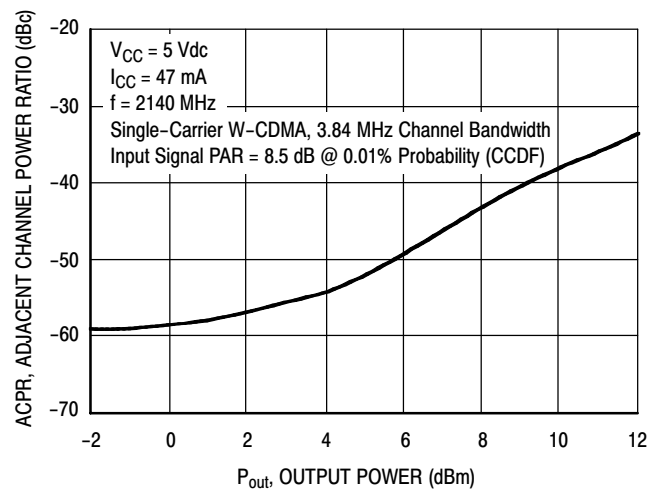


NOTE: The MTTF is calculated with  $V_{CC} = 5 \text{ Vdc}$ ,  $I_{CC} = 47 \text{ mA}$

**Figure 11. MTTF versus Junction Temperature**



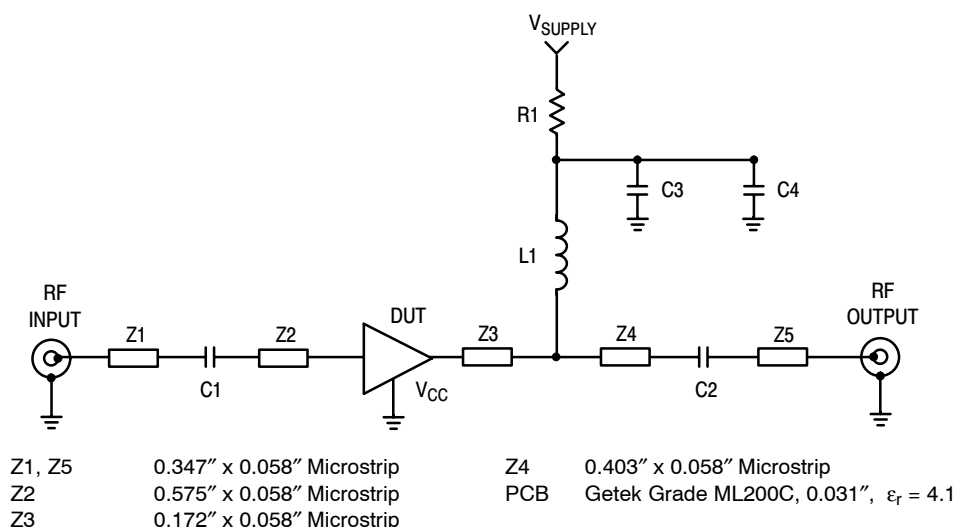
**Figure 12. Noise Figure versus Frequency**



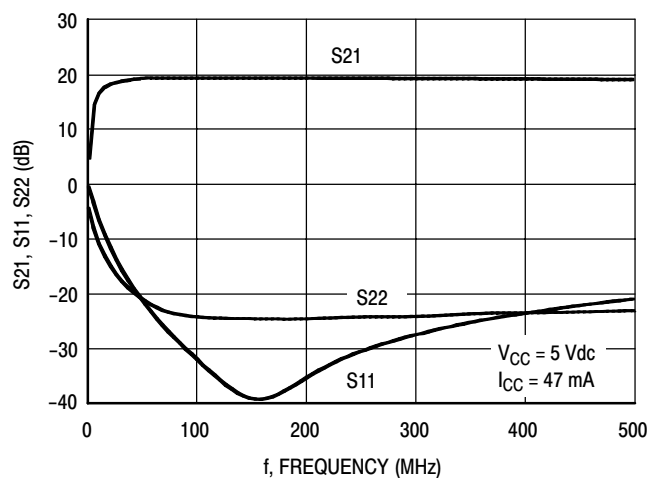
**Figure 13. Single-Carrier W-CDMA Adjacent Channel Power Ratio versus Output Power**

MMG3007NT1

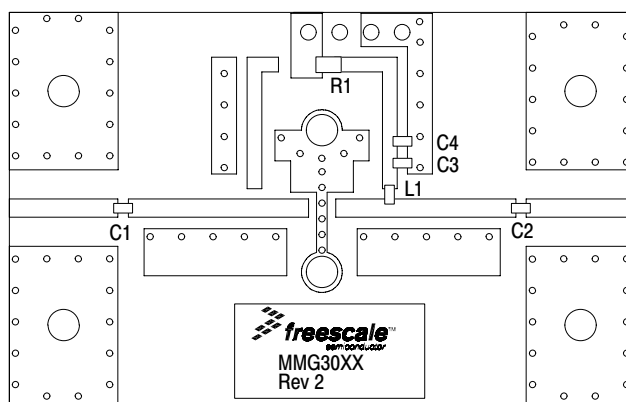
## 50 OHM APPLICATION CIRCUIT: 40-300 MHz



**Figure 14. 50 Ohm Test Circuit Schematic**



**Figure 15. S21, S11 and S22 versus Frequency**

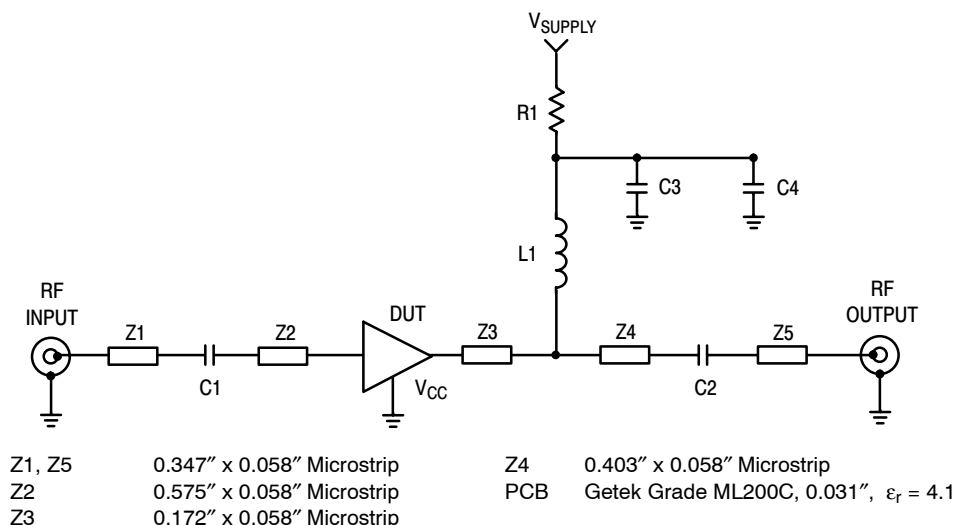


**Figure 16. 50 Ohm Test Circuit Component Layout**

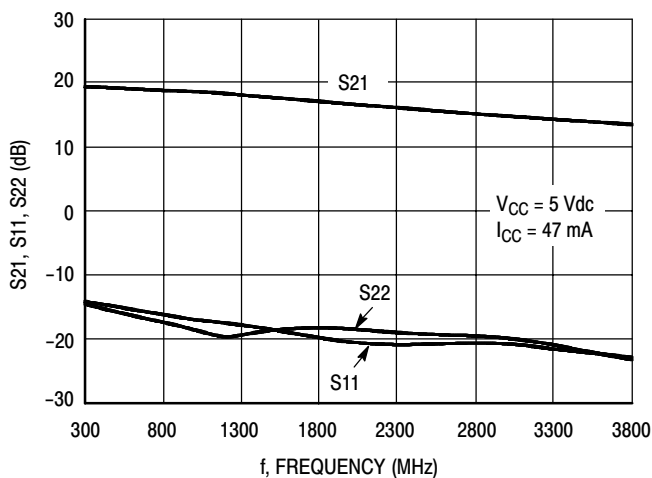
**Table 8. 50 Ohm Test Circuit Component Designations and Values**

Part	Description	Part Number	Manufacturer
C1, C2, C3	0.01 $\mu$ F Chip Capacitors	C0603C103J5RAC	Kemet
C4	1000 pF Chip Capacitor	C0603C102J5RAC	Kemet
L1	470 nH Chip Inductor	BK2125HM471-T	Taiyo Yuden
R1	0 $\Omega$ Chip Resistor	ERJ3GEY0R00V	Panasonic

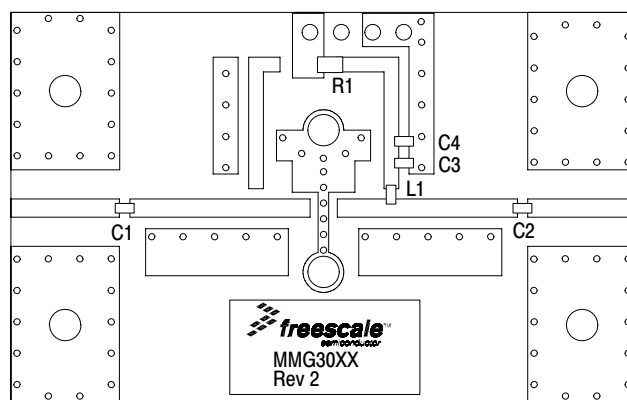
## 50 OHM APPLICATION CIRCUIT: 300-3600 MHz



**Figure 17. 50 Ohm Test Circuit Schematic**



**Figure 18. S21, S11 and S22 versus Frequency**



**Figure 19. 50 Ohm Test Circuit Component Layout**

**Table 9. 50 Ohm Test Circuit Component Designations and Values**

Part	Description	Part Number	Manufacturer
C1, C2	150 pF Chip Capacitors	C0603C151J5RAC	Kemet
C3	0.01 $\mu$ F Chip Capacitor	C0603C103J5RAC	Kemet
C4	1000 pF Chip Capacitor	C0603C102J5RAC	Kemet
L1	56 nH Chip Inductor	HK160856NJ-T	Taiyo Yuden
R1	0 $\Omega$ Chip Resistor	ERJ3GEY0R00V	Panasonic

## 50 OHM TYPICAL CHARACTERISTICS

**Table 10. Common Emitter S-Parameters** ( $V_{CC} = 5 \text{ Vdc}$ ,  $I_{CC} = 47 \text{ mA}$ ,  $T_C = 25^\circ\text{C}$ , 50 Ohm System)

f MHz	S <sub>11</sub>		S <sub>21</sub>		S <sub>12</sub>		S <sub>22</sub>	
	S <sub>11</sub>	∠ φ	S <sub>21</sub>	∠ φ	S <sub>12</sub>	∠ φ	S <sub>22</sub>	∠ φ
100	0.03698	162.744	9.488476	175.169	0.07218	-0.406	0.06601	-6.062
150	0.0413	161.759	9.431009	172.714	0.073936	-0.163	0.07813	-11.706
200	0.04475	159.333	9.37615	169.547	0.07479	-1.111	0.089562	-18.834
250	0.046352	159.222	9.34083	167.191	0.0744	-1.219	0.09748	-25.724
300	0.048403	155.469	9.29558	164.704	0.07458	-1.237	0.10124	-32.775
350	0.05	151.008	9.26495	162.138	0.07444	-1.639	0.10466	-36.946
400	0.0499	147.696	9.21219	159.65	0.07473	-1.957	0.10811	-41.977
450	0.04922	144.11	9.16094	157.234	0.07499	-2.087	0.11164	-46.631
500	0.04838	141.343	9.10787	154.702	0.07517	-2.464	0.11391	-50.846
550	0.04902	137.521	9.04991	152.326	0.07536	-2.681	0.11765	-55.096
600	0.04911	134.226	8.98419	149.922	0.07567	-2.89	0.11998	-59.312
650	0.0497	130.851	8.91939	147.525	0.07584	-3.227	0.12163	-63.354
700	0.05086	127.93	8.85099	145.201	0.07618	-3.577	0.12411	-67.411
750	0.05247	124.848	8.78068	142.838	0.07642	-3.81	0.12586	-71.332
800	0.05441	122.43	8.70765	140.522	0.07659	-4.138	0.12711	-75.244
850	0.05624	120.786	8.63598	138.198	0.07702	-4.463	0.12825	-79.297
900	0.05818	118.791	8.5575	135.918	0.0774	-4.812	0.12922	-83.181
950	0.06054	117.037	8.47718	133.677	0.07767	-5.244	0.13	-87.373
1000	0.06284	115.852	8.40286	131.466	0.07806	-5.558	0.13077	-91.474
1050	0.06676	114.603	8.31905	129.243	0.07848	-5.948	0.13124	-95.143
1100	0.06962	113.845	8.23305	127.045	0.07874	-6.3	0.13158	-99.674
1150	0.07142	114.019	8.14799	124.84	0.07912	-6.731	0.13134	-104.011
1200	0.07473	113.644	8.05859	122.666	0.07962	-7.194	0.13136	-108.404
1250	0.07822	113.329	7.97269	120.536	0.07992	-7.652	0.13147	-112.847
1300	0.08137	113.158	7.89042	118.443	0.08035	-8.105	0.1318	-117.291
1350	0.08501	112.83	7.80455	116.374	0.08077	-8.476	0.13257	-121.809
1400	0.085621	112.341	7.71693	114.349	0.08135	-8.943	0.13274	-126.4
1450	0.08691	112.503	7.62844	112.301	0.08168	-9.492	0.130129	-130.945
1500	0.087447	112.516	7.55444	110.29	0.08226	-9.966	0.127178	-132.429
1550	0.088958	110.702	7.46781	108.325	0.08275	-10.605	0.125783	-135.873
1600	0.088598	108.771	7.39276	106.371	0.08326	-11.086	0.12282	-139.82
1650	0.089575	107.354	7.30109	104.406	0.08366	-11.654	0.1228	-142.9
1700	0.09071	105.666	7.2314	102.488	0.0841	-12.158	0.12308	-146.866
1750	0.0938	104.101	7.15066	100.592	0.08459	-12.724	0.12424	-150.805
1800	0.097	102.621	7.07137	98.688	0.0851	-13.319	0.12564	-154.586
1850	0.10094	101.285	6.98725	96.791	0.08555	-13.926	0.12718	-158.448
1900	0.10562	99.475	6.90714	94.976	0.08607	-14.507	0.12895	-162.5
1950	0.10927	97.823	6.83262	93.117	0.0865	-15.154	0.13127	-166.07
2000	0.11424	96.4	6.75439	91.288	0.08691	-15.771	0.13415	-169.355
2050	0.11811	94.531	6.67977	89.43	0.08733	-16.325	0.13706	-172.886
2100	0.12221	93.106	6.60249	87.648	0.08781	-17.024	0.14095	-175.782
2150	0.12585	91.879	6.53055	85.88	0.0884	-17.685	0.14488	-179.155
2200	0.13197	90.391	6.44752	84.16	0.08868	-18.268	0.14844	178.18
2250	0.13625	88.624	6.37451	82.389	0.08924	-18.993	0.15223	175.153

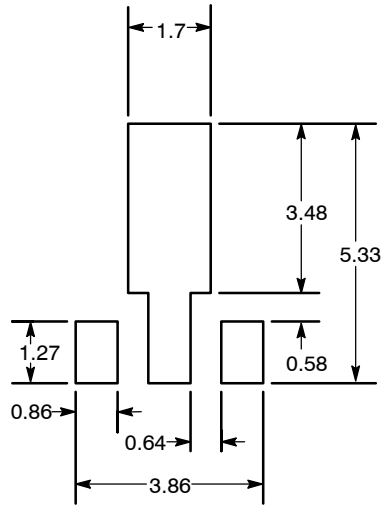
(continued)



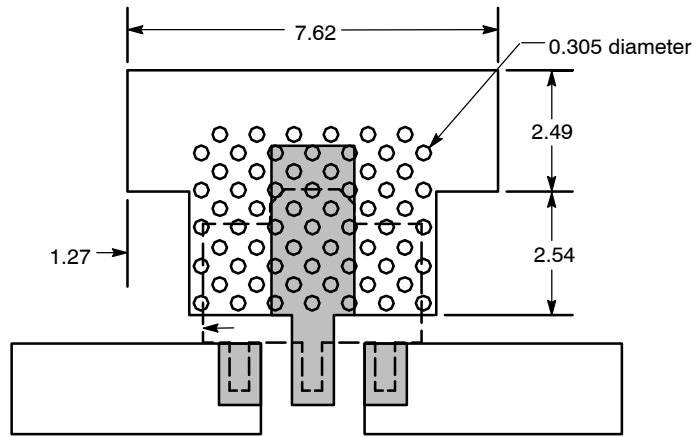
## 50 OHM TYPICAL CHARACTERISTICS

**Table 10. Common Emitter S-Parameters** ( $V_{CC} = 5 \text{ Vdc}$ ,  $I_{CC} = 47 \text{ mA}$ ,  $T_C = 25^\circ\text{C}$ , 50 Ohm System) (continued)

f MHz	S <sub>11</sub>		S <sub>21</sub>		S <sub>12</sub>		S <sub>22</sub>	
	S <sub>11</sub>	∠φ	S <sub>21</sub>	∠φ	S <sub>12</sub>	∠φ	S <sub>22</sub>	∠φ
2300	0.14158	86.951	6.30389	80.681	0.08971	-19.632	0.15572	172.537
2350	0.14606	85.398	6.23166	78.989	0.09007	-20.321	0.15962	170.114
2400	0.15065	83.971	6.16179	77.288	0.09053	-20.98	0.16279	167.517
2450	0.15511	82.457	6.09153	75.581	0.09088	-21.711	0.16641	165.072
2500	0.15948	80.991	6.02115	73.906	0.09142	-22.394	0.16996	162.826
2550	0.16385	79.722	5.95767	72.273	0.09177	-23.024	0.17342	160.459
2600	0.16854	78.35	5.89249	70.612	0.09216	-23.702	0.17676	157.989
2650	0.17283	76.864	5.82721	68.994	0.09255	-24.506	0.17953	155.564
2700	0.17698	75.562	5.76221	67.358	0.09293	-25.194	0.18268	153.165
2750	0.18126	74.328	5.70193	65.748	0.09333	-25.926	0.18543	150.629
2800	0.1858	72.976	5.64062	64.155	0.09391	-26.671	0.18837	148.259
2850	0.18957	71.773	5.58104	62.533	0.09428	-27.402	0.19087	145.593
2900	0.19403	70.699	5.52616	60.973	0.09472	-28.203	0.19395	143.044
2950	0.19798	69.575	5.46422	59.362	0.09518	-28.947	0.19629	140.485
3000	0.20132	68.53	5.41159	57.778	0.09558	-29.733	0.19941	137.461
3050	0.20676	67.445	5.36032	56.228	0.09592	-30.462	0.20221	135.101
3100	0.21059	66.347	5.30349	54.654	0.09653	-31.263	0.20477	132.383
3150	0.21388	65.517	5.25234	53.104	0.09687	-32.035	0.20796	129.58
3200	0.21774	64.628	5.20188	51.53	0.09729	-32.944	0.21083	126.913
3250	0.22229	63.76	5.15023	49.962	0.09771	-33.702	0.21442	124.314
3300	0.22492	62.653	5.10104	48.396	0.09812	-34.531	0.21656	121.289
3350	0.2287	61.882	5.05108	46.866	0.09855	-35.414	0.22001	118.535
3400	0.23228	60.924	5.00022	45.297	0.099	-36.284	0.2241	115.888
3450	0.2365	60.161	4.95117	43.756	0.09926	-37.17	0.22826	113.148
3500	0.24039	59.326	4.90461	42.216	0.09948	-38.046	0.23275	110.547
3550	0.24401	58.457	4.85739	40.692	0.09979	-38.943	0.23669	107.983
3600	0.24834	57.659	4.80824	39.155	0.10008	-39.768	0.24177	105.495



Recommended Solder Stencil

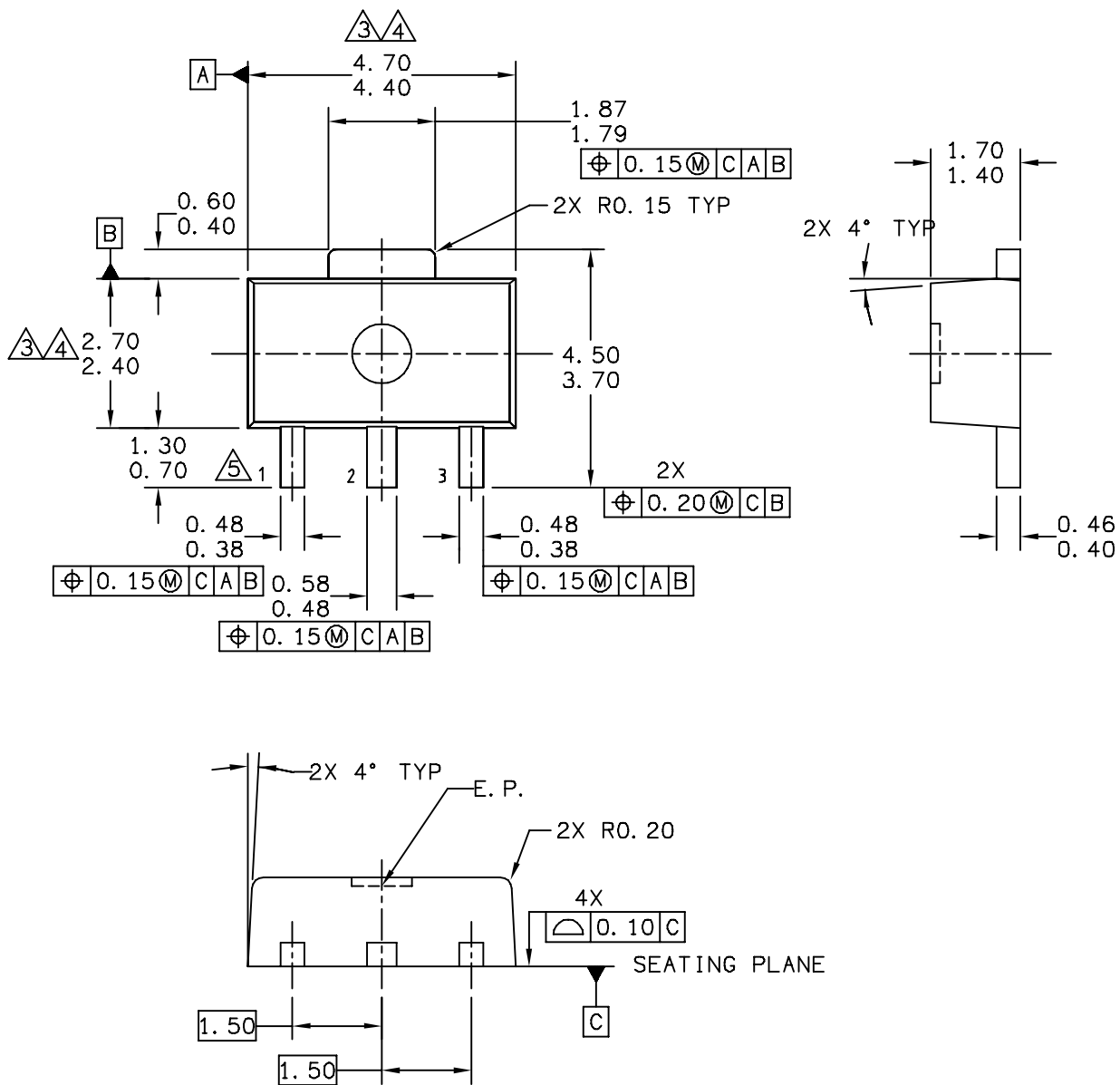


NOTES:

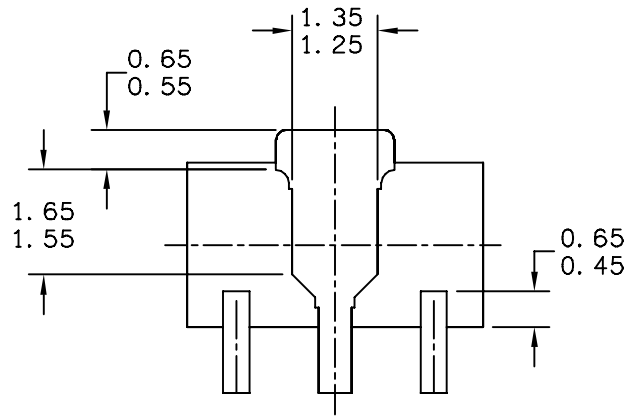
1. THERMAL AND RF GROUNDING CONSIDERATIONS SHOULD BE USED IN PCB LAYOUT DESIGN.
2. DEPENDING ON PCB DESIGN RULES, AS MANY VIAS AS POSSIBLE SHOULD BE PLACED ON THE LANDING PATTERN.
3. IF VIAS CANNOT BE PLACED ON THE LANDING PATTERN, THEN AS MANY VIAS AS POSSIBLE SHOULD BE PLACED AS CLOSE TO THE LANDING PATTERN AS POSSIBLE FOR OPTIMAL THERMAL AND RF PERFORMANCE.
4. RECOMMENDED VIA PATTERN SHOWN HAS 0.381 x 0.762 MM PITCH.

Figure 20. Recommended Mounting Configuration

PACKAGE DIMENSIONS



<p>© FREESCALE SEMICONDUCTOR, INC. ALL RIGHTS RESERVED.</p>	<p><b>MECHANICAL OUTLINE</b></p>	<p>PRINT VERSION NOT TO SCALE</p>	
<p>TITLE: SOT-89, 4 LEAD, 4.5 X 2.5 PKG, 1.5 MM PITCH</p>	<p>DOCUMENT NO: 98ASA10586D</p>	<p>REV: D</p>	
	<p>CASE NUMBER: 1514-02</p>	<p>27 JUN 2007</p>	
	<p>STANDARD: NON-JEDEC</p>		



BOTTOM VIEW

CASE STYLE:

STYLE 1:

PIN 1. RF INPUT  
 PIN 2. GROUND  
 PIN 3. RF OUTPUT

STYLE 2:

PIN 1. GATE  
 PIN 2. SOURCE  
 PIN 3. DRAIN

© FREESCALE SEMICONDUCTOR, INC. ALL RIGHTS RESERVED.	<b>MECHANICAL OUTLINE</b>	PRINT VERSION NOT TO SCALE	
TITLE: SOT-89, 4 LEAD, 4.5 X 2.5 PKG, 1.5 MM PITCH	DOCUMENT NO: 98ASA10586D	REV: D	
	CASE NUMBER: 1514-02	27 JUN 2007	
	STANDARD: NON-JEDEC		

NOTES:

1 DIMENSIONING AND TOLERANCING PER ASME Y14.5M – 1994.

2 ALL DIMENSIONS ARE IN MILLIMETERS.

3 DIMENSIONS DOES NOT INCLUDE MOLD FLASH, PROTRUSIONS OR GATE BURRS. MOLD FLASH, PROTRUSIONS OR GATE BURRS SHALL NOT EXCEED 0.5mm PER END. DIMENSION DOES NOT INCLUDE INTERLEAD FLASH OR PROTRUSION. INTERLEAD FLASH OR PROTRUSION SHALL NOT EXCEED 0.5 mm PER SIDE.

4 DIMENSION ARE DETERMINED AT THE OUTMOST EXTREMES OF THE PLASTIC BODY EXCLUSIVE OF MOLD FLASH, TIE BAR BURRS, GATE BURRS AND INTERLEAD FLASH, BUT INCLUDING ANY MISMATCH BETWEEN THE TOP AND BOTTOM OF THE PLASTIC BODY.

5 TERMINAL NUMBERS ARE SHOWN FOR REFERENCE ONLY.

© FREESCALE SEMICONDUCTOR, INC. ALL RIGHTS RESERVED.	<b>MECHANICAL OUTLINE</b>	PRINT VERSION NOT TO SCALE	
TITLE: SOT-89, 4 LEAD, 4.5 X 2.5 PKG, 1.5 MM PITCH	DOCUMENT NO: 98ASA10586D	REV: D	
	CASE NUMBER: 1514-02	27 JUN 2007	
	STANDARD: NON-JEDEC		

## PRODUCT DOCUMENTATION

Refer to the following documents to aid your design process.

### Application Notes

- AN1955: Thermal Measurement Methodology of RF Power Amplifiers
- AN3100: General Purpose Amplifier Biasing

## REVISION HISTORY

The following table summarizes revisions to this document.

Revision	Date	Description
3	Mar. 2007	<ul style="list-style-type: none"><li>• Corrected and updated Part Numbers in Tables 8 and 9, Component Designations and Values, to RoHS compliant part numbers, p. 6, 7</li></ul>
4	July 2007	<ul style="list-style-type: none"><li>• Replaced Case Outline 1514-01 with 1514-02, Issue D, p. 1, 11-13. Case updated to add missing dimension for Pin 1 and Pin 3.</li></ul>
5	Mar. 2008	<ul style="list-style-type: none"><li>• Removed Footnote 2, Continuous voltage and current applied to device, from Table 2, Maximum Ratings, p. 1</li><li>• Corrected Fig. 13, Single-Carrier W-CDMA Adjacent Channel Power Ratio versus Output Power y-axis (ACPR) unit of measure to dBc, p. 5</li><li>• Corrected S-Parameter table frequency column label to read "MHz" versus "GHz" and corrected frequency values from GHz to MHz, p. 8, 9</li></ul>

## **How to Reach Us:**

### **Home Page:**

[www.freescale.com](http://www.freescale.com)

### **Web Support:**

<http://www.freescale.com/support>

### **USA/Europe or Locations Not Listed:**

Freescale Semiconductor, Inc.  
Technical Information Center, EL516  
2100 East Elliot Road  
Tempe, Arizona 85284  
+1-800-521-6274 or +1-480-768-2130  
[www.freescale.com/support](http://www.freescale.com/support)

### **Europe, Middle East, and Africa:**

Freescale Halbleiter Deutschland GmbH  
Technical Information Center  
Schatzbogen 7  
81829 Muenchen, Germany  
+44 1296 380 456 (English)  
+46 8 52200080 (English)  
+49 89 92103 559 (German)  
+33 1 69 35 48 48 (French)  
[www.freescale.com/support](http://www.freescale.com/support)

### **Japan:**

Freescale Semiconductor Japan Ltd.  
Headquarters  
ARCO Tower 15F  
1-8-1, Shimo-Meguro, Meguro-ku,  
Tokyo 153-0064  
Japan  
0120 191014 or +81 3 5437 9125  
[support.japan@freescale.com](mailto:support.japan@freescale.com)

### **Asia/Pacific:**

Freescale Semiconductor Hong Kong Ltd.  
Technical Information Center  
2 Dai King Street  
Tai Po Industrial Estate  
Tai Po, N.T., Hong Kong  
+800 2666 8080  
[support.asia@freescale.com](mailto:support.asia@freescale.com)

### **For Literature Requests Only:**

Freescale Semiconductor Literature Distribution Center  
P.O. Box 5405  
Denver, Colorado 80217  
1-800-441-2447 or 303-675-2140  
Fax: 303-675-2150  
[LDCForFreescaleSemiconductor@hibbertgroup.com](mailto:LDCForFreescaleSemiconductor@hibbertgroup.com)

Information in this document is provided solely to enable system and software implementers to use Freescale Semiconductor products. There are no express or implied copyright licenses granted hereunder to design or fabricate any integrated circuits or integrated circuits based on the information in this document.

Freescale Semiconductor reserves the right to make changes without further notice to any products herein. Freescale Semiconductor makes no warranty, representation or guarantee regarding the suitability of its products for any particular purpose, nor does Freescale Semiconductor assume any liability arising out of the application or use of any product or circuit, and specifically disclaims any and all liability, including without limitation consequential or incidental damages. "Typical" parameters that may be provided in Freescale Semiconductor data sheets and/or specifications can and do vary in different applications and actual performance may vary over time. All operating parameters, including "Typicals", must be validated for each customer application by customer's technical experts. Freescale Semiconductor does not convey any license under its patent rights nor the rights of others. Freescale Semiconductor products are not designed, intended, or authorized for use as components in systems intended for surgical implant into the body, or other applications intended to support or sustain life, or for any other application in which the failure of the Freescale Semiconductor product could create a situation where personal injury or death may occur. Should Buyer purchase or use Freescale Semiconductor products for any such unintended or unauthorized application, Buyer shall indemnify and hold Freescale Semiconductor and its officers, employees, subsidiaries, affiliates, and distributors harmless against all claims, costs, damages, and expenses, and reasonable attorney fees arising out of, directly or indirectly, any claim of personal injury or death associated with such unintended or unauthorized use, even if such claim alleges that Freescale Semiconductor was negligent regarding the design or manufacture of the part.

Freescale™ and the Freescale logo are trademarks of Freescale Semiconductor, Inc. All other product or service names are the property of their respective owners.

© Freescale Semiconductor, Inc. 2005-2008. All rights reserved.

