

General Description

The AAT4670 SmartSwitch is a member of AnalogicTech's Application Specific Power MOSFET™ (ASPM™) product family. The AAT4670 consists of dual, independent, 1A current limited, slew rate controlled P-channel MOSFET power switches with a dedicated source and drain pin assigned to each switch. The internal circuitry automatically derives power from the higher of the two input power source pins with a low operating quiescent current of 18μA. In shutdown mode, the supply current decreases to less than 1μA. The switches operate with inputs ranging from 2.2V to 5.5V, making them ideal for 2.5V, 3V, and 5V systems. The dual configuration permits integration of the load switch function for systems with two different power busses. Independent under-voltage lockout circuits will shut down the corresponding switch if its input voltage falls below the under-voltage lockout threshold. If the die temperature reaches the thermal limit, both switches thermal cycle off and on indefinitely without damage until the thermal condition is removed. An open drain $\overline{\text{FAULT}}$ output signals an over-current or over-temperature condition for each channel. Input logic levels are TTL compatible.

The AAT4670 is available in a Pb-free, space-saving, thermally-enhanced TDFN 3x3x0.8mm 12-lead package. The device is also available in a Pb-free 8-pin SOP, TSSOP, or MSOP package and is specified over the -40°C to +85°C temperature range.

Features

- 2.2V to 5.5V Input Voltage Range
- 1A Current Limit Per Channel
- 95mΩ Typical $R_{DS(ON)}$
- Fast Transient Response:
 - <1μs Response to Short Circuit
- Low 18μA Quiescent Current
- 1μA Max with Switches Off
- Slew Rate Controlled
- Thermal Shutdown
- Fault Flags with 3ms Blanking
- Under-Voltage Lockout
- Temperature Range: -40°C to +85°C
- Available in TDFN33-12, SOP-8, TSSOP-8, or MSOP-8 Package

Applications

- Hot Swap Supplies
- Media Bay
- Notebook Computer
- PDA, Subnotebook
- Peripheral Ports
- USB Ports

Typical Application

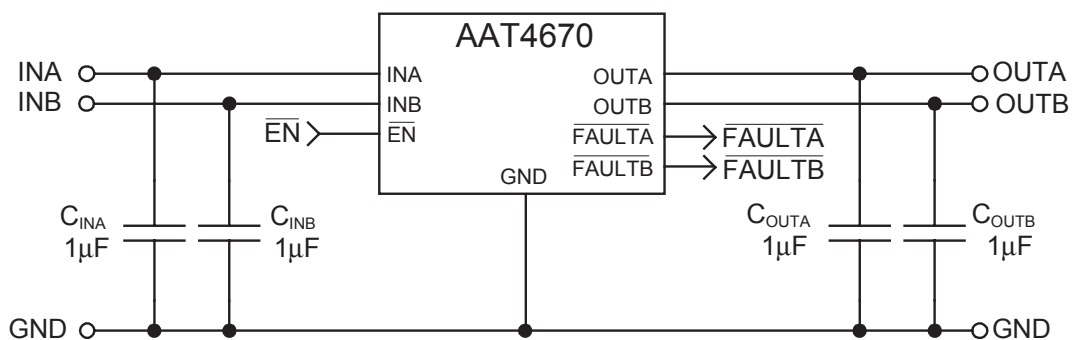

Pin Descriptions

Pin #		Symbol	Function
TDFN	Other Pkgs		
1, 12	8	OUTA	P-channel MOSFET drain channel A.
2	1	$\overline{\text{EN}}$	Active-low enable input (logic low turns the switches on).
3	2	$\overline{\text{FAULTA}}$	Open drain output; signals over-current for OUTA and over-temperature condition.
4	3	$\overline{\text{FAULTB}}$	Open drain output; signals over-current for OUTB and over-temperature condition.
5	4	GND	Ground connection.
6, 7	5	OUTB	P-channel MOSFET drain channel B.
8, 9	6	INB	P-channel MOSFET source channel B.
10, 11	7	INA	P-channel MOSFET source channel A.
EP			Exposed paddle (bottom); connect to ground as closely as possible to the device.

Pin Configuration

TDFN33-12

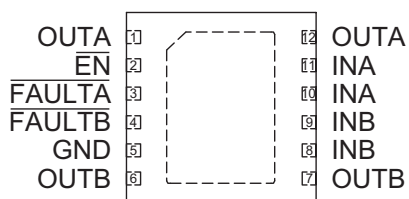

SOP-8

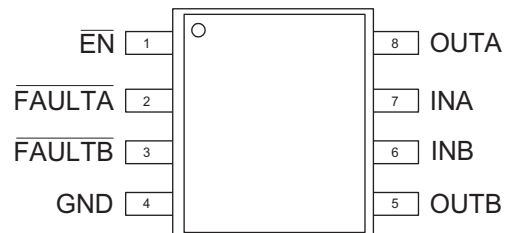

TSSOP-8

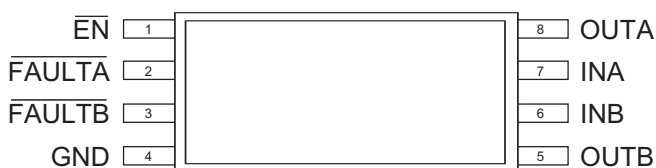

MSOP-8

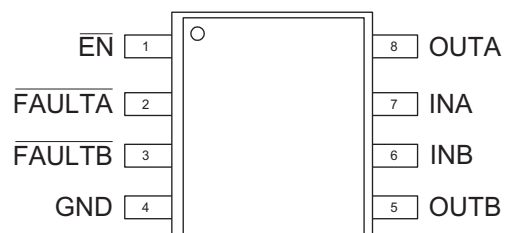

Absolute Maximum Ratings¹

$T_A = 25^\circ\text{C}$, unless otherwise noted.

Symbol	Description	Value	Units
$V_{INA,B}$	INA or INB to GND	-0.3 to 6	V
$V_{OUTA,B}$	OUTA or OUTB to GND	-0.3 to 6	V
$V_{FAULTA,B}$	FAULTA or FAULTB to GND	-0.3 to 6	V
I_{OUT}	Output Current	Internally Limited	A
T_J	Operating Junction Temperature Range	-40 to 150	$^\circ\text{C}$
V_{ESD}	ESD Rating ² - HBM	4000	V
T_{LEAD}	Maximum Soldering Temperature (at Leads)	300	$^\circ\text{C}$

Thermal Characteristics³

Symbol	Description		Value	Units
θ_{JA}	Maximum Thermal Resistance	SOP-8	100	$^\circ\text{C}/\text{W}$
		TDFN33-12	50	
P_D	Maximum Power Dissipation	SOP-8	1.25	W
		TDFN33-12	2.0	

1. Stresses above those listed in Absolute Maximum Ratings may cause permanent damage to the device. Functional operation at conditions other than the operating conditions specified is not implied. Only one Absolute Maximum Rating should be applied at any one time.
2. Human body model is a 100pF capacitor discharged through a 1.5k Ω resistor into each pin.
3. Mounted on a demo board.

Electrical Characteristics

$V_{IN} = 5V$, $T_A = 25^\circ C$, unless otherwise noted. **Bold** values designate $-40^\circ C$ to $+85^\circ C$ temperature range.

Symbol	Description	Conditions	Min	Typ	Max	Units
V_{IN}	Operation Voltage		2.2		5.5	V
I_Q	Quiescent Current	V_{INA} or $V_{INB} = 5V$, $I_{OUTA} = I_{OUTB} = 0$		18	40	μA
$I_{Q(OFF)}$	Off Supply Current	$\overline{EN} = V_{IN}$, $V_{INA} = V_{INB} = 5V$, $OUTA$, $OUTB$ Open			1	μA
$I_{SD(OFF)}$	Off Switch Current	$\overline{EN} = V_{IN}$, $V_{INA} = V_{INB} = 5V$, $V_{OUTA} = V_{OUTB} = 0V$		0.1	1	μA
V_{UVLO}	Under-Voltage Lockout			1.7	2.2	V
$R_{DS(ON)}$	On-Resistance Channel A or B	$V_{IN} = 5.0V$		95	130	m Ω
		$V_{IN} = 3.0V$		105	150	
T_{CRDS}	Switch Resistance Temperature Coefficient			2800		ppm/ $^\circ C$
I_{LIM}	Current Limit Channel A or B	$V_{OUT} < V_{IN}$ to 0.5V	1.0	1.25	1.50	A
t_1	Output Turn-On Delay Time	$V_{IN} = 5V$, $OUT = 0$ to 10%, $R_{LOAD} = 20\Omega$		100	1000	μs
t_2	Output Rise Time	$V_{IN} = 5V$, $OUT = 10\%$ to 90%, $R_{LOAD} = 20\Omega$		100	1000	μs
t_3	Output Turn-Off Delay Time	$V_{IN} = 5V$, $OUT = 100\%$ to 90%, $R_{LOAD} = 20\Omega$		10	20	μs
t_4	Output Fall Time	$V_{IN} = 5V$, $OUT = 90\%$ to 10%, $R_{LOAD} = 20\Omega$		5	20	μs
$V_{EN(L)}$	EN Input Low Voltage	$V_{IN} = 2.7V$ to $5.5V^1$			0.8	V
$V_{EN(H)}$	EN Input High Voltage	$V_{IN} = 2.7V$ to $< 3.6V$	2.0			V
		$V_{IN} = 3.6V$ to $5.5V$	2.4			
$I_{EN(SINK)}$	EN Input Leakage	$V_{EN} = 5.5V$		0.01	1	μA
t_{RESP}	Current Loop Response	$V_{IN} = 5V$		750		ns
$V_{FAULTLOW}$	\overline{FAULT} Logic Output Low	$I_{SINK} = 1mA$			0.4	V
I_{SINK}	\overline{FAULT} Logic Output High Leakage Current	$V_{FAULT} = 5.5V$		0.5	1	μA
T_{blank}	Fault Blanking Time			3		ms
T_{SD}	Over-Temperature Threshold			125		$^\circ C$

1. For V_{IN} outside this range, consult typical EN threshold curve.

Typical Characteristics

Quiescent Current vs. Temperature

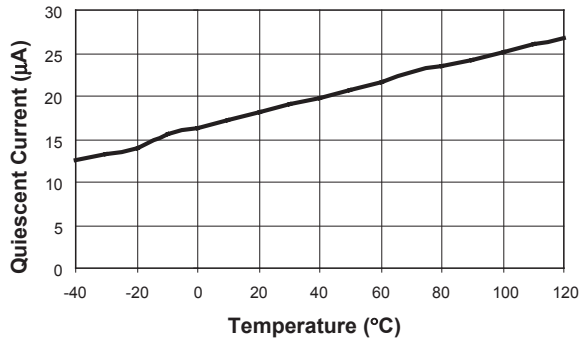

Quiescent Current vs. Input Voltage

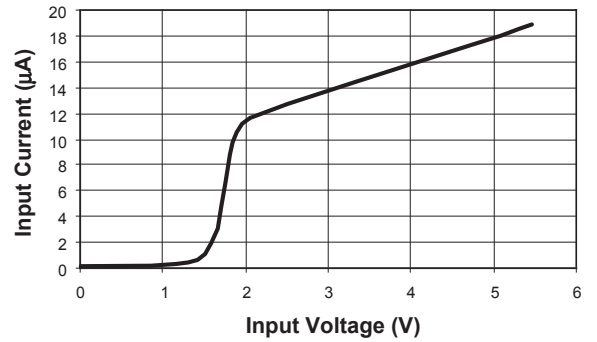

Off-Supply Current vs. Temperature

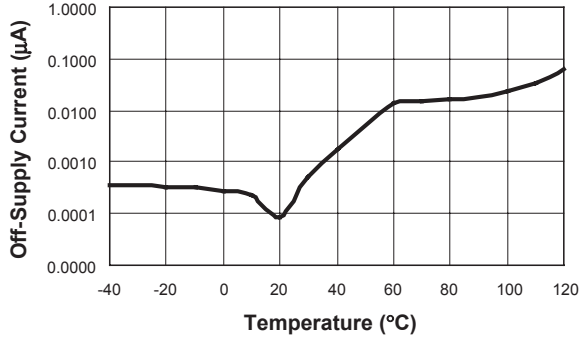

Off-Switch Current vs. Temperature

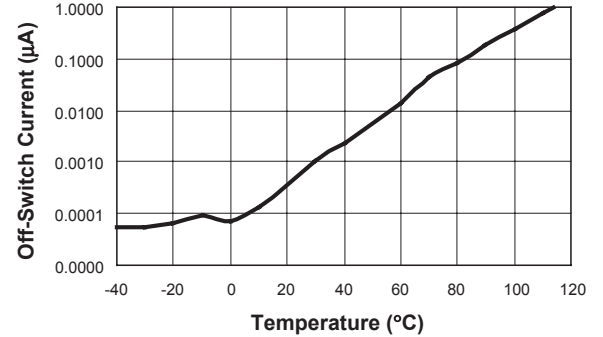

Current Limit vs. Output Voltage

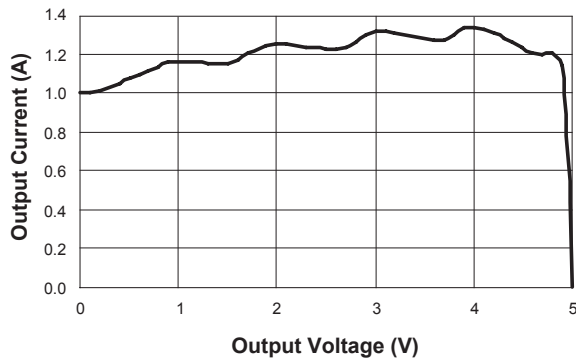

$R_{DS(ON)}$ vs. Temperature

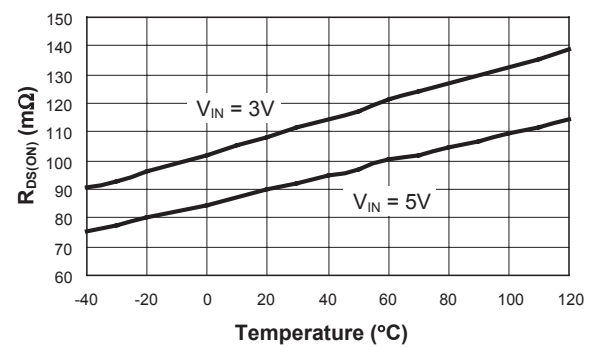

Typical Characteristics

Turn-On/Off Response with 20Ω 1μF Loads

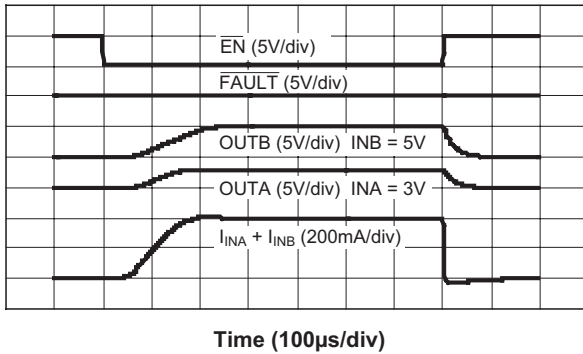

FAULT Delay Start Into 0.6Ω Load

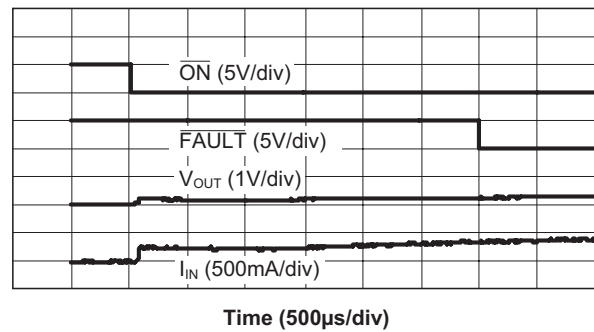

Short Circuit Through 0.6Ω

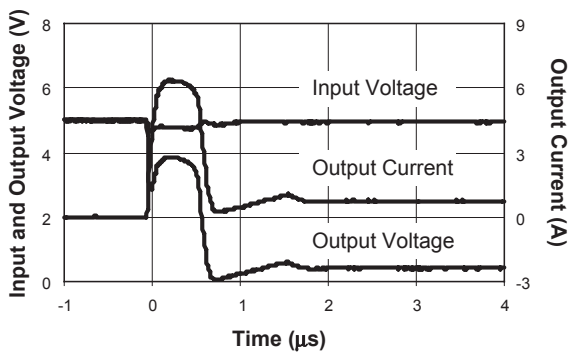

Short Circuit Through 0.3Ω

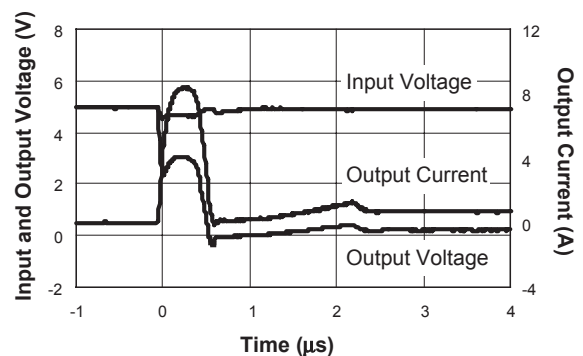

Thermal Shutdown Response

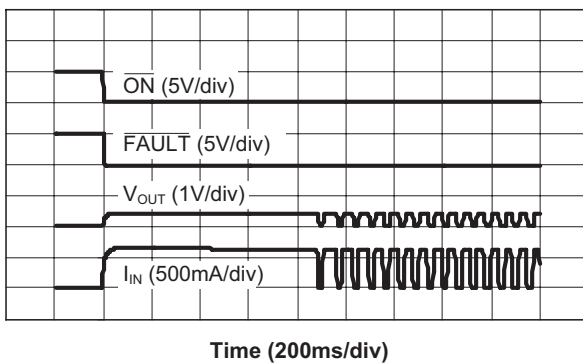

Typical EN Threshold vs. Input Voltage

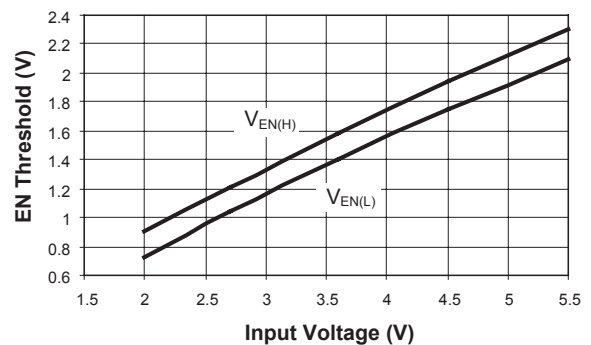

Functional Block Diagram

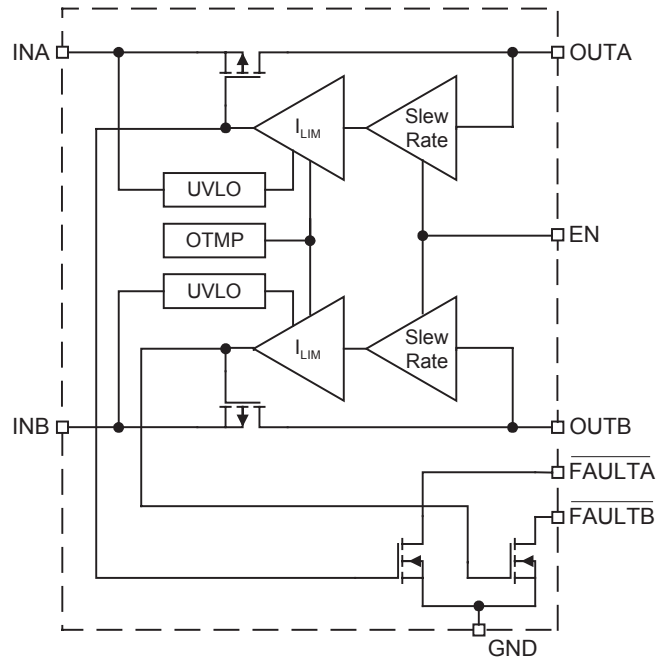

Functional Description

The AAT4670 dual channel load switch, implemented with isolated independent P-channel MOSFET devices, is ideal for applications where dual power supplies are in continuous use. Typical applications for this include products with multiple USB ports, or ports requiring protection that operate from separate power supplies. The input power supplies can be any voltage between 2.2V and 5.5V in any combination; one supply is not required to be the higher voltage. Internally, the power supply for the control circuitry will automatically switch to the higher of the two supplies. In the case where the supplies are equal, $\pm 30\text{mV}$ of hysteresis prevents the internal supply from oscillating between the two input supplies. The low impedance P-channel MOSFET devices are identical in size, allowing for layout flexibility. They are controlled by a patented fast acting current loop and respond to short circuits in a fraction of a microsecond, easing requirements on the input capacitors. With such fast transient response time, the upstream power supply rail is naturally isolated from the protected port.

The AAT4670 is internally protected from thermal damage by an over-temperature detection circuit. If

a high ambient temperature or an over-current condition causes the die temperature to reach the internal thermal limit, both power devices are switched off until the die temperature cools to a level below the thermal limit threshold. The device will thermal cycle indefinitely until the over-current or high temperature condition is removed. Due to the high thermal conductivity of silicon and the size of the die, the temperature across the die is relatively uniform at high temperatures; therefore, as a precaution, both power devices are switched off when the thermal threshold is reached. Since the power devices operate from independent power supplies, independent under-voltage lockout circuits are employed. If the power supply to one channel falls below the under-voltage lockout threshold, the other channel will remain active. A current limit condition is reported by the open drain $\overline{\text{FAULT}}$ output associated with the appropriate channel. A thermal limit condition is reported by both $\overline{\text{FAULT}}$ outputs. A three millisecond blanking interval prevents false reporting during the charging of a capacitive load, which typically occurs during device turn-on, but may also occur during a port hot plug-in event.

The AAT4670 is ideally suited for protection of peripheral ports such as USB, PS2, and parallel ports.

Applications Information

Input Capacitor

The input capacitors, C_{INA} and C_{INB} , protect the input power supplies from current transients generated by loads attached to the AAT4670. If a short circuit is suddenly applied to an output of the AAT4670, there is a 750 nanosecond period during which a large current flows before current limit circuitry activates. (See characteristic curve "Short Circuit Through 0.3Ω .") In this event, a properly sized input capacitor can dramatically reduce the voltage transient seen by the power supply and other circuitry upstream from the AAT4670. C_{IN} should be located as close to the device VIN pin as practically possible. Ceramic, tantalum, or aluminum electrolytic capacitors may be selected for C_{IN} . There is no specific capacitor equivalent series resistance (ESR) requirement for C_{IN} . However, for higher current operation, ceramic capacitors are recommended for C_{IN} due to their inherent capability over tantalum capacitors to withstand input current surges from low impedance sources such as batteries in portable devices.

Output Capacitor

In order to insure stability while the current limit is active, a small capacitance of approximately $1\mu\text{F}$ is required on each output. No matter how big the output capacitor, output current is limited to the value set by the AAT4670 current limiting circuitry, allowing very large output capacitors to be used. For example, USB ports are specified to have at least $120\mu\text{F}$ of capacitance downstream from their controlling power switch. The current limiting circuit will allow an output capacitance of $1000\mu\text{F}$ or more without disturbing the upstream power supply.

Attaching Loads

Capacitive loads attached to the AAT4670 will charge at a rate no greater than the current limit setting.

FAULT Output

FAULT flags are provided to alert the system if an AAT4670 load is not receiving sufficient voltage to operate properly. If current limit or over-temperature circuits in any combination are active for more

than approximately three milliseconds, the associated FAULT flag is pulled to ground through approximately 100Ω . Removal of voltage or current transients of less than three milliseconds prevents capacitive loads connected to either AAT4670 output from activating the associated FAULT flag when they are initially attached. Pull-up resistances of $1\text{k}\Omega$ to $100\text{k}\Omega$ are recommended. Since FAULT is an open drain terminal, it may be pulled up to any unrelated voltage less than the maximum operating voltage of 5.5V , allowing for level shifting between circuits.

Thermal Considerations

Since the AAT4670 has internal current limit and over-temperature protection, junction temperature is rarely a concern. However, if the application requires large currents in a hot environment, it is possible that temperature, rather than current limit, will be the dominant regulating condition. In these applications, the maximum current available without risk of an over-temperature condition must be calculated. The maximum internal temperature while current limit is not active can be calculated using Equation 1.

$$\text{Eq. 1: } T_{J(\text{MAX})} = I_{\text{MAX}}^2 \cdot R_{\text{DS(ON)(MAX)}} \cdot R_{\theta\text{JA}} + T_{\text{A(MAX)}}$$

In Equation 1, I_{MAX} is the maximum current required by the load. $R_{\text{DS(ON)(MAX)}}$ is the maximum rated $R_{\text{DS(ON)}}$ of the AAT4670 at high temperature. $R_{\theta\text{JA}}$ is the thermal resistance between the AAT4670 die and the board onto which it is mounted. $T_{\text{A(MAX)}}$ is the maximum temperature that the PCB under the AAT4670 would be if the AAT4670 were not dissipating power. Equation 1 can be rearranged to solve for I_{MAX} ; Equation 2.

$$\text{Eq. 2: } I_{\text{MAX}} = \sqrt{\frac{T_{\text{SD(MIN)}} - T_{\text{A(MAX)}}}{R_{\text{DS(ON)(MAX)}} \cdot R_{\theta\text{JA}}}}$$

$T_{\text{SD(MIN)}}$ is the minimum temperature required to activate the AAT4670 over-temperature protection. With typical specification of 125°C , 115°C is a safe minimum value to use.

For example, if an application is specified to operate in 50°C environments, the PCB operates at temperatures as high as 85°C. The application is sealed and its PCB is small, causing $R_{\theta JA}$ to be approximately 120°C/W. Using Equation 2:

To prevent thermal limiting, the operating load current in the application must be less than 1.25A which lies in the current limiting range. So, in this application, any operating current below the current limit threshold is allowed.

Eq. 3:
$$I_{MAX} = \sqrt{\frac{115 - 85}{160m \cdot 120}} = 1.25A$$

Timing Diagram

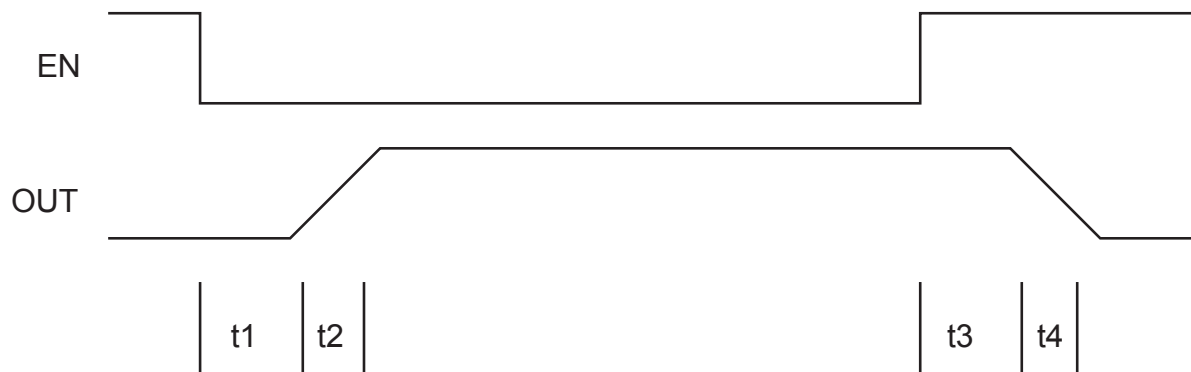

Ordering Information

Package	Marking ¹	Part Number (Tape and Reel) ²
SOP-8	4670	AAT4670IAS-T1
TSSOP-8	4670	AAT4670IHS-T1
MSOP-8	BFXYY	AAT4670IKS-T1
TDFN33-12		AAT4670IWP-T1



All AnalogicTech products are offered in Pb-free packaging. The term “Pb-free” means semiconductor products that are in compliance with current RoHS standards, including the requirement that lead not exceed 0.1% by weight in homogeneous materials. For more information, please visit our website at <http://www.analogictech.com/pbfree>.

Package Information

SOP-8

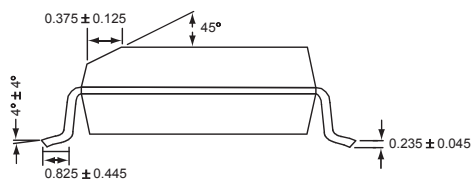
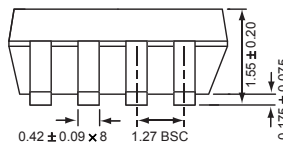
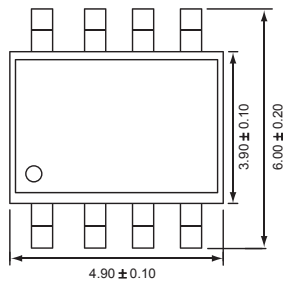

All dimensions in millimeters.

1. XYY = assembly and date code.
 2. Sample stock is generally held on part numbers listed in **BOLD**.

TSSOP-8

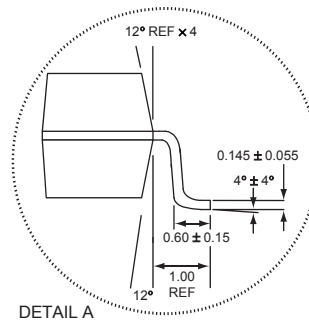
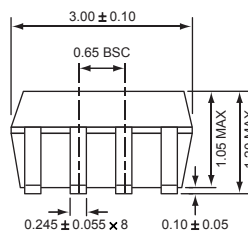
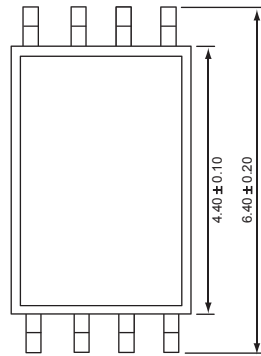

All dimensions in millimeters.

MSOP-8

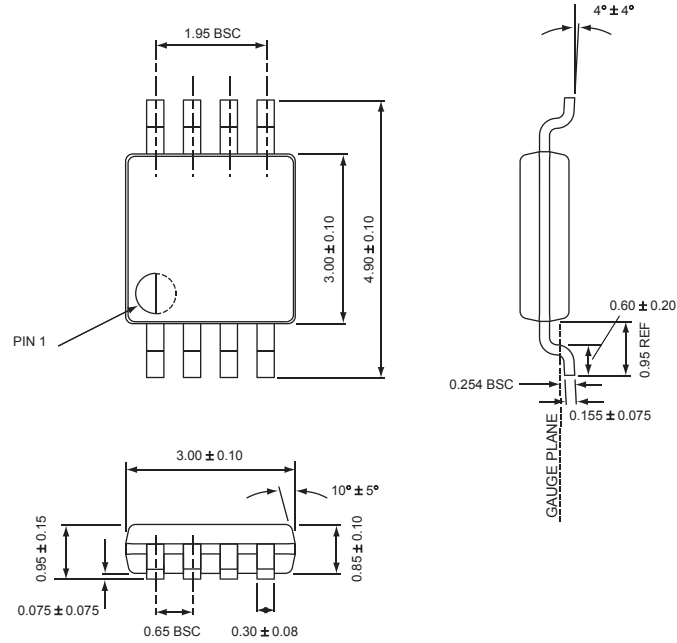

All dimensions in millimeters.

TDFN33-12

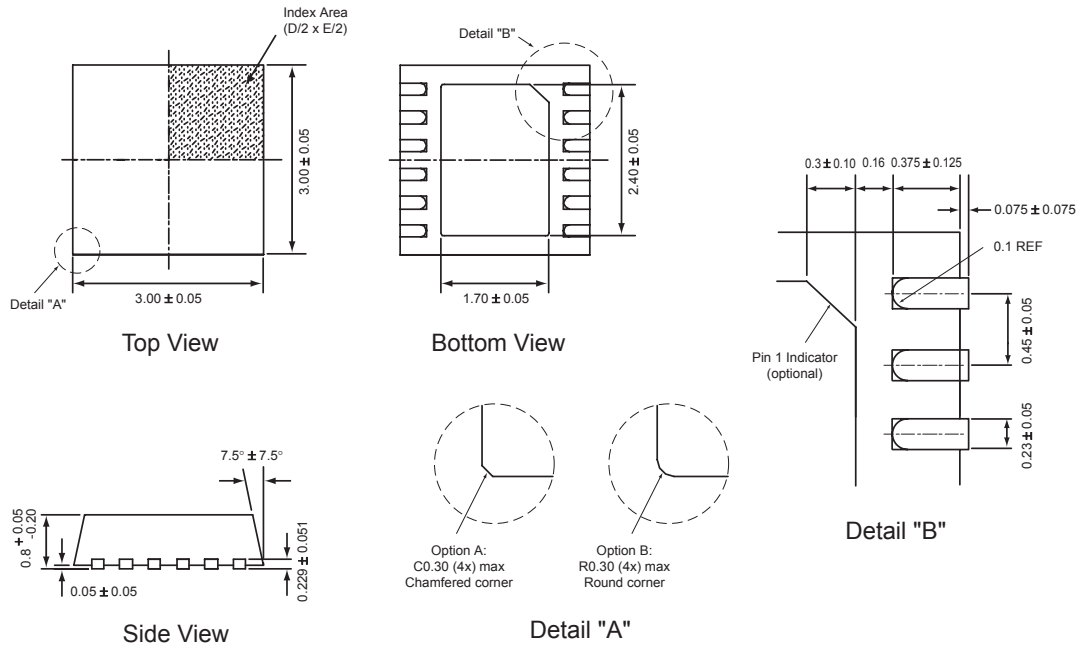

All dimensions in millimeters.

© Advanced Analogic Technologies, Inc.

AnalogicTech cannot assume responsibility for use of any circuitry other than circuitry entirely embodied in an AnalogicTech product. No circuit patent licenses, copyrights, mask work rights, or other intellectual property rights are implied. AnalogicTech reserves the right to make changes to their products or specifications or to discontinue any product or service without notice. Customers are advised to obtain the latest version of relevant information to verify, before placing orders, that information being relied on is current and complete. All products are sold subject to the terms and conditions of sale supplied at the time of order acknowledgement, including those pertaining to warranty, patent infringement, and limitation of liability. AnalogicTech warrants performance of its semiconductor products to the specifications applicable at the time of sale in accordance with AnalogicTech's standard warranty. Testing and other quality control techniques are utilized to the extent AnalogicTech deems necessary to support this warranty. Specific testing of all parameters of each device is not necessarily performed.

AnalogicTech and the AnalogicTech logo are trademarks of Advanced Analogic Technologies Incorporated. All other brand and product names appearing in this document are registered trademarks or trademarks of their respective holders.

Advanced Analogic Technologies, Inc.
 830 E. Arques Avenue, Sunnyvale, CA 94085
 Phone (408) 737-4600
 Fax (408) 737-4611