

DMOS

500mA Low-Dropout Regulator

FEATURES

- **NEW DMOS TOPOLOGY:**
Ultra Low Dropout Voltage:
115mV Typ at 500mA and 3.3V Output
Output Capacitor NOT Required for Stability
- **FAST TRANSIENT RESPONSE**
- **VERY LOW NOISE:** 33 μ Vrms
- **HIGH ACCURACY:** $\pm 2\%$ max
- **HIGH EFFICIENCY:**
 $I_{GND} = 1\text{mA}$ at $I_{OUT} = 500\text{mA}$
Not Enabled: $I_{GND} = 0.5\mu\text{A}$
- **2.5V, 2.7V, 3.0V, 3.3V, 5.0V, AND ADJUSTABLE OUTPUT VERSIONS**
- **FOLDBACK CURRENT LIMIT**
- **THERMAL PROTECTION**
- **OUTPUT VOLTAGE ERROR INDICATOR⁽¹⁾**
- **SMALL SURFACE-MOUNT PACKAGES:**
SOT223-5, DDPK-5, SO-8

APPLICATIONS

- **PORTABLE COMMUNICATION DEVICES**
- **BATTERY-POWERED EQUIPMENT**
- **PERSONAL DIGITAL ASSISTANTS**
- **MODEMS**
- **BAR-CODE SCANNERS**
- **BACKUP POWER SUPPLIES**

DESCRIPTION

The REG103 is a family of low-noise, low-dropout, linear regulators with low ground pin current. Its new DMOS topology provides significant improvement over previous designs, including low-dropout voltage (only 115mV typ at full load), and better transient performance. In addition, no output capacitor is required for stability, unlike conventional low-dropout regulators that are difficult to compensate and require expensive low ESR capacitors greater than 1 μ F.

Typical ground pin current is only 1mA (at $I_{OUT} = 500\text{mA}$) and drops to 0.5 μA in *not enabled* mode. Unlike regulators with PNP pass devices, quiescent current remains relatively constant over load variations and under dropout conditions.

The REG103 has very low output noise (typically 33 μVrms for $V_{OUT} = 3.3\text{V}$ with $C_{NR} = 0.01\mu\text{F}$), making it ideal for use in portable communications equipment. On-chip trimming results in high output voltage accuracy. Accuracy is maintained over temperature, line, and load variations. Key parameters are tested over the specified temperature range (-40°C to $+85^{\circ}\text{C}$).

The SO-8 version of the REG103 has an $\overline{\text{ERROR}}$ pin that provides a *power good* flag, indicating the regulator is in regulation. The REG103 is well protected—internal circuitry provides a current limit that protects the load from damage. Thermal protection circuitry keeps the chip from being damaged by excessive temperature. In addition to the SO-8 package, the REG103 is also available in the DDPK and the SOT223-5.

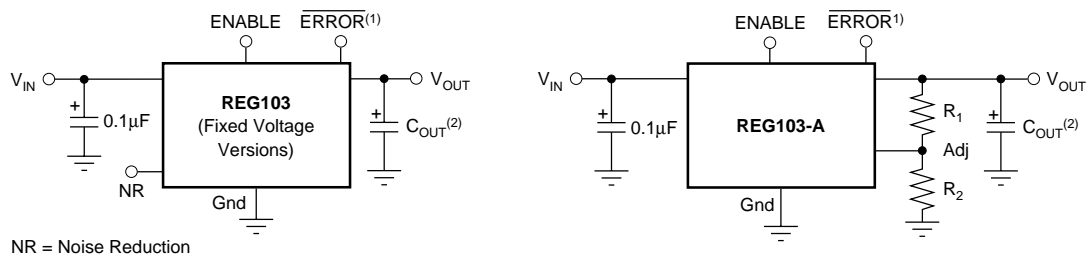

NOTE: (1) SO-8 Package Only. (2) Optional.



Please be aware that an important notice concerning availability, standard warranty, and use in critical applications of Texas Instruments semiconductor products and disclaimers thereto appears at the end of this data sheet.

All trademarks are the property of their respective owners.

PRODUCTION DATA information is current as of publication date. Products conform to specifications per the terms of Texas Instruments standard warranty. Production processing does not necessarily include testing of all parameters.

ABSOLUTE MAXIMUM RATINGS⁽¹⁾

Supply Input Voltage, V_{IN}	-0.3V to 16V
Enable Input	-0.3V to V_{IN}
Error Flag Output	-0.3V to 6V
Error Flag Current	2mA
Output Short-Circuit Duration	Indefinite
Operating Temperature Range	-55°C to +125°C
Storage Temperature Range	-65°C to +150°C
Junction Temperature	-55°C to +150°C
Lead Temperature (soldering, 3s, SO-8, SOT, and DDPAK)	+240°C

NOTE: (1) Stresses above these ratings may cause permanent damage. Exposure to absolute maximum conditions for extended periods may degrade device reliability.



ELECTROSTATIC DISCHARGE SENSITIVITY

This integrated circuit can be damaged by ESD. Texas Instruments recommends that all integrated circuits be handled with appropriate precautions. Failure to observe proper handling and installation procedures can cause damage.

ESD damage can range from subtle performance degradation to complete device failure. Precision integrated circuits may be more susceptible to damage because very small parametric changes could cause the device not to meet its published specifications.

PACKAGE/ORDERING INFORMATION⁽¹⁾

PRODUCT	PACKAGE-LEAD	PACKAGE DESIGNATOR	SPECIFIED TEMPERATURE RANGE	PACKAGE MARKING	ORDERING NUMBER	TRANSPORT MEDIA, QUANTITY
5V Output						
REG103FA-5	DDPAK-5	KTT	-40°C to +85°C	REG103FA-5.0	REG103FA-5KTTT	Tape and Reel, 50
"	"	"	"	"	REG103FA-5/500	Tape and Reel, 500
REG103UA-5	SO-8	D	-40°C to +85°C	REG103U50	REG103UA-5	Rails, 100
"	"	"	"	"	REG103UA-5/2K5	Tape and Reel, 2500
REG103GA-5	SOT223-5	DCQ	-40°C to +85°C	R103G50	REG103GA-5	Rails, 78
"	"	"	"	"	REG103GA-5/2K5	Tape and Reel, 2500
3.3V Output						
REG103FA-3.3	DDPAK-5	KTT	-40°C to +85°C	REG103FA-3.3	REG103FA-3.3KTTT	Tape and Reel, 50
"	"	"	"	"	REG103FA-3.3/500	Tape and Reel, 500
REG103UA-3.3	SO-8	D	-40°C to +85°C	REG103UA4	REG103UA-3.3	Rails, 100
"	"	"	"	"	REG103UA-3.3/2K5	Tape and Reel, 2500
REG103GA-3.3	SOT223-5	DCQ	-40°C to +85°C	R103G33	REG103GA-3.3	Rails, 78
"	"	"	"	"	REG103GA-3.3/2K5	Tape and Reel, 2500
3.0V Output						
REG103FA-3	DDPAK-5	KTT	-40°C to +85°C	REG103FA-3.0	REG103FA-3KTTT	Tape and Reel, 50
"	"	"	"	"	REG103FA-3/500	Tape and Reel, 500
REG103UA-3	SO-8	D	-40°C to +85°C	REG103U30	REG103UA-3	Rails, 100
"	"	"	"	"	REG103UA-3/2K5	Tape and Reel, 2500
REG103GA-3	SOT223-5	DCQ	-40°C to +85°C	R103G30	REG103GA-3	Rails, 78
"	"	"	"	"	REG103GA-3/2K5	Tape and Reel, 2500
2.7V Output						
REG103FA-2.7	DDPAK-5	KTT	-40°C to +85°C	REG103FA-2.7	REG103FA-2.7KTTT	Tape and Reel, 50
"	"	"	"	"	REG103FA-2.7/500	Tape and Reel, 500
REG103UA-2.7	SO-8	D	-40°C to +85°C	REG103U27	REG103UA-2.7	Rails, 100
"	"	"	"	"	REG103UA-2.7/2K5	Tape and Reel, 2500
REG103GA-2.7	SOT223-5	DCQ	-40°C to +85°C	R103G27	REG103GA-2.7	Rails, 78
"	"	"	"	"	REG103GA-2.7/2K5	Tape and Reel, 2500
2.5V Output						
REG103FA-2.5	DDPAK-5	KTT	-40°C to +85°C	REG103FA-2.5	REG103FA-2.5KTTT	Tape and Reel, 50
"	"	"	"	"	REG103FA-2.5/500	Tape and Reel, 500
REG103UA-2.5	SO-8	D	-40°C to +85°C	REG103U25	REG103UA-2.5	Rails, 100
"	"	"	"	"	REG103UA-2.5/2K5	Tape and Reel, 2500
REG103GA-2.5	SOT223-5	DCQ	-40°C to +85°C	R103G25	REG103GA-2.5	Rails, 78
"	"	"	"	"	REG103GA-2.5/2K5	Tape and Reel, 2500
Adjustable Output						
REG103FA-A	DDPAK-5	KTT	-40°C to +85°C	REG103FA-A	REG103FA-AKTTT	Tape and Reel, 50
"	"	"	"	"	REG103FA-A/500	Tape and Reel, 500
REG103UA-A	SO-8	D	-40°C to +85°C	REG103UA	REG103UA-A	Rails, 100
"	"	"	"	"	REG103UA-A/2K5	Tape and Reel, 2500
REG103GA-A	SOT223-5	DCQ	-40°C to +85°C	R103GA	REG103GA-A	Rails, 78
"	"	"	"	"	REG103GA-A/2K5	Tape and Reel, 2500

NOTE: (1) For the most current package and ordering information, refer to our web site at www.ti.com.

ELECTRICAL CHARACTERISTICS

Boldface limits apply over the specified temperature range, $T_J = -40^{\circ}\text{C}$ to $+85^{\circ}\text{C}$.

At $T_J = +25^{\circ}\text{C}$, $V_{IN} = V_{OUT} + 1\text{V}$ ($V_{OUT} = 3.0\text{V}$ for REG103-A), $V_{ENABLE} = 2\text{V}$, $I_{OUT} = 10\text{mA}$, $C_{NR} = 0.01\mu\text{F}$, and $C_{OUT} = 0.1\mu\text{F}^{(1)}$, unless otherwise noted.

PARAMETER	CONDITION	REG103GA, UA, FA			UNITS
		MIN	TYP	MAX	
OUTPUT VOLTAGE					
Output Voltage Range	V_{OUT}				V
REG103-2.5			2.5		V
REG103-2.7			2.7		V
REG103-3.0			3.0		V
REG103-3.3			3.3		V
REG103-5			5		V
REG103-A					V
Reference Voltage	V_{REF}		1.295	5.5	V
Adjust Pin Current	I_{ADJ}		0.2	1	μA
Accuracy			± 0.5	± 2	%
$T_J = -40^{\circ}\text{C}$ to $+85^{\circ}\text{C}$				± 2.8	%
vs Temperature	dV_{OUT}/dT	$T_J = -40^{\circ}\text{C}$ to $+85^{\circ}\text{C}$	70		ppm/ $^{\circ}\text{C}$
vs Line and Load		$I_{OUT} = 10\text{mA}$ to 500mA , $V_{IN} = (V_{OUT} + 0.7\text{V})$ to 15V	± 0.5	± 2.5	%
$T_J = -40^{\circ}\text{C}$ to $+85^{\circ}\text{C}$		$V_{IN} = (V_{OUT} + 0.9\text{V})$ to 15V		± 3.5	%
DC DROPOUT VOLTAGE^(2, 3)	V_{DROP}				
For all models except 5V		$I_{OUT} = 10\text{mA}$	3	25	mV
For 5V model		$I_{OUT} = 500\text{mA}$	115	200	mV
For all models except 5V		$I_{OUT} = 500\text{mA}$	160	250	mV
$T_J = -40^{\circ}\text{C}$ to $+85^{\circ}\text{C}$		$I_{OUT} = 500\text{mA}$		230	mV
For 5V models		$I_{OUT} = 500\text{mA}$		280	mV
$T_J = -40^{\circ}\text{C}$ to $+85^{\circ}\text{C}$					
VOLTAGE NOISE	V_n				
$f = 10\text{Hz}$ to 100kHz		$C_{NR} = 0$, $C_{OUT} = 0$			
Without C_{NR} (all models)		$C_{NR} = 0.01\mu\text{F}$, $C_{OUT} = 10\mu\text{F}$			
With C_{NR} (all fixed voltage models)				$30\mu\text{Vrms}/\text{V} \cdot V_{OUT}$	μVrms
				$10\mu\text{Vrms}/\text{V} \cdot V_{OUT}$	μVrms
OUTPUT CURRENT					
Current Limit ⁽⁴⁾	I_{CL}		550	700	950
$T_J = -40^{\circ}\text{C}$ to $+85^{\circ}\text{C}$			500		1000
					mA
					mA
RIPPLE REJECTION					
$f = 120\text{Hz}$				65	dB
ENABLE CONTROL					
V_{ENABLE} HIGH (output enabled)	V_{ENABLE}		2		V_{IN}
V_{ENABLE} LOW (output disabled)			-0.2		0.5
I_{ENABLE} HIGH (output enabled)	I_{ENABLE}	$V_{ENABLE} = 2\text{V}$ to V_{IN} , $V_{IN} = 2.1\text{V}$ to $6.5^{(5)}$		1	100
I_{ENABLE} LOW (output disabled)		$V_{ENABLE} = 0\text{V}$ to 0.5V		2	100
Output Disable Time				50	μs
Output Enable Soft Start Time				1.5	ms
ERROR FLAG⁽⁶⁾					
Current, Logic HIGH (open drain)—Normal Operation		$V_{IN} = V_{ERROR} = V_{OUT} + 1\text{V}$		0.1	10
Voltage, Logic LOW—On Error		Sinking $500\mu\text{A}$		0.2	0.4
					μA
					V
THERMAL SHUTDOWN					
Junction Temperature				150	$^{\circ}\text{C}$
Shutdown				130	$^{\circ}\text{C}$
Reset from Shutdown					
GROUND PIN CURRENT					
Ground Pin Current	I_{GND}	$I_{OUT} = 10\text{mA}$		0.5	0.7
		$I_{OUT} = 500\text{mA}$		1	1.3
ENABLE Pin LOW		$V_{ENABLE} \leq 0.5\text{V}$		0.5	μA
					mA
					mA
					μA
INPUT VOLTAGE	V_{IN}				
Operating Input Voltage Range ⁽⁷⁾		$V_{IN} > 2.7\text{V}$	2.1		15
Specified Input Voltage Range		$V_{IN} > 2.9\text{V}$	$V_{OUT} + 0.7$		15
$T_J = -40^{\circ}\text{C}$ to $+85^{\circ}\text{C}$			$V_{OUT} + 0.9$		15
					V
					V
					V
TEMPERATURE RANGE					
Specified Range	T_J		-40		+85
Operating Range			-55		+125
Storage Range			-65		+150
					$^{\circ}\text{C}$
Thermal Resistance					
DDPAK-5 Surface-Mount	θ_{JC}	Junction-to-Case		4	$^{\circ}\text{C}/\text{W}$
SO-8 Surface-Mount	θ_{JA}	Junction-to-Ambient		150	$^{\circ}\text{C}/\text{W}$
SOT223-5 Surface-Mount	θ_{JC}	Junction-to-Case		15	$^{\circ}\text{C}/\text{W}$

NOTES: (1) The REG103 does not require a minimum output capacitor for stability. However, transient response can be improved with proper capacitor selection. (2) Dropout voltage is defined as the input voltage minus the output voltage that produces a 2% change in the output voltage from the value at $V_{IN} = V_{OUT} + 1\text{V}$ at fixed load. (3) Not applicable for V_{OUT} less than 2.7V. (4) Current limit is the output current that produces a 10% change in output voltage from $V_{IN} = V_{OUT} + 1\text{V}$ and $I_{OUT} = 10\text{mA}$. (5) For $V_{IN} > 6.5\text{V}$, see typical characteristic " V_{ENABLE} vs I_{ENABLE} ." (6) Logic low indicates out-of-regulation condition by approximately 10%, or thermal shutdown. (7) The REG103 no longer regulates when $V_{IN} < V_{OUT} + V_{DROP(MAX)}$. In drop-out or when the input voltage is between 2.7V and 2.1V, the impedance from V_{IN} to V_{OUT} is typically less than 1Ω at $T_J = +25^{\circ}\text{C}$. See typical characteristic.

PIN CONFIGURATIONS

Top View

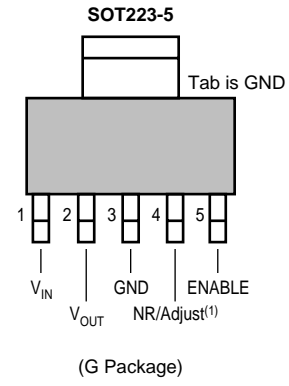
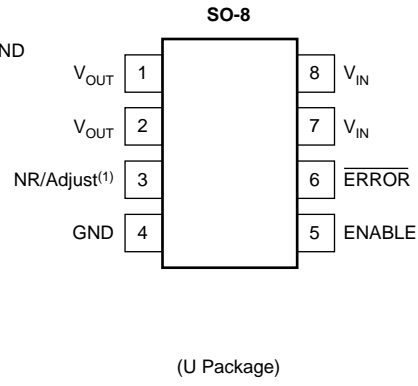
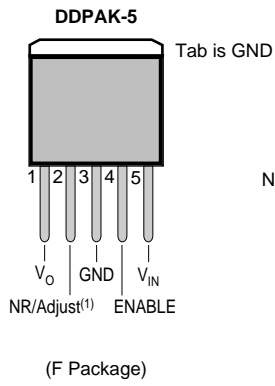

NOTE: (1) For REG103A-A: voltage setting resistor pin.
All other models: noise reduction capacitor pin.

TYPICAL CHARACTERISTICS

For all models, at $T_J = +25^\circ\text{C}$ and $V_{\text{ENABLE}} = 2\text{V}$, unless otherwise noted.

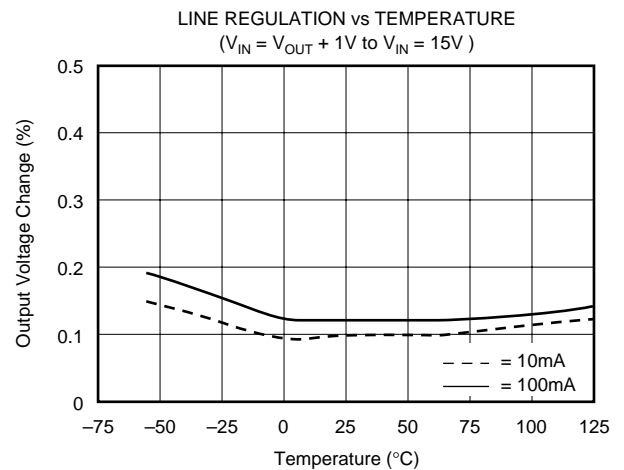
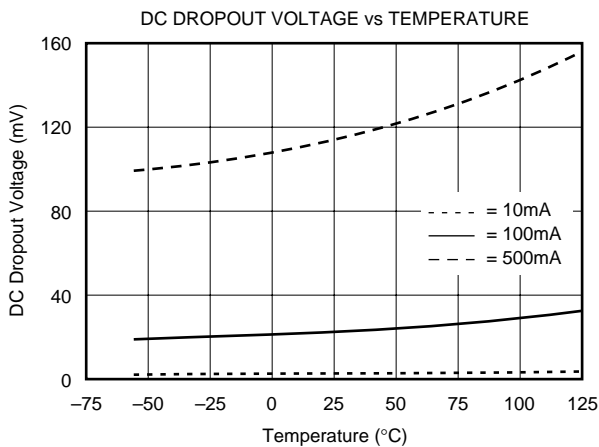
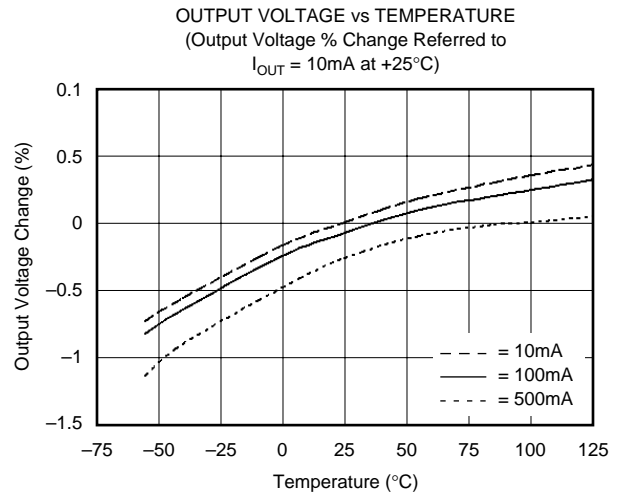
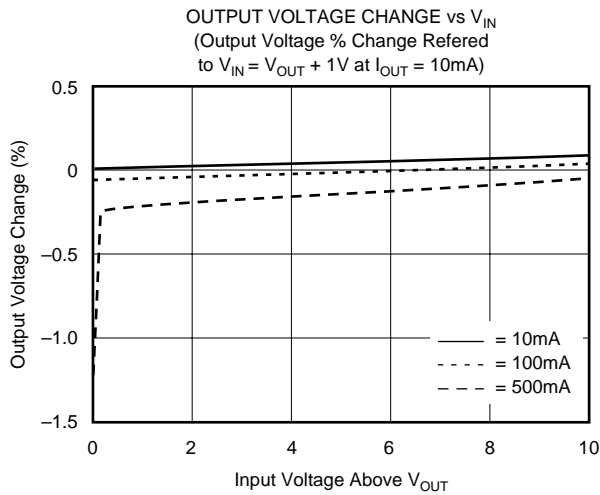
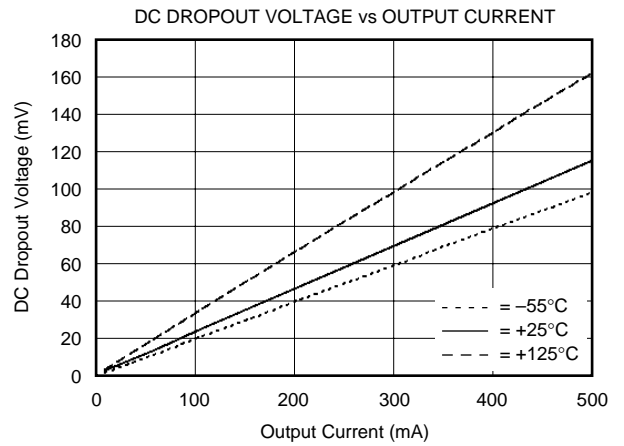
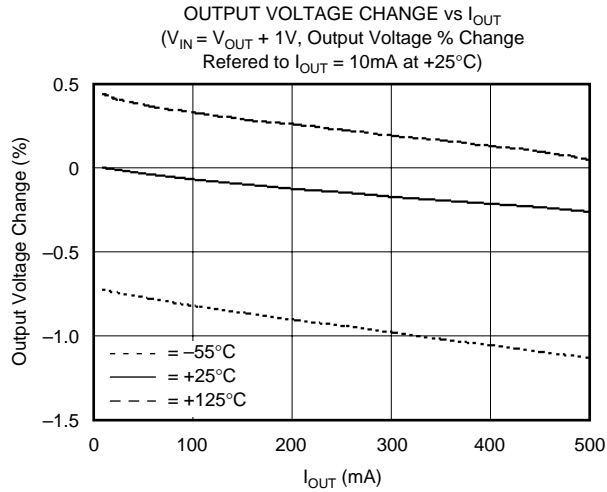

TYPICAL CHARACTERISTICS (Cont.)

For all models, at $T_J = +25^\circ\text{C}$ and $V_{\text{ENABLE}} = 2\text{V}$, unless otherwise noted.

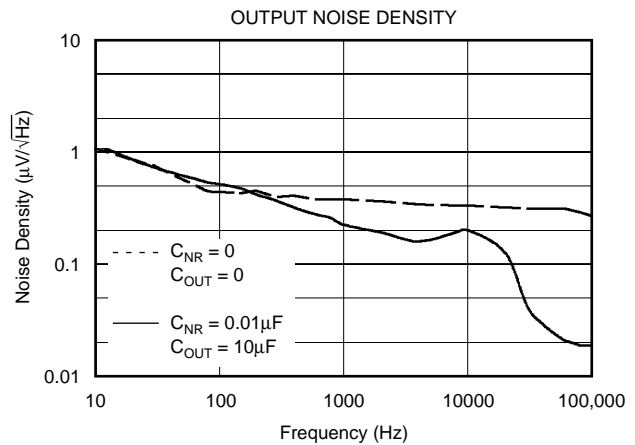
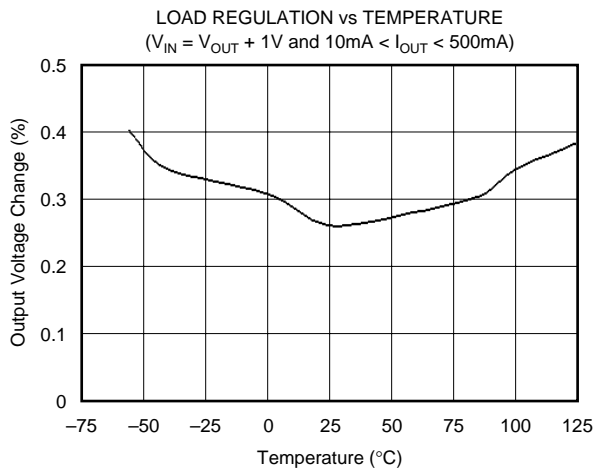
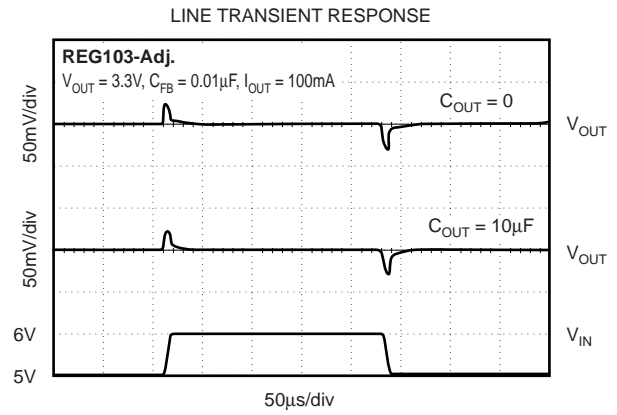
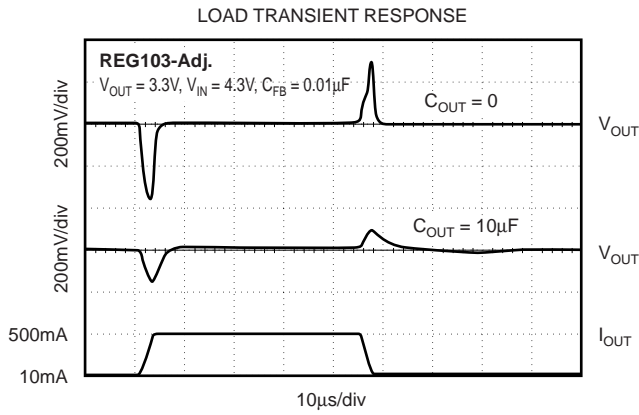
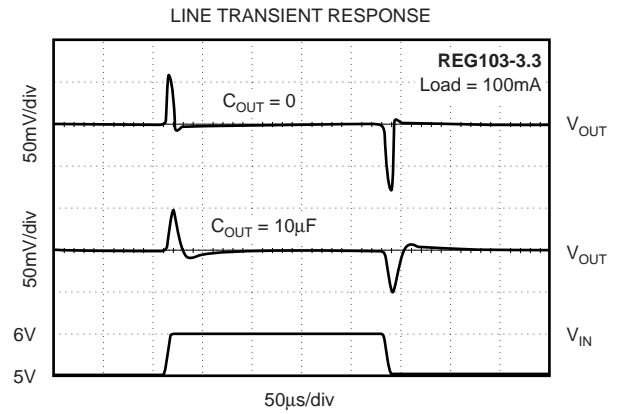
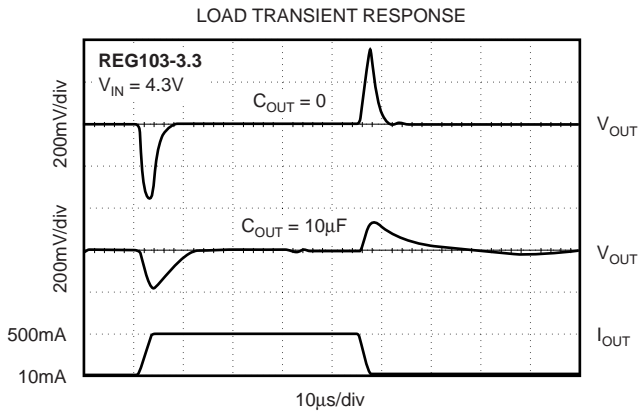

TYPICAL CHARACTERISTICS (Cont.)

For all models, at $T_J = +25^\circ\text{C}$ and $V_{\text{ENABLE}} = 2\text{V}$, unless otherwise noted.

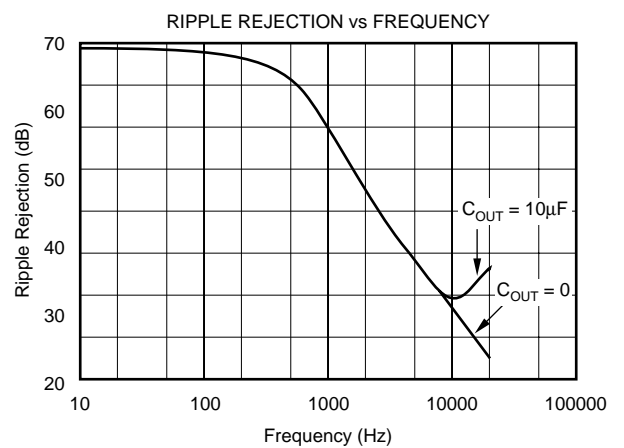
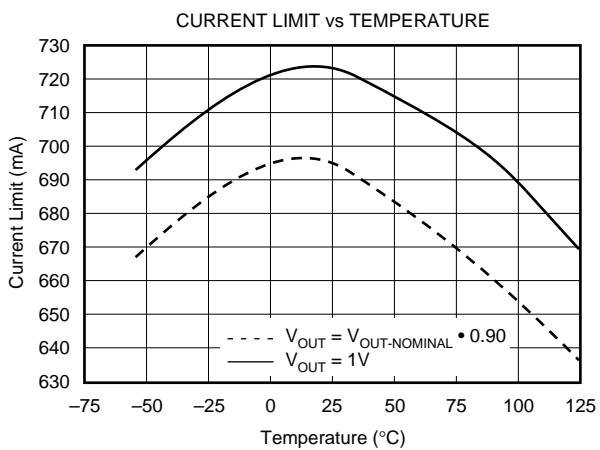
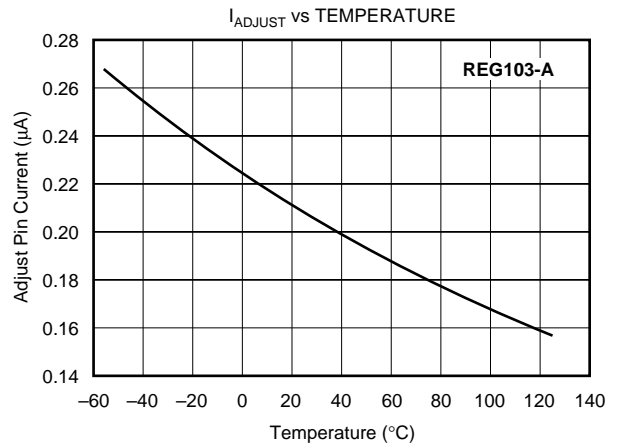
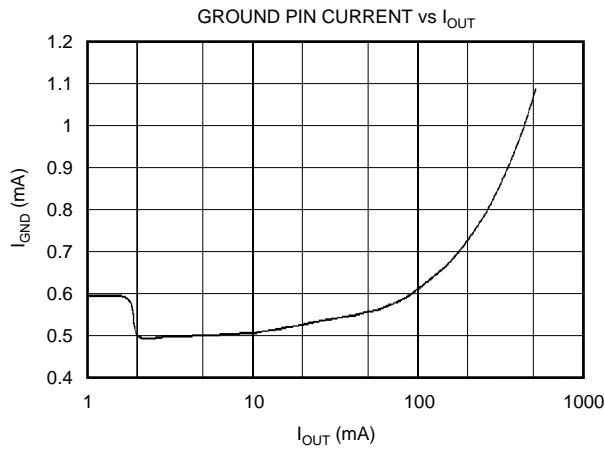
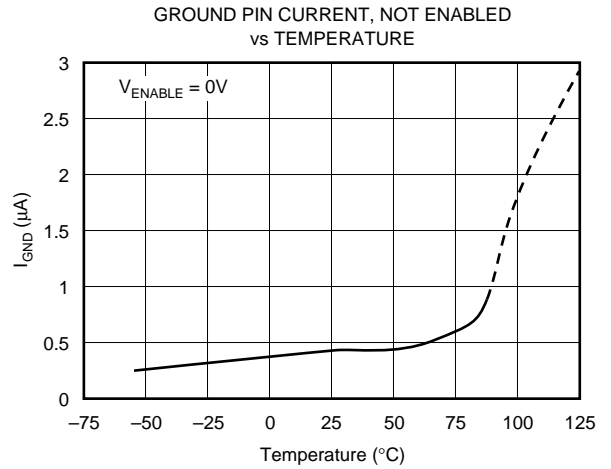
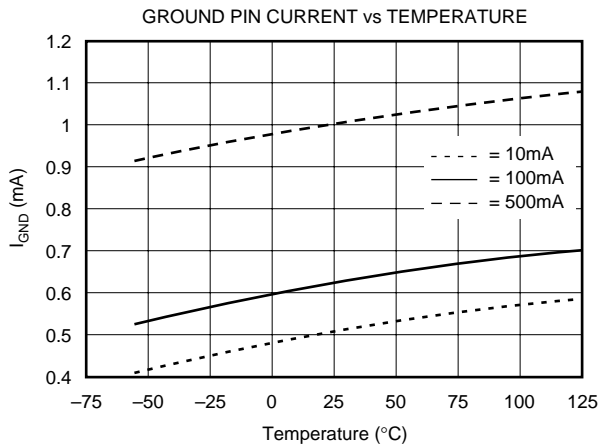

TYPICAL CHARACTERISTICS (Cont.)

For all models, at $T_J = +25^\circ\text{C}$ and $V_{\text{ENABLE}} = 2\text{V}$, unless otherwise noted.

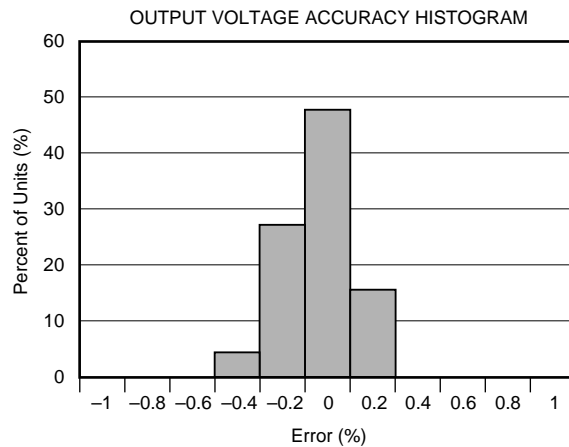
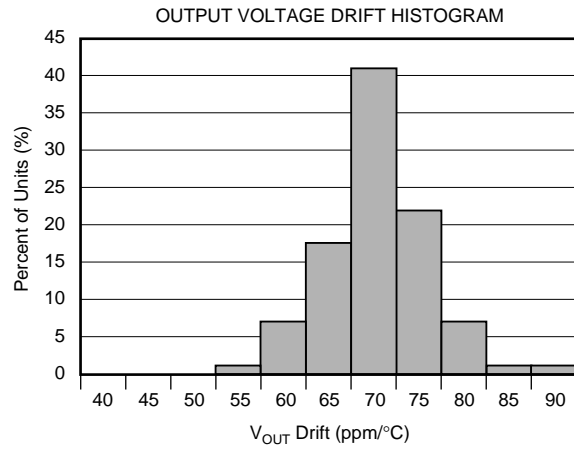
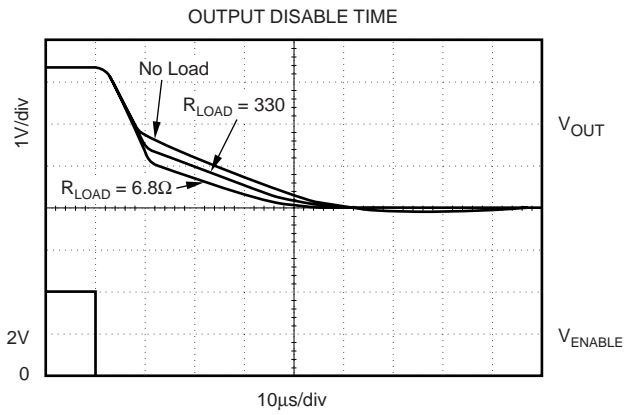
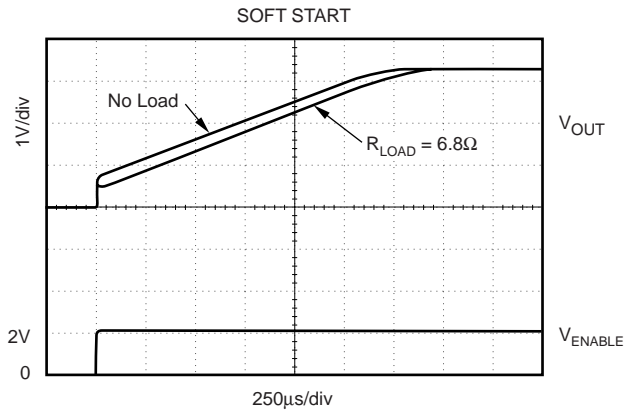
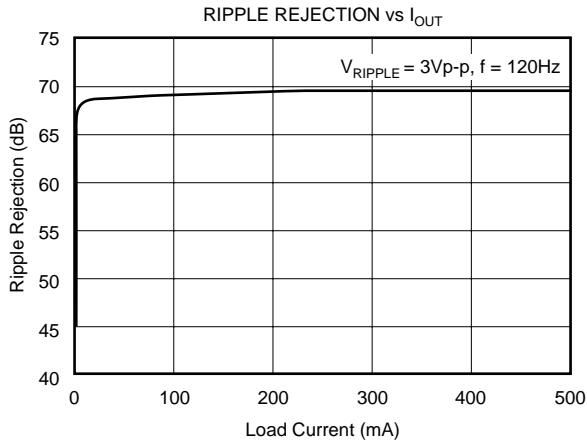

BASIC OPERATION

The REG103 series is a family of LDO (Low Drop-Out) linear regulators. The family includes five fixed output versions (2.5V to 5.0V) and an adjustable output version. An internal DMOS power device provides low dropout regulation with near constant ground pin current (largely independent of load and drop-out conditions) and very fast line and load transient response. All versions include internal current limit and thermal shutdown circuitry.

Figure 1 shows the basic circuit connections for the fixed voltage models. Figure 2 gives the connections for the adjustable output version (REG103A) and example resistor values for some commonly used output voltages. Values for other voltages can be calculated from the equation shown in Figure 2. The SO-8 package provides two pins each for V_{IN} and V_{OUT} . Both sets of pins **MUST** be used and connected adjacent to the device.

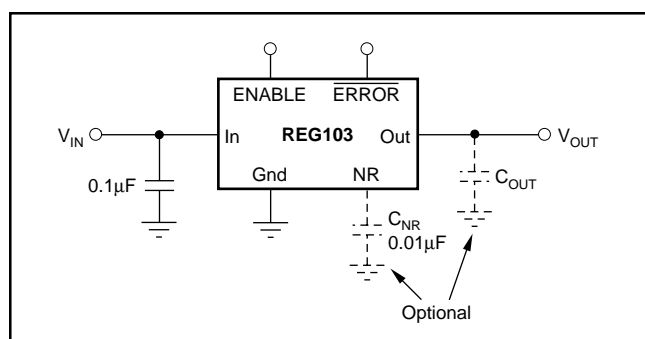

FIGURE 1. Fixed Voltage Nominal Circuit for REG103.

None of the versions require an output capacitor for regulator stability. The REG103 will accept any output capacitor type less than 1µF. For capacitance values larger than 1µF, the effective ESR should be greater than 0.1Ω. This minimum ESR value includes parasitics such as printed circuit board traces, solder joints, and sockets. A minimum 0.1µF low ESR capacitor connected to the input supply voltage is recommended.

INTERNAL CURRENT LIMIT

The REG103 internal current limit has a typical value of 700mA. A fold-back feature limits the short-circuit current to a typical short-circuit value of 40mA. This circuit will protect the regulator from damage under all load conditions. A typical characteristic of V_{OUT} versus I_{OUT} is given in Figure 3a.

Care should be taken in high current applications to avoid ground currents flowing in the circuit board traces causing voltage drops between points on the circuit. If voltage drops occur on the circuit board ground that causes the load ground voltage to be much lower than the ground voltage seen by the ground pin on the REG103, the foldback current may approach zero and the REG103 may not start up. In these types of applications, a large value resistor can be placed between V_{IN} and V_{OUT} to help “boost” up the output of the REG103 during start-up, see Figure 3b. The value for the “boost” resistor should be chosen so that the current through the “boost” resistor is less than the minimum load current: $R_{BOOST} > (V_{IN} - V_{OUT})/I_{LOAD}$. Typically, a good value for a “boost” resistor is 5kΩ.

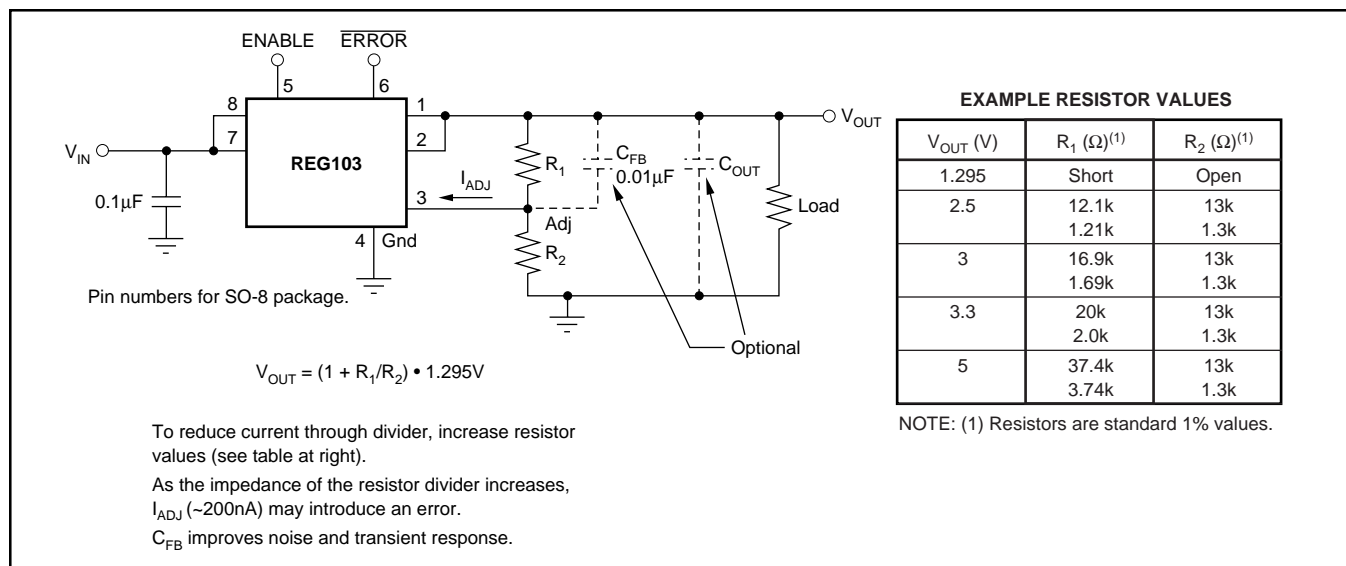

FIGURE 2. Adjustable Voltage Circuit for REG103A.

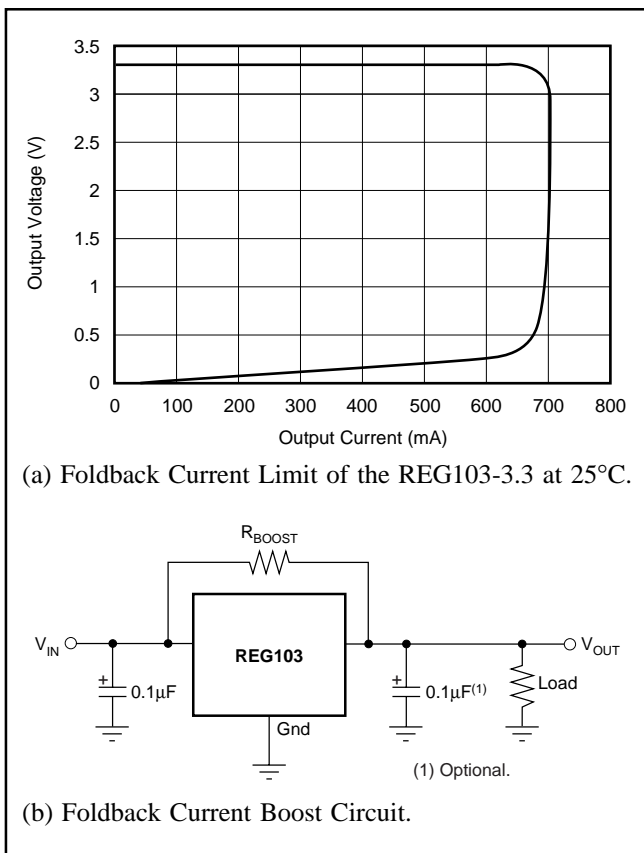

FIGURE 3. Foldback Current Limit and Boost Circuit.

ENABLE

The ENABLE pin allows the regulator to be turned on and off. This pin is active HIGH and compatible with standard TTL-CMOS levels. Inputs below 0.5V (max) turn the regulator off and all circuitry is disabled. Under this condition, ground pin current drops to approximately 0.5μA. When not used, the ENABLE pin may be connected to V_{IN}.

Internal to the part, the ENABLE pin is connected to an input resistor-zener diode circuit, as shown in Figure 4, creating a nonlinear input impedance. The ENABLE Pin Current versus Applied Voltage relationship is shown in Figure 5. When the ENABLE pin is connected to a voltage greater than 10V, a series resistor may be used to limit the current.

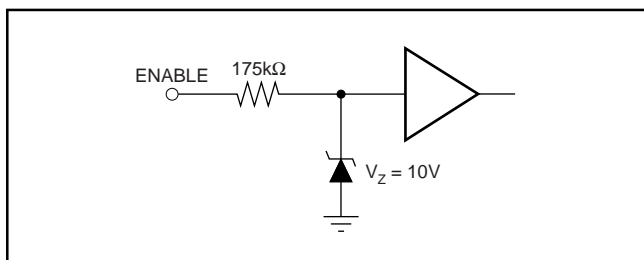

FIGURE 4. ENABLE Pin Equivalent Input Circuit.

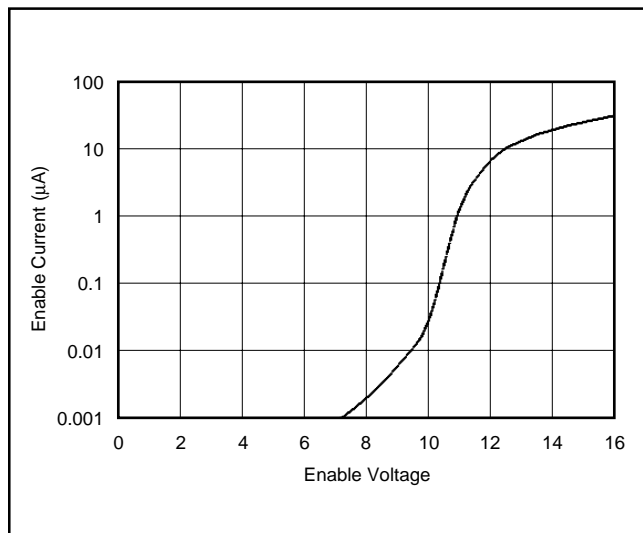

FIGURE 5. ENABLE Pin Current versus Applied Voltage.

ERROR FLAG

The error indication pin, only available on the SO-8 package version, provides a fault indication out-of-regulation condition. During a fault condition, $\overline{\text{ERROR}}$ is pulled LOW by an open drain output device. The pin voltage, in the fault state, is typically less than 0.2V at 500μA.

A fault condition is indicated when the output voltage differs (either above or below) from the specified value by approximately 10%. Figure 6 shows a typical fault-monitoring application.

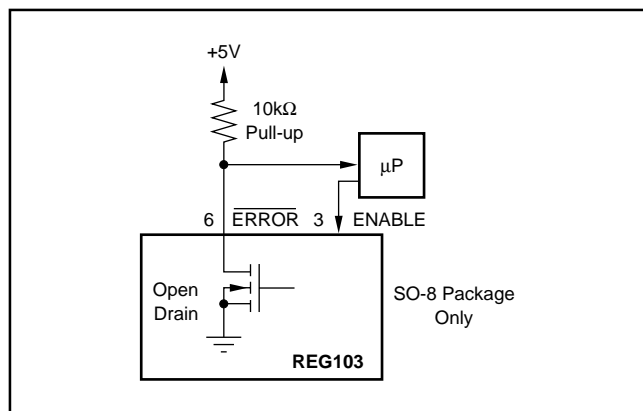

FIGURE 6. $\overline{\text{ERROR}}$ Pin Typical Fault-Monitoring Circuit.

OUTPUT NOISE

A precision band-gap reference is used for the internal reference voltage, V_{REF}, for the REG103. This reference is the dominant noise source within the REG103. It generates approximately 45μV_{rms} in the 10Hz to 100kHz bandwidth at the reference output. The regulator control loop gains up the reference noise, so that the noise voltage of the regulator is approximately given by:

$$V_N = 45\mu\text{V}_{\text{rms}} \frac{R_1 + R_2}{R_2} = 45\mu\text{V}_{\text{rms}} \cdot \frac{V_{\text{OUT}}}{V_{\text{REF}}}$$

Since the value of V_{REF} is 1.295V, this relationship reduces to:

$$V_N = 35 \frac{\mu V_{rms}}{V} \bullet V_{OUT}$$

Connecting a capacitor, C_{NR} , from the Noise-Reduction (NR) pin to ground, can reduce the output noise voltage. Adding C_{NR} , as shown in Figure 7, forms a low-pass filter for the voltage reference. For $C_{NR} = 10nF$, the total noise in the 10Hz to 100kHz bandwidth is reduced by approximately a factor of 3.5, as shown in Figure 8.

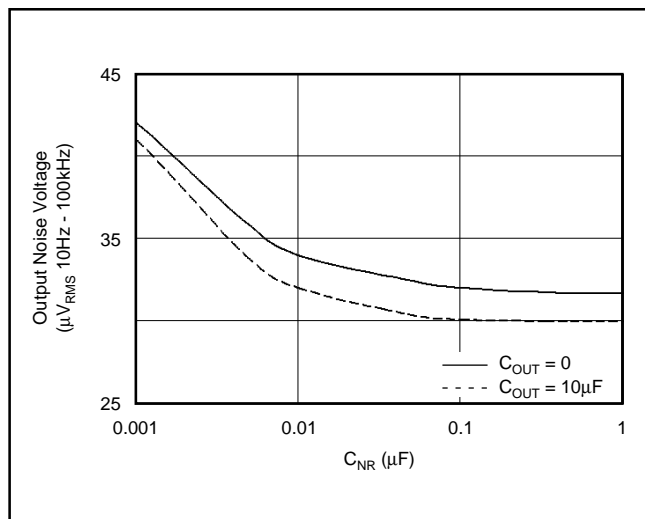

FIGURE 8. Output Noise versus Noise-Reduction Capacitor.

The REG103 adjustable version does not have the noise-reduction pin available, however, the adjust pin is the summing junction of the error amplifier. A capacitor, C_{FB} , connected from the output to the adjust pin will reduce both the output noise and the peak error from a load transient. Figure 9 shows improved output noise performance for two capacitor combinations.

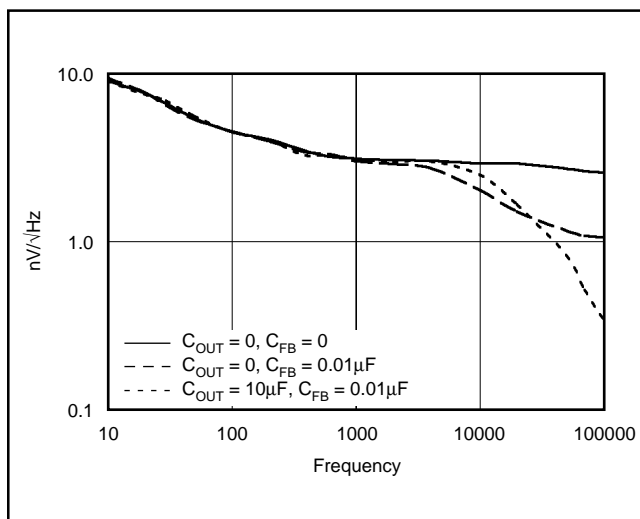

FIGURE 9. Output Noise Density on Adjustable Versions.

The REG103 utilizes an internal charge pump to develop an internal supply voltage sufficient to drive the gate of the DMOS pass element above V_{IN} . The charge-pump switching noise (nominal switching frequency = 2MHz) is not measurable at the output of the regulator.

DROP-OUT VOLTAGE

The REG103 uses an N-channel DMOS as the “pass” element. When the input voltage is within a few hundred millivolts of the output voltage, the DMOS device behaves like a resistor. Therefore, for low values of V_{IN} to V_{OUT} , the regulator’s input-to-output resistance is the $R_{DS(ON)}$ of the DMOS pass element (typically 230mΩ). For static (DC) loads, the REG103 will typically maintain regulation down to V_{IN} to V_{OUT} voltage drop of 115mV at full-rated output current. In Figure 10, the bottom line (DC dropout) shows the minimum V_{IN} to V_{OUT} voltage drop required to prevent drop-out under DC load conditions.

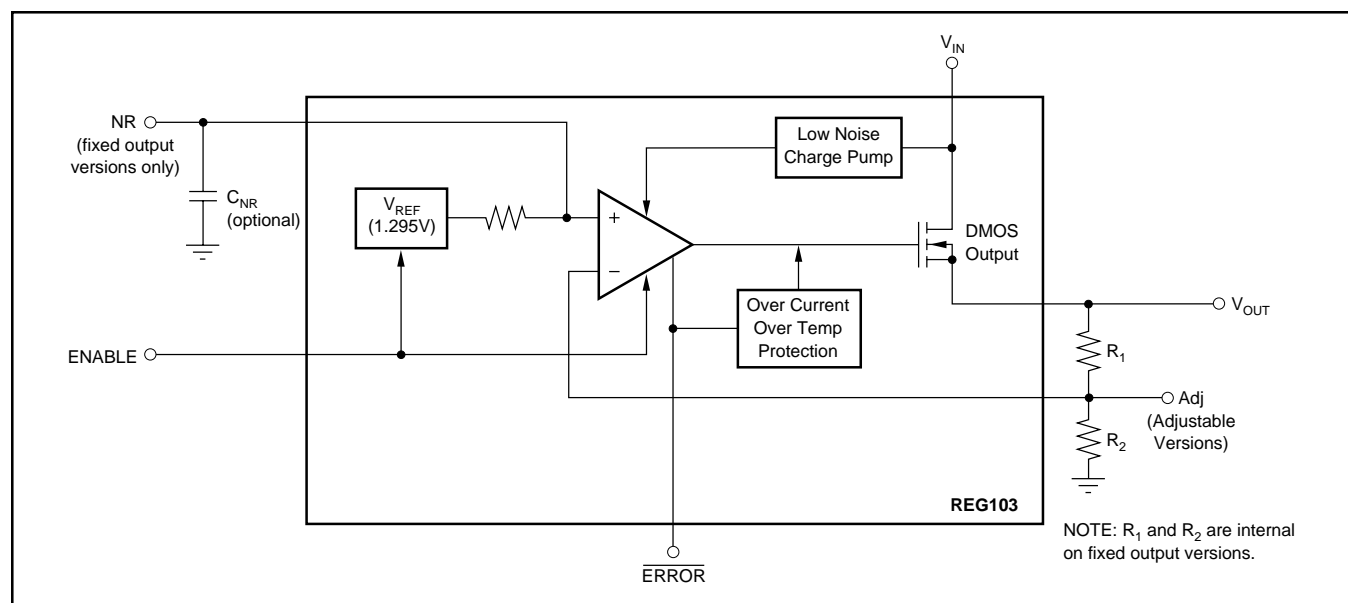

FIGURE 7. Block Diagram.

For large step changes in load current, the REG103 requires a larger voltage drop across it to avoid degraded transient response. The boundary of this “transient drop-out” region is shown as the top line in Figure 10. Values of V_{IN} to V_{OUT} voltage drop above this line insure normal transient response.

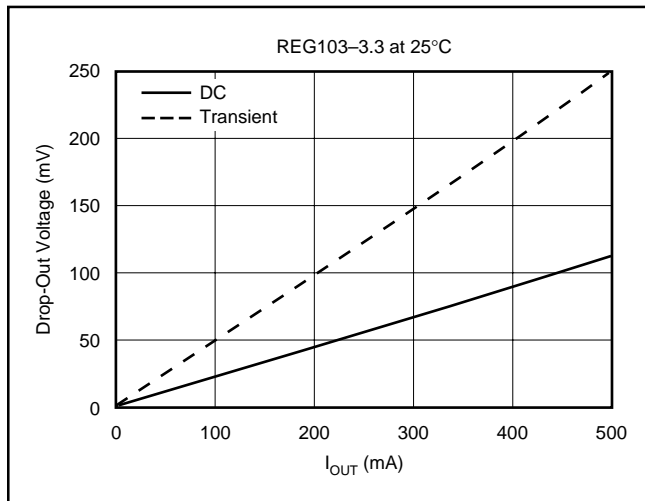

FIGURE 10. Transient and DC Dropout.

In the transient dropout region between “DC” and “Transient”, transient response recovery time increases. The time required to recover from a load transient is a function of both the magnitude and rate of the step change in load current and the available “headroom” V_{IN} to V_{OUT} voltage drop. Under worst-case conditions (full-scale load change with V_{IN} to V_{OUT} voltage drop close to DC dropout levels), the REG103 can take several hundred microseconds to re-enter the specified window of regulation.

TRANSIENT RESPONSE

The REG103 response to transient line and load conditions improves at lower output voltages. The addition of a capacitor (nominal value 10nF) from the output pin to ground may improve the transient response. In the adjustable version, the addition of a capacitor, C_{FB} (nominal value 10nF), from the output to the adjust pin will also improve the transient response.

THERMAL PROTECTION

Power dissipated within the REG103 will cause the junction temperature to rise. The REG103 has thermal shutdown circuitry that protects the regulator from damage. The thermal protection circuitry disables the output when the junction temperature reaches approximately 150°C, allowing the device to cool. When the junction temperature cools to approximately 130°C, the output circuitry is again enabled. Depending on various conditions, the thermal protection circuit may cycle on and off. This limits the dissipation of the regulator, but may have an undesirable effect on the load.

Any tendency to activate the thermal protection circuit indicates excessive power dissipation or an inadequate heat sink. For reliable operation, junction temperature should be

limited to 125°C, maximum. To estimate the margin of safety in a complete design (including heat sink), increase the ambient temperature until the thermal protection is triggered. Use worst-case loads and signal conditions. For good reliability, thermal protection should trigger more than 35°C above the maximum expected ambient condition of your application. This produces a worst-case junction temperature of 125°C at the highest expected ambient temperature and worst-case load.

The internal protection circuitry of the REG103 has been designed to protect against overload conditions. It was not intended to replace proper heat sinking. Continuously running the REG103 into thermal shutdown will degrade reliability.

POWER DISSIPATION

The REG103 is available in three different package configurations. The ability to remove heat from the die is different for each package type and, therefore, presents different considerations in the printed circuit-board layout. The PCB area around the device that is free of other components moves the heat from the device to the ambient air. While it is difficult-to-impossible to quantify all of the variables in a thermal design of this type, performance data for several configurations are shown in Figure 11. In all cases, the PCB copper area is bare copper, free of solder-resist mask, and not solder plated. All examples are for 1-ounce copper. Using heavier copper will increase the effectiveness in moving the heat from the device. In those examples where there is copper on both sides of the PCB, no connection has been provided between the two sides. The addition of plated through holes will improve the heat sink effectiveness.

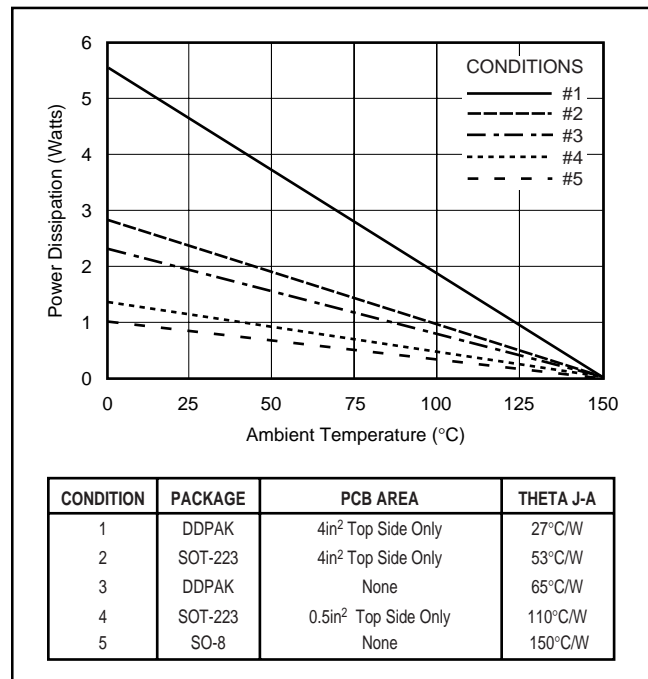

FIGURE 11. Maximum Power Dissipation versus Ambient Temperature for the Various Packages and PCB Heat Sink Configurations.

Power dissipation depends on input voltage and load conditions. Power dissipation is equal to the product of the average output current times the voltage across the output element, V_{IN} to V_{OUT} voltage drop.

$$P_D = (V_{IN} - V_{OUT}) \cdot I_{OUT(AVG)}$$

Power dissipation can be minimized by using the lowest possible input voltage necessary to assure the required output voltage.

REGULATOR MOUNTING

The tab of both packages is electrically connected to ground. For best thermal performance, the tab of the DDPAK surface-mount version should be soldered directly to a circuit-

board copper area. Increasing the copper area improves heat dissipation. Figure 12 shows typical thermal resistance from junction to ambient as a function of the copper area for the DDPAK.

Although the tabs of the DDPAK and the SOT-223 are electrically grounded, they are not intended to carry any current. The copper pad that acts as a heat sink should be isolated from the rest of the circuit to prevent current flow through the device from the tab to the ground pin. Solder pad footprint recommendations for the various REG103 devices are presented in the Application Bulletin “Solder Pad Recommendations for Surface-Mount Devices” (SBFA015), available from the Texas Instruments web site (www.ti.com).

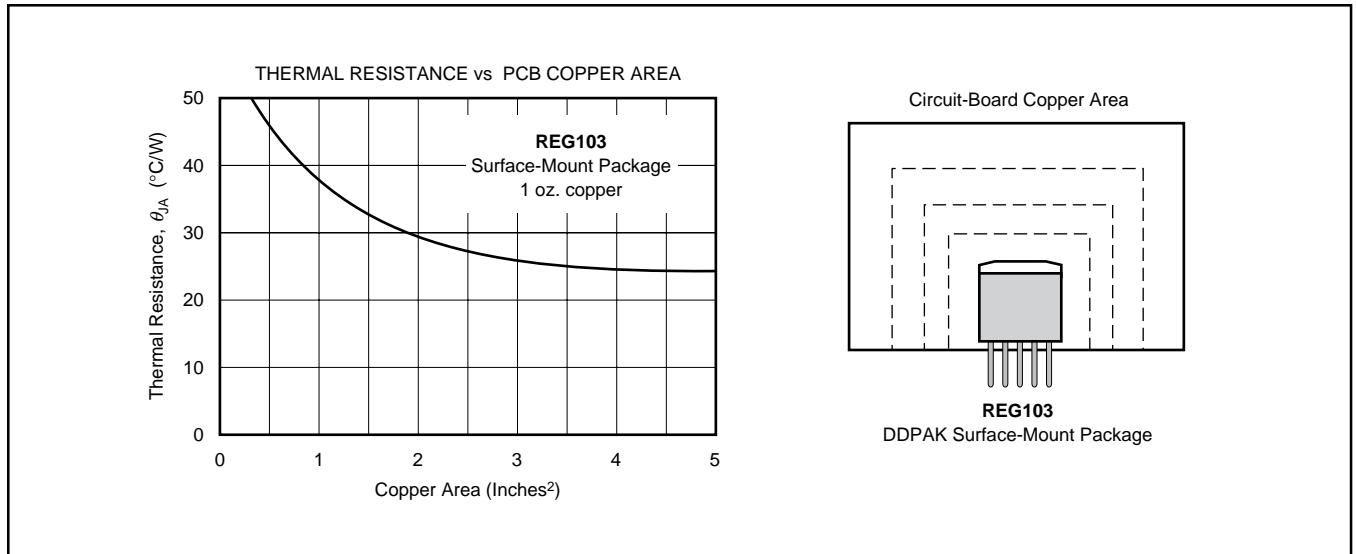

FIGURE 12. Thermal Resistance versus PCB Area for the Five-Lead DDPAK.

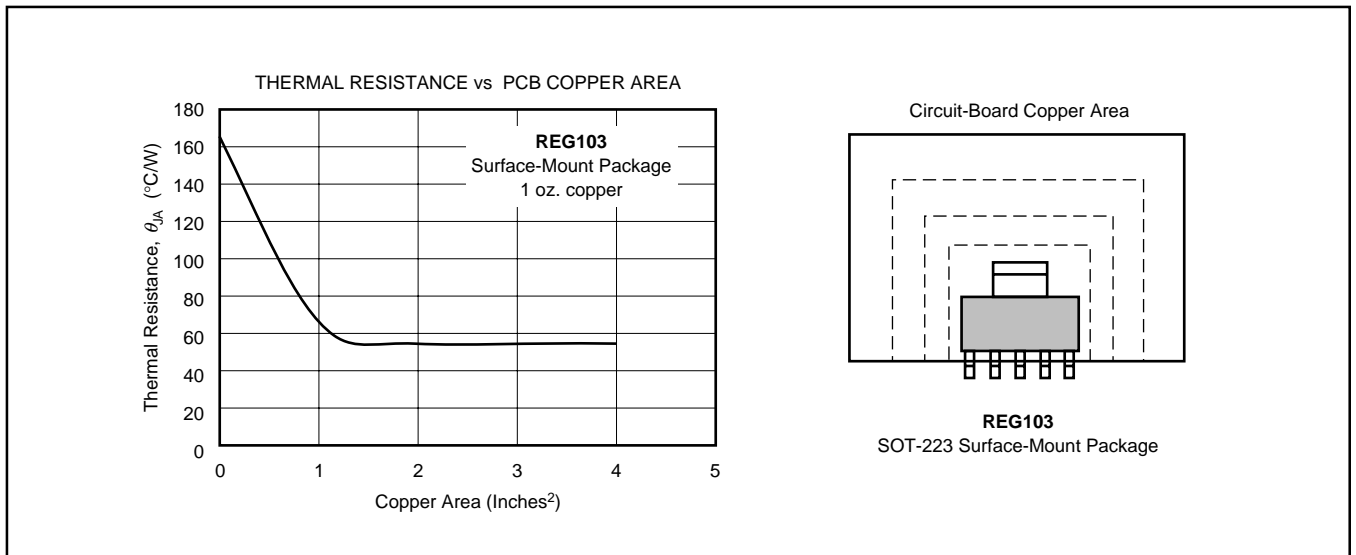

FIGURE 13. Thermal Resistance versus PCB Area for the Five-Lead SOT-223.

PACKAGING INFORMATION

Orderable Device	Status ⁽¹⁾	Package Type	Package Drawing	Pins	Package Qty	Eco Plan ⁽²⁾	Lead/Ball Finish	MSL Peak Temp ⁽³⁾
REG103FA-2.5	OBSOLETE	DDPAK/ TO-263	KTT	5		None	Call TI	Call TI
REG103FA-2.5/500	NRND	DDPAK/ TO-263	KTT	5	500	None	Call TI	Level-3-220C-168 HR
REG103FA-2.5KTTT	NRND	DDPAK/ TO-263	KTT	5	50	None	Call TI	Level-3-220C-168 HR
REG103FA-2.7	OBSOLETE	DDPAK/ TO-263	KTT	5		None	Call TI	Call TI
REG103FA-2.7/500	NRND	DDPAK/ TO-263	KTT	5	500	None	Call TI	Level-3-220C-168 HR
REG103FA-2.7KTTT	NRND	DDPAK/ TO-263	KTT	5	50	None	Call TI	Level-3-220C-168 HR
REG103FA-3	OBSOLETE	DDPAK/ TO-263	KTT	5		None	Call TI	Call TI
REG103FA-3.3	OBSOLETE	DDPAK/ TO-263	KTT	5		None	Call TI	Call TI
REG103FA-3.3/500	NRND	DDPAK/ TO-263	KTT	5	500	None	Call TI	Level-3-220C-168 HR
REG103FA-3.3KTTT	NRND	DDPAK/ TO-263	KTT	5	50	None	Call TI	Level-3-220C-168 HR
REG103FA-3/500	NRND	DDPAK/ TO-263	KTT	5	500	None	Call TI	Level-3-220C-168 HR
REG103FA-3KTTT	NRND	DDPAK/ TO-263	KTT	5	50	None	Call TI	Level-3-220C-168 HR
REG103FA-5	OBSOLETE	DDPAK/ TO-263	KTT	5		None	Call TI	Call TI
REG103FA-5/500	NRND	DDPAK/ TO-263	KTT	5	500	None	Call TI	Level-3-220C-168 HR
REG103FA-5KTTT	NRND	DDPAK/ TO-263	KTT	5	50	None	Call TI	Level-3-220C-168 HR
REG103FA-A	OBSOLETE	DDPAK/ TO-263	KTT	5		None	Call TI	Call TI
REG103FA-A/500	NRND	DDPAK/ TO-263	KTT	5	500	None	Call TI	Level-3-220C-168 HR
REG103FA-AKTTT	NRND	DDPAK/ TO-263	KTT	5	50	None	Call TI	Level-3-220C-168 HR
REG103GA-2.5	NRND	SOP	DCQ	6	78	None	Call TI	Level-3-240C-168 HR
REG103GA-2.5/2K5	NRND	SOP	DCQ	6	2500	None	Call TI	Level-3-240C-168 HR
REG103GA-2.7	NRND	SOP	DCQ	6	78	None	Call TI	Level-3-240C-168 HR
REG103GA-2.7/2K5	NRND	SOP	DCQ	6	2500	None	Call TI	Level-3-240C-168 HR
REG103GA-3	NRND	SOP	DCQ	6	78	None	Call TI	Level-3-240C-168 HR
REG103GA-3.3	NRND	SOP	DCQ	6	78	None	Call TI	Level-3-240C-168 HR
REG103GA-3.3/2K5	NRND	SOP	DCQ	6	2500	None	Call TI	Level-3-240C-168 HR
REG103GA-3/2K5	NRND	SOP	DCQ	6	2500	None	Call TI	Level-3-240C-168 HR
REG103GA-5	NRND	SOP	DCQ	6	78	None	Call TI	Level-2-240C-1 YEAR
REG103GA-5/2K5	NRND	SOP	DCQ	6	2500	None	Call TI	Level-2-240C-1 YEAR
REG103GA-A	NRND	SOP	DCQ	6	78	None	Call TI	Level-3-240C-168 HR

Orderable Device	Status ⁽¹⁾	Package Type	Package Drawing	Pins	Package Qty	Eco Plan ⁽²⁾	Lead/Ball Finish	MSL Peak Temp ⁽³⁾
REG103GA-A/2K5	NRND	SOP	DCQ	6	2500	None	Call TI	Level-3-240C-168 HR
REG103UA-2.5	NRND	SOIC	D	8	100	None	CU NIPDAU	Level-3-220C-168 HR
REG103UA-2.5/2K5	NRND	SOIC	D	8	2500	None	CU NIPDAU	Level-3-220C-168 HR
REG103UA-2.7	NRND	SOIC	D	8	100	None	CU NIPDAU	Level-3-220C-168 HR
REG103UA-2.7/2K5	NRND	SOIC	D	8	2500	None	CU NIPDAU	Level-3-220C-168 HR
REG103UA-3	NRND	SOIC	D	8	100	None	CU NIPDAU	Level-3-220C-168 HR
REG103UA-3.3	NRND	SOIC	D	8	100	None	CU NIPDAU	Level-3-220C-168 HR
REG103UA-3.3/2K5	NRND	SOIC	D	8	2500	None	CU NIPDAU	Level-3-220C-168 HR
REG103UA-3/2K5	NRND	SOIC	D	8	2500	None	CU NIPDAU	Level-3-220C-168 HR
REG103UA-5	NRND	SOIC	D	8	100	None	CU NIPDAU	Level-3-220C-168 HR
REG103UA-5/2K5	NRND	SOIC	D	8	2500	None	CU NIPDAU	Level-3-220C-168 HR
REG103UA-A	NRND	SOIC	D	8	100	None	CU NIPDAU	Level-3-220C-168 HR
REG103UA-A/2K5	NRND	SOIC	D	8	2500	None	CU NIPDAU	Level-3-220C-168 HR

⁽¹⁾ The marketing status values are defined as follows:

ACTIVE: Product device recommended for new designs.

LIFEBUY: TI has announced that the device will be discontinued, and a lifetime-buy period is in effect.

NRND: Not recommended for new designs. Device is in production to support existing customers, but TI does not recommend using this part in a new design.

PREVIEW: Device has been announced but is not in production. Samples may or may not be available.

OBSOLETE: TI has discontinued the production of the device.

⁽²⁾ Eco Plan - May not be currently available - please check <http://www.ti.com/productcontent> for the latest availability information and additional product content details.

None: Not yet available Lead (Pb-Free).

Pb-Free (RoHS): TI's terms "Lead-Free" or "Pb-Free" mean semiconductor products that are compatible with the current RoHS requirements for all 6 substances, including the requirement that lead not exceed 0.1% by weight in homogeneous materials. Where designed to be soldered at high temperatures, TI Pb-Free products are suitable for use in specified lead-free processes.

Green (RoHS & no Sb/Br): TI defines "Green" to mean "Pb-Free" and in addition, uses package materials that do not contain halogens, including bromine (Br) or antimony (Sb) above 0.1% of total product weight.

⁽³⁾ MSL, Peak Temp. -- The Moisture Sensitivity Level rating according to the JEDEC industry standard classifications, and peak solder temperature.

Important Information and Disclaimer: The information provided on this page represents TI's knowledge and belief as of the date that it is provided. TI bases its knowledge and belief on information provided by third parties, and makes no representation or warranty as to the accuracy of such information. Efforts are underway to better integrate information from third parties. TI has taken and continues to take reasonable steps to provide representative and accurate information but may not have conducted destructive testing or chemical analysis on incoming materials and chemicals. TI and TI suppliers consider certain information to be proprietary, and thus CAS numbers and other limited information may not be available for release.

In no event shall TI's liability arising out of such information exceed the total purchase price of the TI part(s) at issue in this document sold by TI to Customer on an annual basis.

DCQ (R-PDSO-G6)

PLASTIC SMALL-OUTLINE

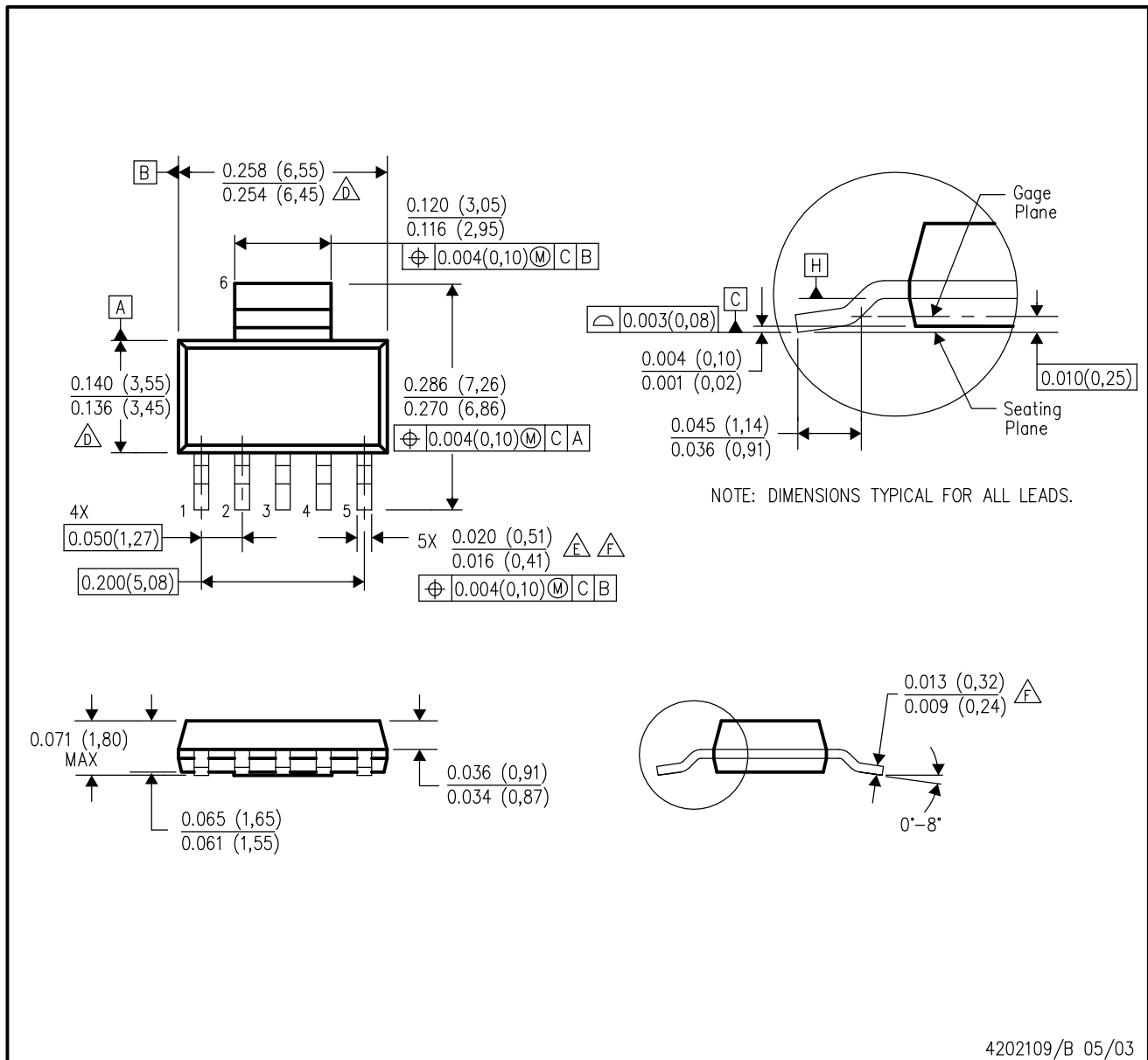

- NOTES:
- A. All linear dimensions are in inches (millimeters).
 - B. This drawing is subject to change without notice.
 - C. Controlling dimension in inches.
 - $\triangle D$ Body length and width dimensions are determined at the outermost extremes of the plastic body exclusive of mold flash, tie bar burrs, gate burrs, and interlead flash, but including any mismatch between the top and the bottom of the plastic body.
 - $\triangle E$ Lead width dimension does not include dambar protrusion.
 - $\triangle F$ Lead width and thickness dimensions apply to solder plated leads.
 - G. Interlead flash allow 0.008 inch max.
 - H. Gate burr/protrusion max. 0.006 inch.
 - I. Datums A and B are to be determined at Datum H.
 - J. Package dimensions per JEDEC outline drawing TO-261, issue B, dated Feb. 1999. This variation is not yet included.

KTT (R-PSFM-G5)

PLASTIC FLANGE-MOUNT PACKAGE

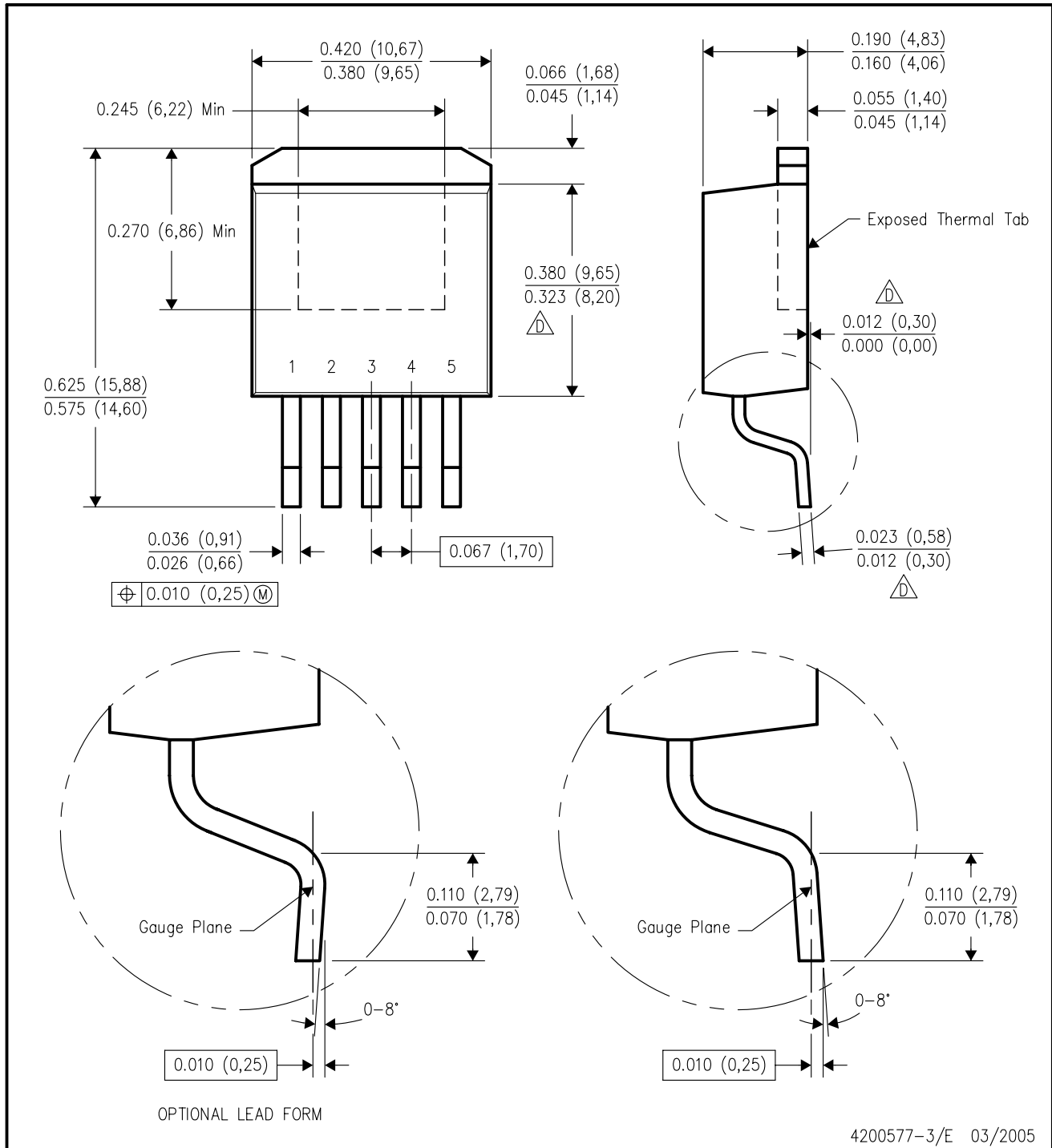

- NOTES:
- A. All linear dimensions are in inches (millimeters).
 - B. This drawing is subject to change without notice.
 - C. Body dimensions do not include mold flash or protrusion. Mold flash or protrusion not to exceed 0.005 (0,13) per side.
- ⚠ Falls within JEDEC TO-263 variation BA, except minimum lead thickness, maximum seating height, and minimum body length.

D (R-PDSO-G8)

PLASTIC SMALL-OUTLINE PACKAGE



- NOTES:
- A. All linear dimensions are in inches (millimeters).
 - B. This drawing is subject to change without notice.
 - C. Body dimensions do not include mold flash or protrusion not to exceed 0.006 (0,15).
 - D. Falls within JEDEC MS-012 variation AA.

IMPORTANT NOTICE

Texas Instruments Incorporated and its subsidiaries (TI) reserve the right to make corrections, modifications, enhancements, improvements, and other changes to its products and services at any time and to discontinue any product or service without notice. Customers should obtain the latest relevant information before placing orders and should verify that such information is current and complete. All products are sold subject to TI's terms and conditions of sale supplied at the time of order acknowledgment.

TI warrants performance of its hardware products to the specifications applicable at the time of sale in accordance with TI's standard warranty. Testing and other quality control techniques are used to the extent TI deems necessary to support this warranty. Except where mandated by government requirements, testing of all parameters of each product is not necessarily performed.

TI assumes no liability for applications assistance or customer product design. Customers are responsible for their products and applications using TI components. To minimize the risks associated with customer products and applications, customers should provide adequate design and operating safeguards.

TI does not warrant or represent that any license, either express or implied, is granted under any TI patent right, copyright, mask work right, or other TI intellectual property right relating to any combination, machine, or process in which TI products or services are used. Information published by TI regarding third-party products or services does not constitute a license from TI to use such products or services or a warranty or endorsement thereof. Use of such information may require a license from a third party under the patents or other intellectual property of the third party, or a license from TI under the patents or other intellectual property of TI.

Reproduction of information in TI data books or data sheets is permissible only if reproduction is without alteration and is accompanied by all associated warranties, conditions, limitations, and notices. Reproduction of this information with alteration is an unfair and deceptive business practice. TI is not responsible or liable for such altered documentation.

Resale of TI products or services with statements different from or beyond the parameters stated by TI for that product or service voids all express and any implied warranties for the associated TI product or service and is an unfair and deceptive business practice. TI is not responsible or liable for any such statements.

Following are URLs where you can obtain information on other Texas Instruments products and application solutions:

Products		Applications	
Amplifiers	amplifier.ti.com	Audio	www.ti.com/audio
Data Converters	dataconverter.ti.com	Automotive	www.ti.com/automotive
DSP	dsp.ti.com	Broadband	www.ti.com/broadband
Interface	interface.ti.com	Digital Control	www.ti.com/digitalcontrol
Logic	logic.ti.com	Military	www.ti.com/military
Power Mgmt	power.ti.com	Optical Networking	www.ti.com/opticalnetwork
Microcontrollers	microcontroller.ti.com	Security	www.ti.com/security
		Telephony	www.ti.com/telephony
		Video & Imaging	www.ti.com/video
		Wireless	www.ti.com/wireless

Mailing Address: Texas Instruments
Post Office Box 655303 Dallas, Texas 75265