

NCR (Concave Electrode) Type

Article *1	NCR104 (NCR108)	NCR162	NCR164
Size Code Inch	0402 × 4(0804)	0603 × 2(0606)	0603 × 4(1206)
Size Code mm	1005 × 4(2010)	1608 × 2(1616)	1608 × 4(3216)

*1 (): Conventional Type No.

Construction

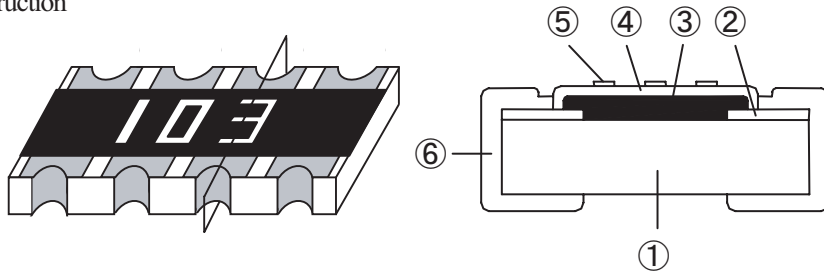

Symbol	Material List
①	Alumina substrate
②	Conductor
③	Resistive film
④	Over coat
⑤	Marking
⑥	Side termination

Type Designation

NCR164	102	J	V
Article *1	Resistance	Tolerance (%)	Packaging
NCR104 (NCR108)	3 digit	Symbol Tolerance	Symbol Packaging
NCR162	(Resistance) (Marking)	J ± 5	B Bulk
NCR164	0 Ω → 000 1k Ω > 102	0 Ω type is no marking	V Paper aping

Dimension

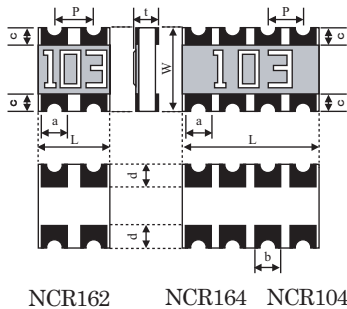

Article	L	W	a	b
NCR104	2.00±0.10	1.00±0.10	0.28±0.10	(0.28)*2
NCR162	1.60±0.15	1.60±0.15	0.50±0.15	(0.50)*2
NCR164	3.20±0.15			

Article	c	d	p	t
NCR104	0.20±0.10	0.28±0.10	(0.50)*2	0.35±0.10
NCR162	0.35±0.15	0.40±0.15	(0.80)*2	0.45±0.10
NCR164				

*2 (): Reference value

Rating

Article *1	Rated Wattage (70°C)	Tolerance (%)	Resistance Range E-24 Series (Ω)	T.C.R. (ppm/°C)	Max. Working Voltage (V)	Max. Overload Voltage (V)	Circuit	0 Ω Type	
								Rated Current	Resistance
NCR104 (NCR108)	0.031W/Element 0.063W/Element	J: ± 5	10 ~ 1M	±200	50	100		1A/Element	Max. 50mΩ
NCR162									
NCR164									

Operating temperature range : -55 °C ~ +125 °C
Please contact our sales offices about custom use circuits.

Power rating

Refer page 11

Packaging

Refer page 12

ACR (Convex Electrode) Type

Article *1	ACR102 (CRA104)	ACR104 (CRA108)	ACR164 (CRA168)
Size Code Inch	0402 × 2(0404)	0402 × 4(0804)	0603 × 4(1206)
Size Code mm	1005 × 2(1010)	1005 × 4(2010)	1608 × 4(3216)

*1 (): Conventional Type No.

Construction

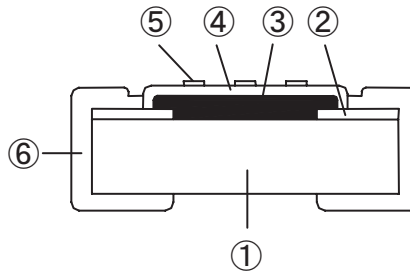
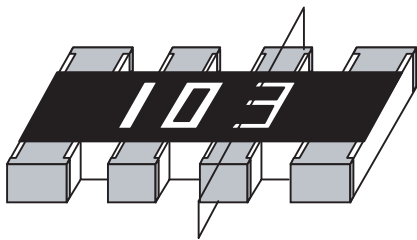

Symbol	Material List
①	Alumina substrate
②	Conductor
③	Resistive film
④	Over coat
⑤	Marking *2
⑥	Side termination

*2 ACR102 and ACR104: No marking

Type Designation

Article *1	Resistance	Tolerance (%)	Packaging
ACR164 (CRA168)	102	J	V
ACR102 (CRA104)	3 digit (Resistance) (Marking) 0Ω → 000 1kΩ → 102	Symbol Tolerance J ±5 0Ω type is no marking	Symbol Packaging B Bulk V Paper Taping
ACR104 (CRA108)			
ACR164 (CRA168)			

Dimension

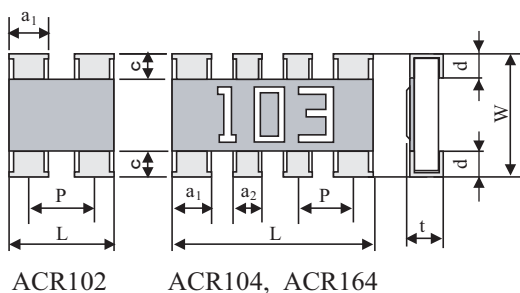

Article	L	W	a1	a2
ACR102	1.00±0.05	1.00±0.05	0.33±0.05	-
ACR104	2.00±0.20	1.00±0.15	0.40±0.15	0.30±0.15
ACR164	3.20±0.10	1.60±0.10	0.60±0.15	0.40±0.15

Article	c	d	p	t
ACR102	0.15±0.10	0.25±0.10	(0.65)*3	0.35±0.05
ACR104	0.20±0.15	0.20±0.15	(0.50)*3	0.35±0.10
ACR164	0.30±0.20	0.25±0.15	(0.80)*3	0.50±0.10

*3 (): Reference value

Rating

Article	Rated Wattage (70°C)	Tolerance (%)	Resistance Range E-24 Series (Ω)	T.C.R. (ppm/°C)	Max. Working Voltage (V)	Max. Overload Voltage (V)	Circuit	0Ω Type	
								Rated Current	Resistance
ACR102 (CRA104)	0.063W/Element	J	10 ~ 1M	±200	50	100		1A/Element	Max. 50mΩ
ACR104 (CRA108)	0.031W/Element								
ACR164 (CRA168)	0.063W/Element								

Operating temperature range : -55 °C ~ +125°C

Power rating

Refer page 11

Packaging

Refer page 12

NCR (Concave Electrode) Type ; NCR3A8 (NCR3110A), NCR3B8 (NCR3110B)

■ Construction

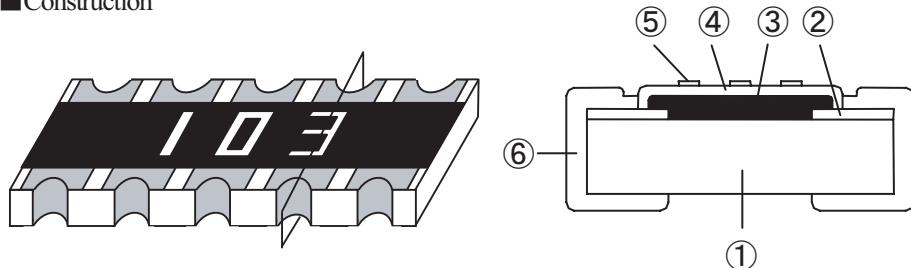

*1 (): Conventional Type No.

Symbol	Material List		
①	Alumina substrate		
②	Conductor		
③	Resistive film		
④	Over coat		
⑤	Marking	NCR3A8	Orange
		NCR3B8	White
⑥	Side termination		

■ Type Designation

NCR3A8 (NCR3110A)	103	J	E
Article *1	Resistance	Tolerance (%)	Packaging
NCR3A8 (NCR3110A)	3 digit	Symbol	Symbol
NCR3B8 (NCR3110B)	(Resistance) (Marking) 10kΩ → 103	Tolerance	Packaging
		J	± 5
			B
			Bulk
			E
			Embossed taping

■ Dimension

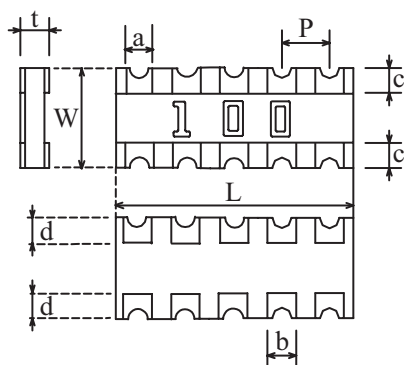

Article	L	W	a	b
NCR3A8	6.40±0.20	3.10±0.20	0.60±0.15	0.50±0.20
NCR3B8				

Article	c	d	p	t
NCR3A8	0.35±0.15	0.50±0.30	(1.27)*2	0.55±0.10
NCR3B8				

*2 (): Reference value

■ Rating

Article *1	Rated Wattage (70°C)	Tolerance (%)	Resistance Range E-12 Series (Ω)	T.C.R. (ppm/°C)	Max. Working Voltage (V)	Max. Overload Voltage (V)	Circuit
NCR3A8 (NCR3110A)	0.063W/Element	J:± 5	100 ~ 470k	±250	50	100	
NCR3B8 (NCR3110B)							

Operating temperature range : -55°C ~ +125°C

■ Power rating

Refer page 11

■ Packaging

Refer page 12