



CHENMKO ENTERPRISE CO.,LTD

CHT2222TPT

**SURFACE MOUNT
NPN Switching Transistor**

VOLTAGE 40 Volts CURRENT 0.6 Ampere

Lead free devices

APPLICATION

- * Telephony and professional communication equipment.
- * Other switching applications.

FEATURE

- * Small surface mounting type. (SC-75/SOT-416)
- * High current (Max.=600mA).
- * Suitable for high packing density.
- * Low voltage (Max.=40V) .
- * High saturation current capability.
- * Voltage controlled small signal switch.

CONSTRUCTION

- * NPN Switching Transistor

MARKING

- * NT

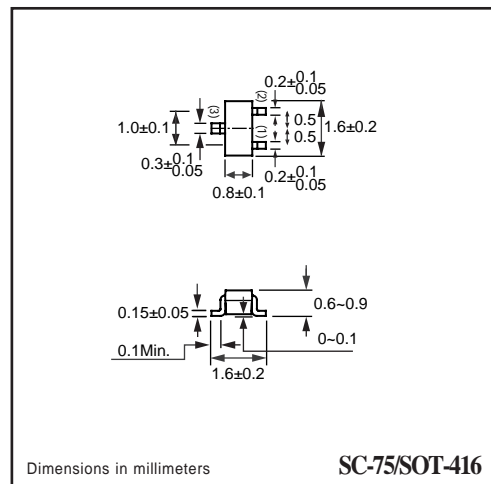

CIRCUIT

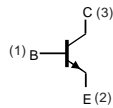

LIMITING VALUES

In accordance with the Absolute Maximum Rating System (IEC 60134).

SYMBOL	PARAMETER	CONDITIONS	MIN.	MAX.	UNIT
V _{CB0}	collector-base voltage	open emitter	-	75	V
V _{CEO}	collector-emitter voltage	open base	-	40	V
V _{EBO}	emitter-base voltage	open collector	-	6	V
I _C	collector current (DC)		-	600	mA
I _{CM}	peak collector current		-	800	mA
I _{BM}	peak base current		-	200	mA
P _{tot}	total power dissipation	T _{amb} ≤ 25 °C; note 1	-	250	mW
T _{stg}	storage temperature		-65	+150	°C
T _j	junction temperature		-	150	°C
T _{amb}	operating ambient temperature		-65	+150	°C

Note

1. Transistor mounted on an FR4 printed-circuit board.

RATING CHARACTERISTIC CURVES (CHT2222TPT)

THERMAL CHARACTERISTICS

SYMBOL	PARAMETER	CONDITIONS	VALUE	UNIT
$R_{th\ j-a}$	thermal resistance from junction to ambient	note 1	357	K/W

Note

1. Transistor mounted on an FR4 printed-circuit board.

CHARACTERISTICS

$T_{amb} = 25\text{ }^{\circ}\text{C}$ unless otherwise specified.

SYMBOL	PARAMETER	CONDITIONS	MIN.	MAX.	UNIT
I_{CBO}	collector cut-off current	$I_E = 0; V_{CB} = 60\text{ V}$	–	10	nA
		$I_C = 0; V_{CB} = 60\text{ V}; T_j = 125\text{ }^{\circ}\text{C}$	–	10	uA
I_{EBO}	emitter cut-off current	$I_C = 0; V_{EB} = 5\text{ V}$	–	10	nA
h_{FE}	DC current gain	$I_C = 0.1\text{ mA}; V_{CE} = 10\text{ V};$ note 1	35	–	
		$I_C = 1.0\text{ mA}; V_{CE} = 10\text{ V}$	50	–	
		$I_C = 10\text{ mA}; V_{CE} = 10\text{ V}$	75	–	
		$I_C = 10\text{ mA}; V_{CE} = 10\text{ V}; T_{amb} = -55^{\circ}\text{C}$	35	–	
		$I_C = 150\text{ mA}; V_{CE} = 10\text{ V}$	100	300	
		$I_C = 150\text{ mA}; V_{CE} = 1.0\text{ V}$	50	–	
V_{CEsat}	collector-emitter saturation voltage	$I_C = 150\text{ mA}; I_B = 15\text{ mA}$	–	300	mV
		$I_C = 500\text{ mA}; I_B = 50\text{ mA}$	–	1	V
V_{BEsat}	base-emitter saturation voltage	$I_C = 150\text{ mA}; I_B = 10\text{ mA}$	0.6	1.2	V
		$I_C = 500\text{ mA}; I_B = 50\text{ mA}$	–	2.0	V
C_c	collector capacitance	$I_E = i_e = 0; V_{CB} = 5\text{ V}; f = 1\text{ MHz}$	–	8	pF
C_e	emitter capacitance	$I_C = i_c = 0; V_{BE} = 500\text{ mV}; f = 1\text{ MHz}$	–	25	pF
f_T	transition frequency	$I_C = 20\text{ mA}; V_{CE} = 20\text{ V}; f = 100\text{ MHz}$	300	–	MHz
F	noise figure	$I_C = 100\text{ }\mu\text{A}; V_{CE} = 5\text{ V}; R_S = 1\text{ k}\Omega; f = 1.0\text{ kHz}$	–	4	dB

Switching times (between 10% and 90% levels);

t_{on}	turn-on time	$I_{Con} = 150\text{ mA}; I_{Bon} = 15\text{ mA}; I_{Boff} = -15\text{ mA}$	–	35	ns
t_d	delay time		–	15	ns
t_r	rise time		–	20	ns
t_{off}	turn-off time		–	250	ns
t_s	storage time		–	200	ns
t_f	fall time		–	60	ns

Note

1. Pulse test: $t_p \leq 300\text{ }\mu\text{s}; \delta \leq 0.02.$

RATING CHARACTERISTIC CURVES (CHT2222TPT)

Typical Pulsed Current Gain vs Collector Current

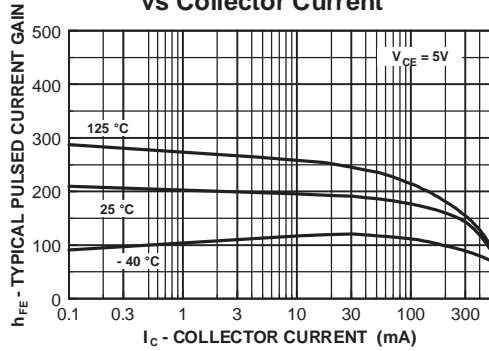

Collector-Emitter Saturation Voltage vs Collector Current

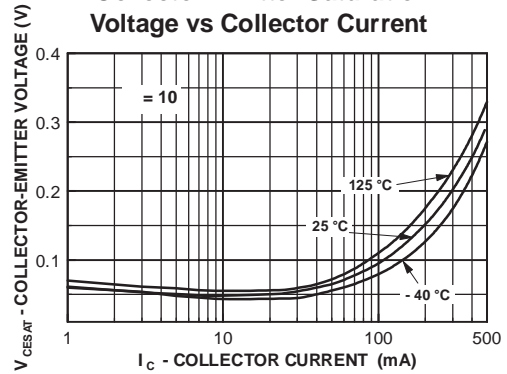

Base-Emitter Saturation Voltage vs Collector Current

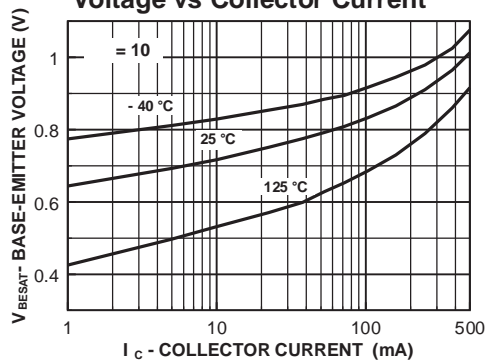

Base-Emitter ON Voltage vs Collector Current

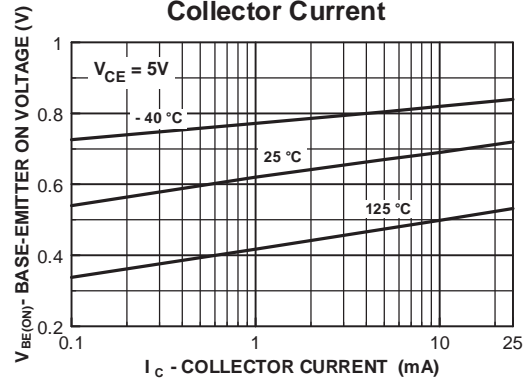

Collector-Cutoff Current vs Ambient Temperature

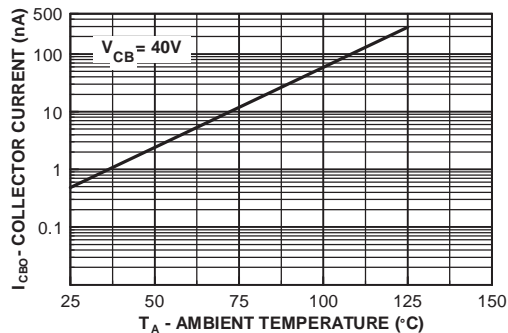

Emitter Transition and Output Capacitance vs Reverse Bias Voltage

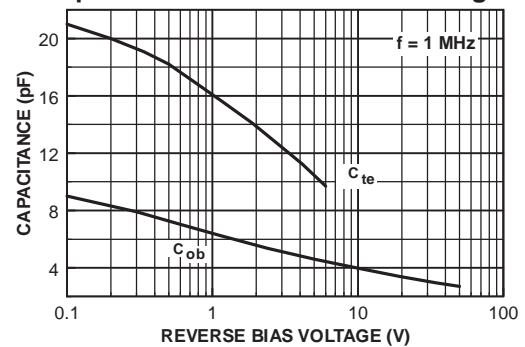

RATING CHARACTERISTIC CURVES (CHT2222TPT)

**Turn On and Turn Off Times
vs Collector Current**

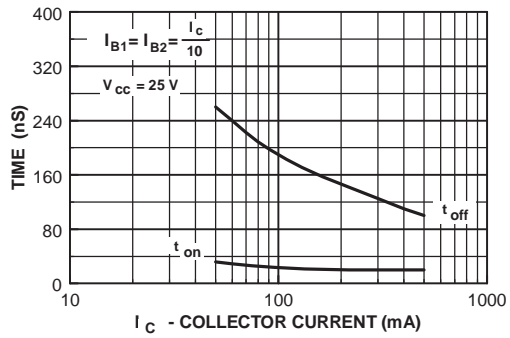

**Switching Times
vs Collector Current**

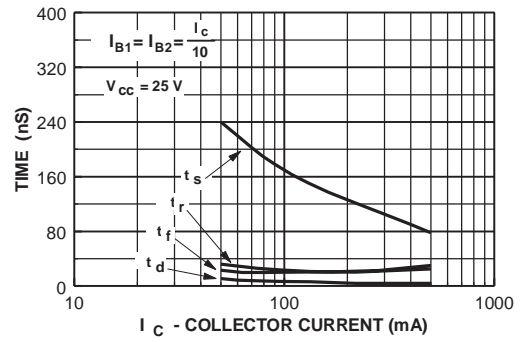

**Power Dissipation vs
Ambient Temperature**

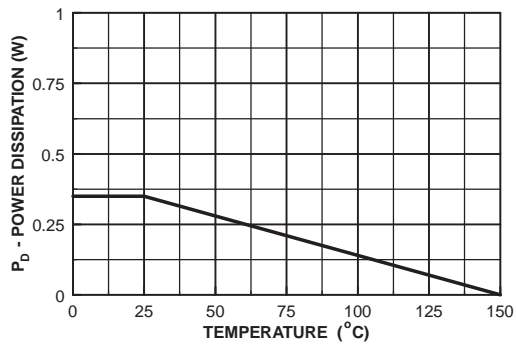

RATING CHARACTERISTIC CURVES (CHT2222TPT)

Common Emitter Characteristics

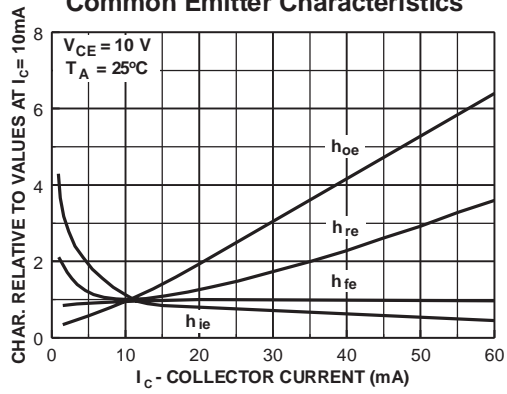

Common Emitter Characteristics

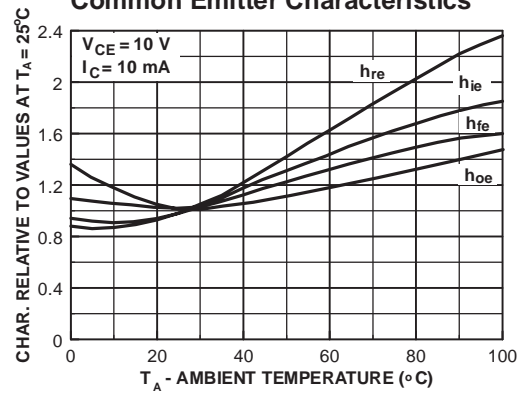

Common Emitter Characteristics

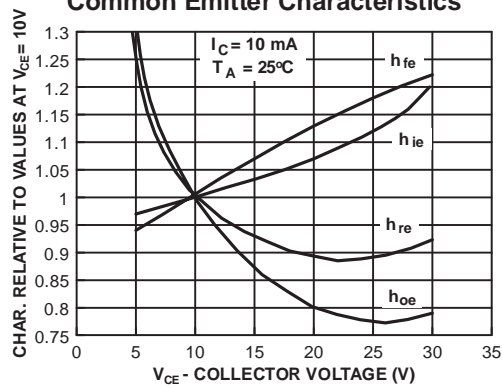

RATING CHARACTERISTIC CURVES (CHT2222TPT)

Test Circuits

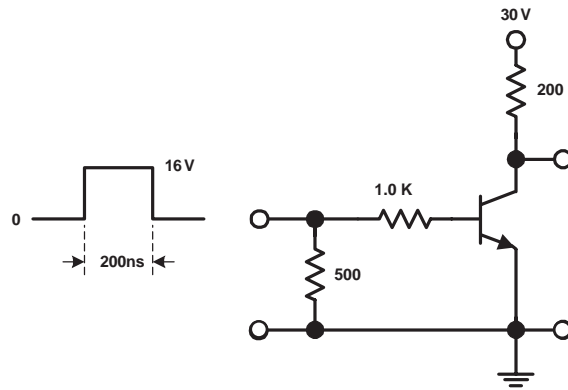

Saturated Turn-On Switching Time

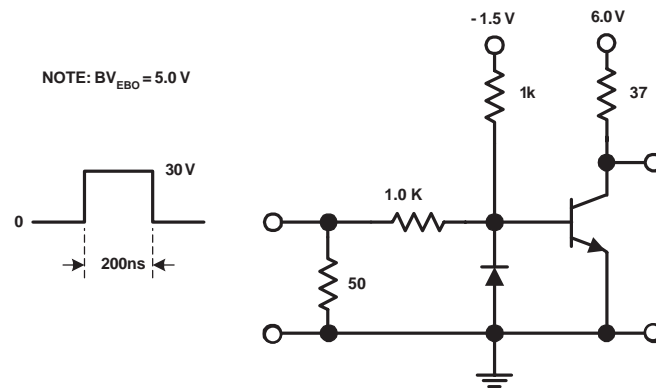

Saturated Turn-Off Switching Time