



CHENMKO ENTERPRISE CO.,LTD

2N7002PT

SURFACE MOUNT

N-Channel Enhancement Mode Field Effect Transistor

VOLTAGE 60 Volts CURRENT 0.250 Ampere

Lead free devices

APPLICATION

- * Servo motor control.
- * Power MOSFET gate drivers.
- * Other switching applications.

FEATURE

- * Small surface mounting type. (SOT-23)
- * High density cell design for low R_{DS(ON)}.
- * Suitable for high packing density.
- * Rugged and reliable.
- * High saturation current capability.
- * Voltage controlled small signal switch.

CONSTRUCTION

- * N-Channel Enhancement

MARKING

- * 7002

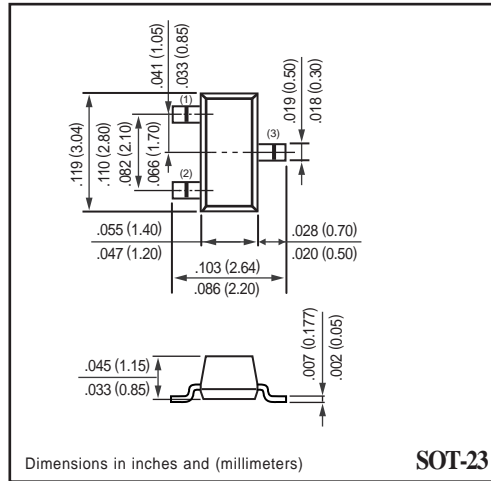
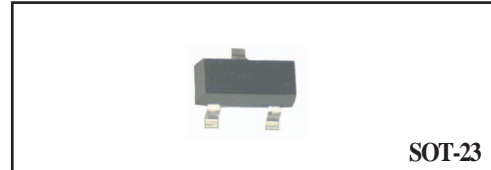

CIRCUIT

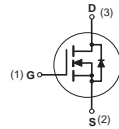

Absolute Maximum Ratings T_A = 25°C unless otherwise noted

Symbol	Parameter	2N7002PT	Units	
V _{DSS}	Drain-Source Voltage	60	V	
V _{DGR}	Drain-Gate Voltage (R _{GS} ≤ 1 MΩ)	60	V	
V _{GSS}	Gate-Source Voltage - Continuous	±20	V	
	- Non Repetitive (tp < 50μs)	±40		
I _D	Maximum Drain Current - Continuous - Pulsed	T _A = 25°C	250	mA
		T _A = 70°C	190	
P _D	Maximum Power Dissipation	T _A = 25°C	350	mW
		T _A = 70°C	220	mW
T _J , T _{STG}	Operating and Storage Temperature Range	-55 to 150	°C	
T _L	Maximum Lead Temperature for Soldering Purposes, 1/16" from Case for 10 Seconds	300	°C	

Thermal characteristics

R _{θJA}	Thermal Resistance, Junction-to-Ambient	357	°C/W
------------------	---	-----	------

RATING CHARACTERISTIC CURVES (2N7002PT)

Electrical Characteristics $T_A = 25^\circ\text{C}$ unless otherwise noted

Symbol	Parameter	Conditions	Min	Typ	Max	Units
--------	-----------	------------	-----	-----	-----	-------

OFF CHARACTERISTICS

BV_{DSS}	Drain-Source Breakdown Voltage	$V_{GS} = 0\text{ V}, I_D = 10\ \mu\text{A}$	60	70		V
I_{DSS}	Zero Gate Voltage Drain Current	$V_{DS} = 60\text{ V}, V_{GS} = 0\text{ V}$			1	μA
					0.5	mA
I_{GSSF}	Gate - Body Leakage, Forward	$V_{GS} = 15\text{ V}, V_{DS} = 0\text{ V}$			10	nA
I_{GSSR}	Gate - Body Leakage, Reverse	$V_{GS} = -15\text{ V}, V_{DS} = 0\text{ V}$			-10	nA

ON CHARACTERISTICS (Note 1)

$V_{GS(th)}$	Gate Threshold Voltage	$V_{DS} = V_{GS}, I_D = 250\ \mu\text{A}$	1	2.0	2.5	V
$R_{DS(on)}$	Static Drain-Source On-Resistance	$V_{GS} = 10\text{ V}, I_D = 250\text{ mA}$		1.7	3.0	Ω
		$V_{GS} = 4.0\text{ V}, I_D = 100\text{ mA}$		2.5	4.0	
$V_{DS(on)}$	Drain-Source On-Voltage	$V_{GS} = 10\text{ V}, I_D = 500\text{ mA}$		0.6	3.75	V
		$V_{GS} = 5.0\text{ V}, I_D = 50\text{ mA}$		0.09	1.5	
$I_{D(on)}$	On-State Drain Current	$V_{GS} = 10\text{ V}, V_{DS} = 7.5V_{DS(on)}$	800	1800		mA
		$V_{GS} = 4.5\text{ V}, V_{DS} = 10V_{DS(on)}$	500	700		
g_{FS}	Forward Transconductance	$V_{DS} = 15\text{ V}, I_D = 200\text{ mA}$		250		mS

DYNAMIC CHARACTERISTICS

Q_g	Total Gate Charge	$V_{DS} = 30\text{ V}, V_{GS} = 10\text{ V},$ $I_D = 250\text{ mA}$		0.6	1.0	nC
Q_{gs}	Gate-Source Charge			0.06	25	
Q_{gd}	Gate-Drain Charge			0.06	5	
C_{iss}	Input Capacitance	$V_{DS} = 25\text{ V}, V_{GS} = 0\text{ V},$ $f = 1.0\text{ MHz}$		25	50	pF
C_{oss}	Output Capacitance			6	25	
C_{rss}	Reverse Transfer Capacitance			1.2	5	
t_{on}	Turn-On Time	$V_{DD} = 30\text{ V}, R_L = 200\ \Omega,$ $I_D = 100\text{ mA}, V_{GS} = 10\text{ V},$ $R_{GEN} = 10\ \Omega$		7.5	20	nS
t_r				6		
t_{off}	Turn-Off Time	$V_{DD} = 30\text{ V}, R_L = 200\ \Omega,$ $I_D = 100\text{ mA}, V_{GS} = 10\text{ V},$ $R_{GEN} = 10\ \Omega$		7.5	20	nS
t_f				3		

DRAIN-SOURCE DIODE CHARACTERISTICS AND MAXIMUM RATINGS

I_S	Maximum Continuous Drain-Source Diode Forward Current			115	mA	
I_{SM}	Maximum Pulsed Drain-Source Diode Forward Current			0.8	A	
V_{SD}	Drain-Source Diode Forward Voltage	$V_{GS} = 0\text{ V}, I_S = 200\text{ mA}$ (Note 1)		0.85	1.2	V

Note:

1. Pulse Test: Pulse Width < 300 μs , Duty Cycle < 2.0%.

RATING CHARACTERISTIC CURVES (2N7002PT)

Typical Electrical Characteristics

Figure 1. On-Region Characteristics

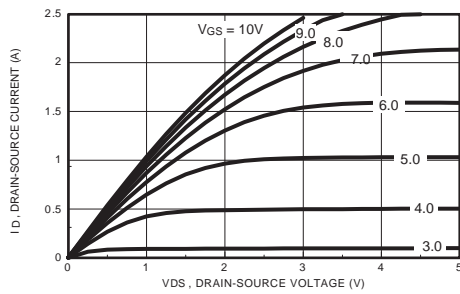

Figure 2. On-Resistance Variation with Gate Voltage and Drain Current

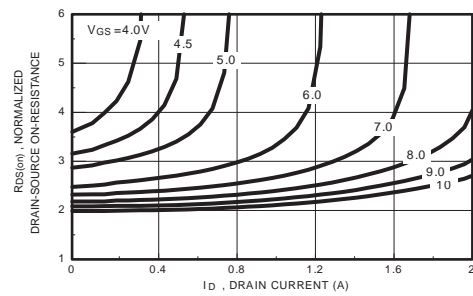

Figure 3. On-Resistance Variation with Temperature

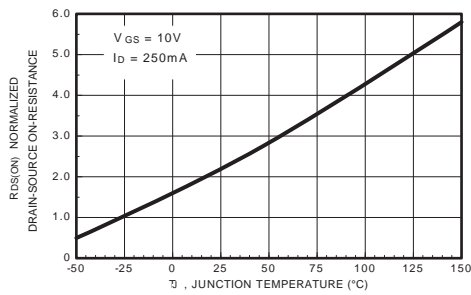

Figure 4. On-Resistance Variation with Drain Current and Temperature

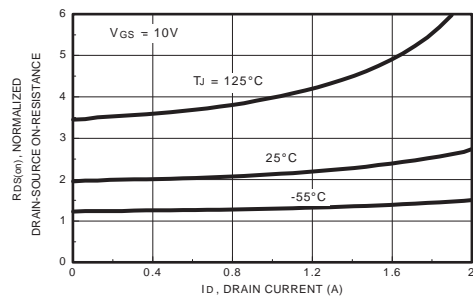

Figure 5. Transfer Characteristics

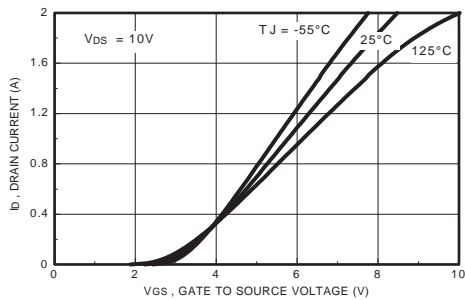
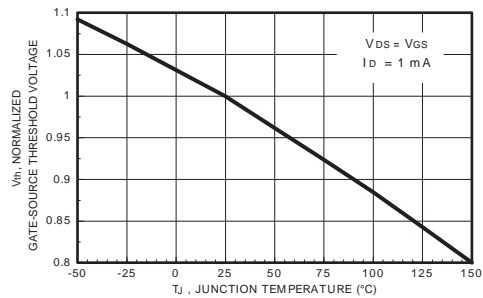

Figure 6. Gate Threshold Variation with Temperature



RATING CHARACTERISTIC CURVES (2N7002PT)

Typical Electrical Characteristics (continued)

Figure 7. Breakdown Voltage Variation with Temperature

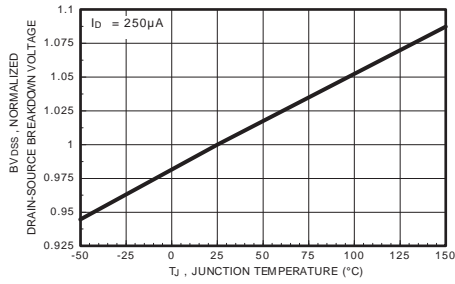

Figure 8. Body Diode Forward Voltage Variation with Drain Current

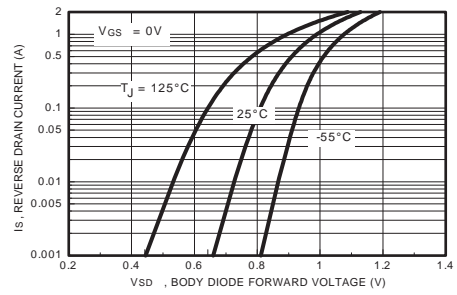

Figure 9. Capacitance Characteristics

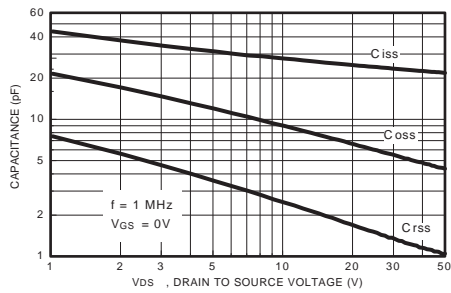

Figure 10. Gate Charge Characteristics

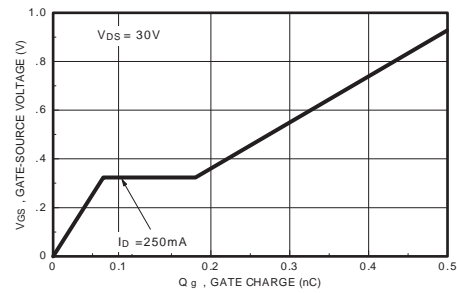

Figure 11.

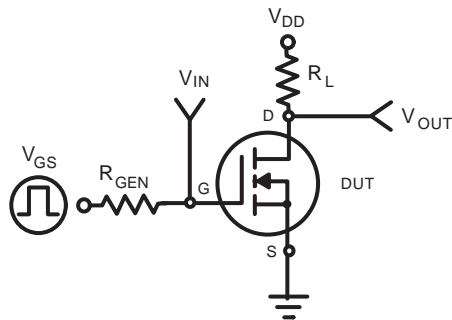
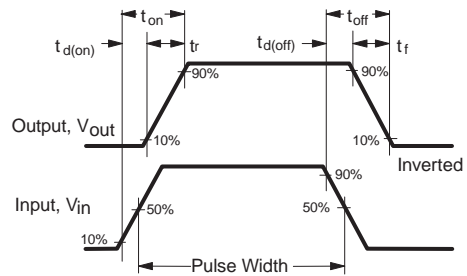

Figure 12. Switching Waveforms



RATING CHARACTERISTIC CURVES (2N7002PT)

Typical Electrical Characteristics (continued)

Figure 13. 2N7002PT Maximum Safe Operating Area

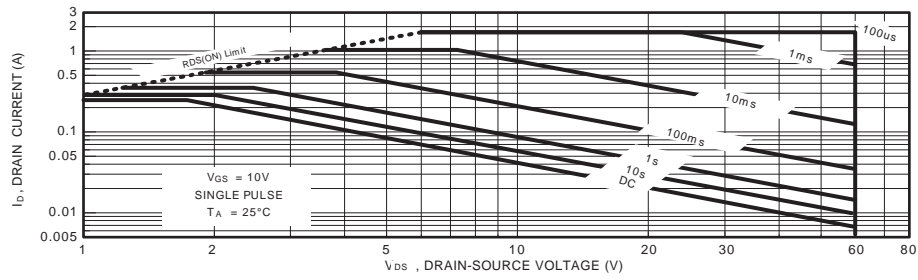

Figure 14. 2N7002PT Transient Thermal Response Curve

