

ELM7Sxx,ELM7SxxB SERIES CMOS LOGIC IC

■ GENERAL DESCRIPTION

• ELM7Sxx,ELM7SxxB Series are CMOS ICs. They realize a high speed operation similar to LS-TTL with a lower power consumption by CMOS features. An inner circuit structure of 3-stages logic gates obtains wider noise immunity and constant output.

• ELM7S66,ELM7S66B are CMOS analog switches. They realize a high speed operation with a low power consumption by CMOS features. With a low on resistance and a high transmission rate, they realize a wider input voltage range.

■ FEATURES

- Very small SOT-25 (2.9 × 1.6 × 1.1mm) 5 - pin package
 SOT-26 (2.9 × 1.6 × 1.1mm) 6 - pin package
- Same electrical characteristics as 74HC Series
- Power voltage range : 2.0 ~ 6.0V
- Operation temp. range : -40 ~ +85°C
- | IOH | = IOL = 2mA (min)

■ SERIES

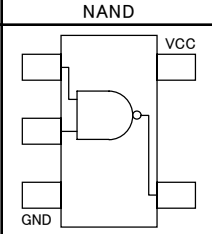
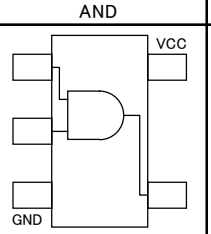
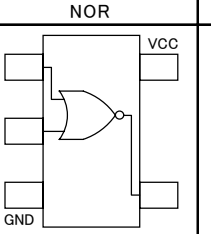
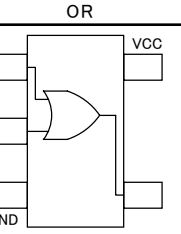
Function	NAND	AND	NOR	OR
Diagram (TOP VIEW)				
Product	ELM7S00 ELM7S00B	ELM7S08 ELM7S08B	ELM7S02 ELM7S02B	ELM7S32 ELM7S32B

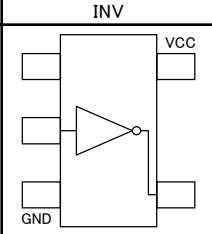
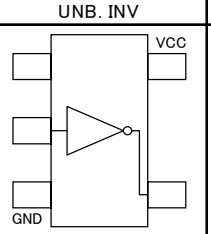
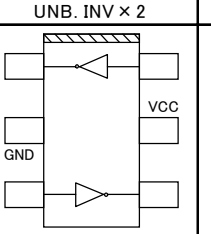
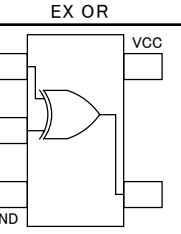
Function	INV	UNB. INV	UNB. INV × 2	EX OR
Diagram (TOP VIEW)				
Product	ELM7S04 ELM7S04B	ELM7SU04 ELM7SU04B	ELM7SU04W ELM7SU04BW	ELM7S86 ELM7S86B

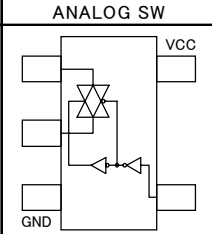
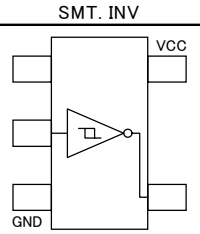
Function	ANALOG SW	SMT. INV
Diagram (TOP VIEW)		
Product	ELM7S66 ELM7S66B	ELM7S14 ELM7S14B

ELM7Sxx,ELM7SxxB SERIES CMOS LOGIC

■ SELECTION GUIDE

Symbol			
a,b	Function	00	NAND
		08	AND
		02	NOR
		32	OR
		04	INV
		U04	UNB.INV
		86	EX OR
		66	Analog SW
		14	SMT. INV

ELM7Sxx : Sn/Pb

a b

ELM7SxxB : Pb-Free

a b

ELM7S00,ELM7S00B 2-input NAND Gate

DESCRIPTION

ELM7S00,ELM7S00B are CMOS 2-input NAND gate ICs. They realize a high speed operation similar to LS-TTL with a lower power consumption by CMOS features. An inner circuit structure of 3-stages logic gates obtains wider noise immunity and constant output.

FEATURES

- Package : SOT-25 package
- Same electrical characteristics as 74HC Series
- Power voltage range : 2.0 ~ 6.0V
- Operation temp. range : -40 ~ +85°C
- | IOH | = IOL = 2mA (min)

PIN CONFIGURATION

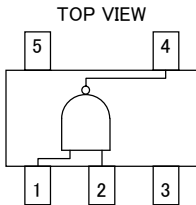

Pin No.	Pin Name
1	INB
2	INA
3	GND
4	OUTX
5	VCC

Input		Output
INA	INB	OUTX
Low	Low	High
Low	High	High
High	Low	High
High	High	Low

MARKING

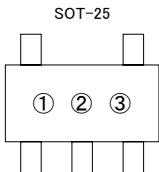

No.	Mark	Contents
①	E	ELM7Sxx, ELM7SxxB series
②	1	ELM7S00, ELM7S00B
③	A~M (excepted I)	Lot No.

MAXIMUM ABSOLUTE RATINGS

Parameter	Symbol	Value	Units
Power Voltage	VCC	-0.5~+7.0	V
Input Voltage	VIN	-0.5~VCC+0.5	V
Output Voltage	VOUT	-0.5~VCC+0.5	V
Input Protection Diode Current	I _{IK}	±20	mA
Output Parasitic Diode Current	I _{OK}	±20	mA
Output Current	I _{OUT}	±25	mA
VCC/GND Current	I _{CC} , I _{GND}	±25	mA
Power Dissipation	P _d	200	mW
Storage Temp.	T _{stg}	-65~+150	°C

CMOS LOGIC IC ELM7S00,ELM7S00B 2-input NAND Gate

■ SUGGESTED OPERATING CONDITION

Parameter	Symbol	Value	Units
Power Voltage	VCC	2.0~6.0	V
Input Voltage	VIN	0~VCC	V
Output Voltage	VOUT	0~VCC	V
Operating Temp.	Top	-40~+85	°C
High-input down-time	tr,tf	0~1000 (VCC=2.0V)	ns
		0~500 (VCC=4.5V)	
		0~400 (VCC=6.0V)	

■ DC ELECTRICAL CHARACTERISTICS

Parameter	Sym.	VCC	Top = 25°C			Top = -40~+85°C		Units	Conditions	
			Min.	Typ.	Max.	Min.	Max.			
Input Voltage	VIH	2.0	1.5	-	-	1.5	-	V		
		4.5	3.15	-	-	3.15	-			
		6.0	4.2	-	-	4.2	-			
	VIL	2.0	-	-	0.5	-	0.5	V		
		4.5	-	-	1.35	-	1.35			
		6.0	-	-	1.8	-	1.8			
Output Voltage	VOH	2.0	1.9	2.0	-	1.9	-	V	VIN=VIH or VIL	IOH = -20 μA
		4.5	4.4	4.5	-	4.4	-			
		6.0	5.9	6.0	-	5.9	-			
		4.5	4.18	4.36	-	4.13	-			
		6.0	5.68	5.84	-	5.63	-			
	VOL	2.0	-	0.0	0.1	-	0.1	V	VIN=VIH	IOL = 20 μA
		4.5	-	0.0	0.1	-	0.1			
		6.0	-	0.0	0.1	-	0.1			
		4.5	-	0.11	0.26	-	0.33			
		6.0	-	0.13	0.26	-	0.33			
Input Current	IIN	6.0	-0.1	-	0.1	-1.0	1.0	μA	VIN = VCC or GND	
Static Current	ICC	6.0	-	-	1.0	-	10.0	μA	VIN = VCC or GND	

■ AC ELECTRICAL CHARACTERISTICS

(CL=15pF, tr=tf=6ns, VCC=5V)

Parameter	Sym.	Top = 25°C			Units	Conditions
		Min.	Typ.	Max.		
High Output Down-time	tTLH	-	4	10	ns	Refer to following test circuit
	tTHL	-	3	10		
Propagation Delay-time	tPLH	-	5	15	ns	Refer to following test circuit
	tPHL	-	5	15		

CMOS LOGIC IC ELM7S00,ELM7S00B 2-input NAND Gate

(CL=50pF, tr=tf=6ns)

Parameter	Sym.	VCC	Top = 25°C			Top = -40~+85°C		Units	Conditions
			Min.	Typ.	Max.	Min.	Max.		
High-Output Down-time	tTLH	2.0	-	18	125	-	155	ns	Refer to test circuit
		4.5	-	7	25	-	31		
		6.0	-	6	21	-	26		
	tTHL	2.0	-	14	125	-	155	ns	
		4.5	-	6	25	-	31		
		6.0	-	6	21	-	26		
Propagation Delay-time	tPLH	2.0	-	16	100	-	125	ns	Refer to test circuit
		4.5	-	8	20	-	25		
		6.0	-	7	17	-	21		
	tPHL	2.0	-	16	100	-	125	ns	
		4.5	-	6	20	-	25		
		6.0	-	5	17	-	21		
Input Capacity	CIN	-	-	5	10	-	10	pF	
Equivalent Inner Capacity	CPD	-	-	10	-	-	-	pF	

* CPD is IC's inner equivalent capacity which is calculated from non-loaded operating current consumption referred to following test circuit. Averaged operating current consumption at non-load is calculated as following formula;
 $ICC (opr) = CPD \cdot VCC \cdot f_{IN} + ICC$

■ TEST CIRCUIT

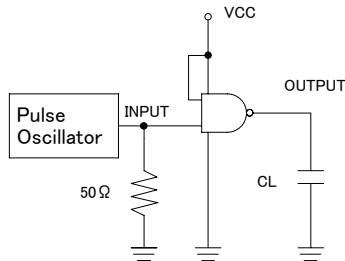

* Output should be opened when measuring current consumption.

■ MEASURED WAVE PATTERN

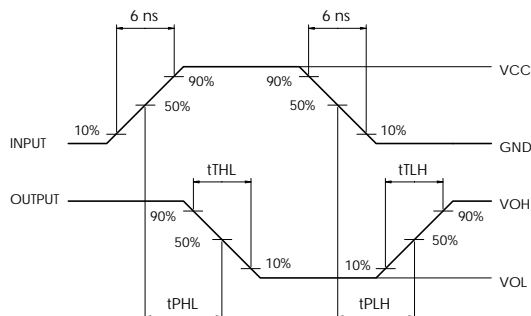

ELM7S08,ELM7S08B 2-input AND Gate

DESCRIPTION

ELM7S08,ELM7S08B are CMOS 2-input AND gate ICs. They realize a high speed operation similar to LS-TTL with a lower power consumption by CMOS features. An inner circuit structure of 3-stages logic gates obtains wider noise immunity and constant output.

FEATURES

- Package : SOT-25 package
- Same electrical characteristics as 74HC Series
- Power voltage range : 2.0 ~ 6.0V
- Operation temp. range : -40 ~ +85°C
- | IOH | = IOL = 2mA (min)

PIN CONFIGURATION

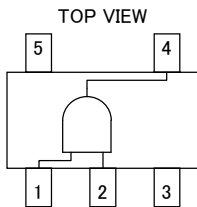

Pin No.	Pin Name
1	INB
2	INA
3	GND
4	OUTX
5	VCC

Input		Output
INA	INB	OUTX
Low	Low	Low
Low	High	Low
High	Low	Low
High	High	High

MARKING

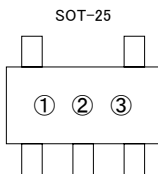

No.	Mark	Contents
①	E	ELM7Sxx, ELM7Sxx series
②	2	ELM7S08, ELM7S08B
③	A~M (excepted I)	Lot No.

MAXIMUM ABSOLUTE RATINGS

Parameter	Symbol	Value	Units
Power Voltage	VCC	-0.5~+7.0	V
Input Voltage	VIN	-0.5~VCC+0.5	V
Output Voltage	VOUT	-0.5~VCC+0.5	V
Input Protection Diode Current	I _{IK}	±20	mA
Output Parasitic Diode Current	I _{OK}	±20	mA
Output Current	I _{OUT}	±25	mA
VCC/GND Current	ICC, IGND	±25	mA
Power Dissipation	P _d	200	mW
Storage Temp.	T _{stg}	-65~+150	°C

CMOS LOGIC IC ELM7S08,ELM7S08B 2-input AND Gate

■ SUGGESTED OPERATING CONDITION

Parameter	Symbol	Value	Units
Power Voltage	VCC	2.0~6.0	V
Input Voltage	VIN	0~VCC	V
Output Voltage	VOUT	0~VCC	V
Operating Temp.	Top	-40~+85	°C
High-input down-time	tr,tf	0~1000 (VCC=2.0V)	ns
		0~500 (VCC=4.5V)	
		0~400 (VCC=6.0V)	

■ DC ELECTRICAL CHARACTERISTICS

Parameter	Sym.	VCC	Top = 25°C			Top = -40~+85°C		Units	Conditions	
			Min.	Typ.	Max.	Min.	Max.			
Input Voltage	VIH	2.0	1.5	-	-	1.5	-	V		
		4.5	3.15	-	-	3.15	-			
		6.0	4.2	-	-	4.2	-			
	VIL	2.0	-	-	0.5	-	0.5	V		
		4.5	-	-	1.35	-	1.35			
		6.0	-	-	1.8	-	1.8			
Output Voltage	VOH	2.0	1.9	2.0	-	1.9	-	V	VIN=VIH	IOH = -20 μA
		4.5	4.4	4.5	-	4.4	-			
		6.0	5.9	6.0	-	5.9	-			
		4.5	4.18	4.36	-	4.13	-			
		6.0	5.68	5.83	-	5.63	-			
	VOL	2.0	-	0.0	0.1	-	0.1	V	VIN=VIH or VIL	IOL = 20 μA
		4.5	-	0.0	0.1	-	0.1			
		6.0	-	0.0	0.1	-	0.1			
		4.5	-	0.12	0.26	-	0.33			
		6.0	-	0.13	0.26	-	0.33			
Input Current	IIN	6.0	-0.1	-	0.1	-1.0	1.0	μA	VIN = VCC or GND	
Static Current	ICC	6.0	-	-	1.0	-	10.0	μA	VIN = VCC or GND	

■ AC ELECTRICAL CHARACTERISTICS

(CL=15pF, tr=tf=6ns, VCC=5V)

Parameter	Sym.	Top = 25°C			Units	Conditions
		Min.	Typ.	Max.		
High Output Down-time	tTLH	-	4	10	ns	Refer to following test circuit
	tTHL	-	3	10		
Propagation Delay-time	tPLH	-	4	15	ns	Refer to following test circuit
	tPHL	-	5	15		

CMOS LOGIC IC ELM7S08,ELM7S08B 2-input AND Gate

(CL=50pF, tr=tf=6ns)

Parameter	Sym.	VCC	Top = 25°C			Top = -40~+85°C		Units	Conditions
			Min.	Typ.	Max.	Min.	Max.		
High-Output Down-time	tTLH	2.0	-	21	125	-	155	ns	Refer to test circuit
		4.5	-	7	25	-	31		
		6.0	-	6	21	-	26		
	tTHL	2.0	-	18	125	-	155	ns	
		4.5	-	6	25	-	31		
		6.0	-	6	21	-	26		
Propagation Delay-time	tPLH	2.0	-	16	100	-	125	ns	Refer to test circuit
		4.5	-	6	20	-	25		
		6.0	-	5	17	-	21		
	tPHL	2.0	-	17	100	-	125	ns	
		4.5	-	8	20	-	25		
		6.0	-	7	17	-	21		
Input Capacity	CIN	-	-	5	10	-	10	pF	
Equivalent Inner Capacity	CPD	-	-	10	-	-	-	pF	

* CPD is IC's inner equivalent capacity which is calculated from non-loaded operating current consumption referred to following test circuit. Averaged operating current consumption at non-load is calculated as following formula;
 $ICC (opr) = CPD \cdot VCC \cdot f_{IN} + ICC$

TEST CIRCUIT

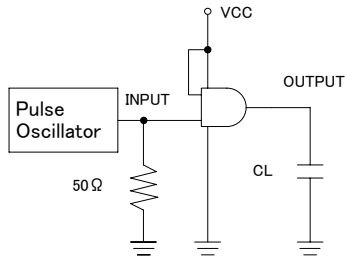

* Output should be opened when measuring current consumption.

MEASURED WAVE PATTERN

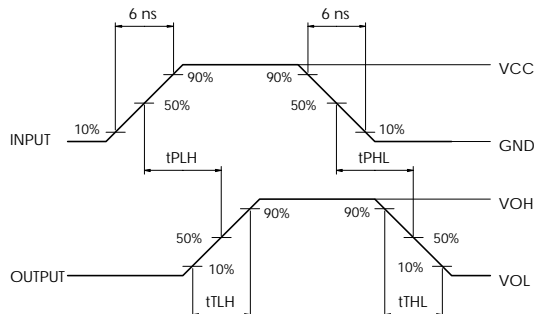

ELM7S02,ELM7S02B 2-input NOR Gate

DESCRIPTION

ELM7S02,ELM7S02B are CMOS 2-input NOR gate ICs. They realize a high speed operation similar to LS-TTL with a lower power consumption by CMOS features. An inner circuit structure of 3-stages logic gates obtains wider noise immunity and constant output.

FEATURES

- Package : SOT-25 package
- Same electrical characteristics as 74HC Series
- Power voltage range : 2.0 ~ 6.0V
- Operation temp. range : -40 ~ +85°C
- | IOH | = IOL = 2mA (min)

PIN CONFIGURATION

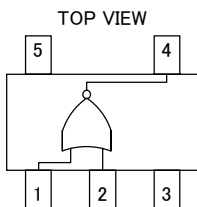

Pin No.	Pin Name
1	INB
2	INA
3	GND
4	OUTX
5	VCC

Input		Output
INA	INB	OUTX
Low	Low	High
Low	High	Low
High	Low	Low
High	High	Low

MARKING

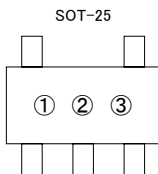

No.	Mark	Contents
①	E	ELM7Sxx, ELM7SxxB series
②	3	ELM7S02, ELM7S02B
③	A~M (excepted I)	Lot No.

MAXIMUM ABSOLUTE RATINGS

Parameter	Symbol	Value	Units
Power Voltage	VCC	-0.5~+7.0	V
Input Voltage	VIN	-0.5~VCC+0.5	V
Output Voltage	VOUT	-0.5~VCC+0.5	V
Input Protection Diode Current	I _{IK}	±20	mA
Output Parasitic Diode Current	I _{OK}	±20	mA
Output Current	I _{OUT}	±25	mA
VCC/GND Current	I _{CC} , I _{GND}	±25	mA
Power Dissipation	P _d	200	mW
Storage Temp.	T _{stg}	-65~+150	°C

CMOS LOGIC IC ELM7S02,ELM7S02B 2-input NOR Gate

■ SUGGESTED OPERATING CONDITION

Parameter	Symbol	Value	Units
Power Voltage	VCC	2.0~6.0	V
Input Voltage	VIN	0~VCC	V
Output Voltage	VOUT	0~VCC	V
Operating Temp.	Top	-40~+85	°C
High-input down-time	tr,tf	0~1000 (VCC=2.0V)	ns
		0~500 (VCC=4.5V)	
		0~400 (VCC=6.0V)	

■ DC ELECTRICAL CHARACTERISTICS

Parameter	Sym.	VCC	Top = 25°C			Top = -40~+85°C		Units	Conditions	
			Min.	Typ.	Max.	Min.	Max.			
Input Voltage	VIH	2.0	1.5	-	-	1.5	-	V		
		4.5	3.15	-	-	3.15	-			
		6.0	4.2	-	-	4.2	-			
	VIL	2.0	-	-	0.5	-	0.5	V		
		4.5	-	-	1.35	-	1.35			
		6.0	-	-	1.8	-	1.8			
Output Voltage	VOH	2.0	1.9	2.0	-	1.9	-	V	VIN=VIL	IOH = -20 μA
		4.5	4.4	4.5	-	4.4	-			
		6.0	5.9	6.0	-	5.9	-			
		4.5	4.18	4.35	-	4.13	-			
	VOL	6.0	5.68	5.83	-	5.63	-	V	VIN=VIH	IOL = 20 μA
		2.0	-	0.0	0.1	-	0.1			
		4.5	-	0.0	0.1	-	0.1			
		6.0	-	0.0	0.1	-	0.1			
		4.5	-	0.12	0.26	-	0.33			
		6.0	-	0.13	0.26	-	0.33			
Input Current	IIN	6.0	-0.1	-	0.1	-1.0	1.0	μA	VIN = VCC or GND	
Static Current	ICC	6.0	-	-	1.0	-	10.0	μA	VIN = VCC or GND	

■ AC ELECTRICAL CHARACTERISTICS

(CL=15pF, tr=tf=6ns, VCC=5V)

Parameter	Sym.	Top = 25°C			Units	Conditions
		Min.	Typ.	Max.		
High Output Down-time	tTLH	-	4	10	ns	Refer to following test circuit
	tTHL	-	3	10		
Propagation Delay-time	tPLH	-	5	15	ns	Refer to following test circuit
	tPHL	-	5	15		

CMOS LOGIC IC ELM7S02,ELM7S02B 2-input NOR Gate

(CL=50pF, tr=tf=6ns)

Parameter	Sym.	VCC	Top = 25°C			Top = -40~+85°C		Units	Conditions
			Min.	Typ.	Max.	Min.	Max.		
High-Output Down-time	tTLH	2.0	-	21	125	-	155	ns	Refer to test circuit
		4.5	-	8	25	-	31		
		6.0	-	7	21	-	26		
	tTHL	2.0	-	16	125	-	155	ns	
		4.5	-	7	25	-	31		
		6.0	-	6	21	-	26		
Propagation Delay-time	tPLH	2.0	-	19	100	-	125	ns	Refer to test circuit
		4.5	-	8	20	-	25		
		6.0	-	7	17	-	21		
	tPHL	2.0	-	17	100	-	125	ns	
		4.5	-	7	20	-	25		
		6.0	-	6	17	-	21		
Input Capacity	CIN	-	-	5	10	-	10	pF	
Equivalent Inner Capacity	CPD	-	-	10	-	-	-	pF	

* CPD is IC's Inner equivalent capacity which is calculated from non-loaded operating current consumption referred to following test circuit. Averaged operating current consumption at non-load is calculated as following formula;

$$ICC (opr) = CPD \cdot VCC \cdot f_{IN} + ICC$$

■ TEST CIRCUIT

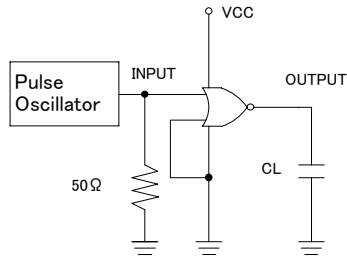

* Output should be opened when measuring current consumption.

■ MEASURED WAVE PATTERN

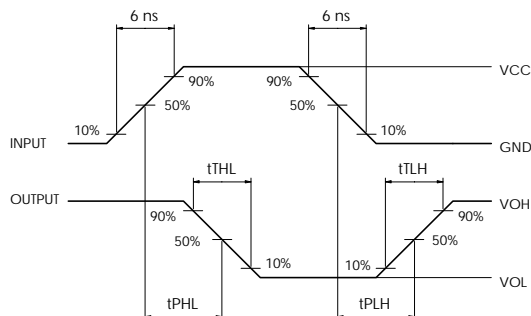

ELM7S32, ELM7S32B 2-input OR Gate

DESCRIPTION

ELM7S32, ELM7S32B are CMOS 2-input OR gate ICs. They realize a high speed operation similar to LS-TTL with a lower power consumption by CMOS features. An inner circuit structure of 3-stages logic gates obtains wider noise immunity and constant output.

FEATURES

- Package : SOT-25 package
- Same electrical characteristics as 74HC Series
- Power voltage range : 2.0 ~ 6.0V
- Operation temp. range : -40 ~ +85°C
- | IOH | = IOL = 2mA (min)

PIN CONFIGURATION

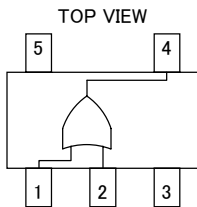

Pin No.	Pin Name
1	INB
2	INA
3	GND
4	OUTX
5	VCC

Input		Output
INA	INB	OUTX
Low	Low	Low
Low	High	High
High	Low	High
High	High	High

MARKING

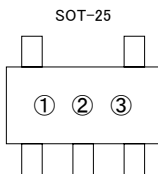

No.	Mark	Contents
①	E	ELM7Sxx, ELM7SxxB series
②	4	ELM7S32, ELM7S32B
③	A~M (excepted I)	Lot No.

MAXIMUM ABSOLUTE RATINGS

Parameter	Symbol	Value	Units
Power Voltage	VCC	-0.5~+7.0	V
Input Voltage	VIN	-0.5~VCC+0.5	V
Output Voltage	VOUT	-0.5~VCC+0.5	V
Input Protection Diode Current	I _{IK}	±20	mA
Output Parasitic Diode Current	I _{OK}	±20	mA
Output Current	I _{OUT}	±25	mA
VCC/GND Current	I _{CC} , I _{GND}	±25	mA
Power Dissipation	P _d	200	mW
Storage Temp.	T _{stg}	-65~+150	°C

CMOS LOGIC IC ELM7S32,ELM7S32B 2-input OR Gate

■ SUGGESTED OPERATING CONDITION

Parameter	Symbol	Value	Units
Power Voltage	VCC	2.0~6.0	V
Input Voltage	VIN	0~VCC	V
Output Voltage	VOUT	0~VCC	V
Operating Temp.	Top	-40~+85	°C
High-input down-time	tr,tf	0~1000 (VCC=2.0V)	ns
		0~500 (VCC=4.5V)	
		0~400 (VCC=6.0V)	

■ DC ELECTRICAL CHARACTERISTICS

Parameter	Sym.	VCC	Top = 25°C			Top = -40~+85°C		Units	Conditions	
			Min.	Typ.	Max.	Min.	Max.			
Input Voltage	VIH	2.0	1.5	-	-	1.5	-	V		
		4.5	3.15	-	-	3.15	-			
		6.0	4.2	-	-	4.2	-			
	VIL	2.0	-	-	0.5	-	0.5	V		
		4.5	-	-	1.35	-	1.35			
		6.0	-	-	1.8	-	1.8			
Output Voltage	VOH	2.0	1.9	2.0	-	1.9	-	V	VIN=	IOH = -20 μA
		4.5	4.4	4.5	-	4.4	-			
		6.0	5.9	6.0	-	5.9	-			
		4.5	4.18	4.36	-	4.13	-			
		6.0	5.68	5.83	-	5.63	-			
	VOL	2.0	-	0.0	0.1	-	0.1	V	VIN=	IOL = 20 μA
		4.5	-	0.0	0.1	-	0.1			
		6.0	-	0.0	0.1	-	0.1			
		4.5	-	0.12	0.26	-	0.33			
		6.0	-	0.16	0.26	-	0.33			
Input Current	IIN	6.0	-0.1	-	0.1	-1.0	1.0	μA	VIN = VCC or GND	
Static Current	ICC	6.0	-	-	1.0	-	10.0	μA	VIN = VCC or GND	

■ AC ELECTRICAL CHARACTERISTICS

(CL=15pF, tr=tf=6ns, VCC=5V)

Parameter	Sym.	Top = 25°C			Units	Conditions
		Min.	Typ.	Max.		
High Output Down-time	tTLH	-	4	10	ns	Refer to following test circuit
	tTHL	-	4	10		
Propagation Delay-time	tPLH	-	5	15	ns	Refer to following test circuit
	tPHL	-	5	15		

CMOS LOGIC IC ELM7S32,ELM7S32B 2-input OR Gate

(CL=50pF, tr=tf=6ns)

Parameter	Sym.	VCC	Top = 25°C			Top = -40~+85°C		Units	Conditions
			Min.	Typ.	Max.	Min.	Max.		
High-Output Down-time	tTLH	2.0	-	22	125	-	155	ns	Refer to test circuit
		4.5	-	7	25	-	31		
		6.0	-	6	21	-	26		
	tTHL	2.0	-	18	125	-	155	ns	
		4.5	-	6	25	-	31		
		6.0	-	6	21	-	26		
Propagation Delay-time	tPLH	2.0	-	17	100	-	125	ns	Refer to test circuit
		4.5	-	7	20	-	25		
		6.0	-	6	17	-	21		
	tPHL	2.0	-	18	100	-	125	ns	
		4.5	-	8	20	-	25		
		6.0	-	7	17	-	21		
Input Capacity	CIN	-	-	5	10	-	10	pF	
Equivalent Inner Capacity	CPD	-	-	10	-	-	-	pF	

* CPD is IC's inner equivalent capacity which is calculated from non-loaded operating current consumption referred to following test circuit. Averaged operating current consumption at non-load is calculated as following formula;
 $ICC (opr) = CPD \cdot VCC \cdot f_{IN} + ICC$

TEST CIRCUIT

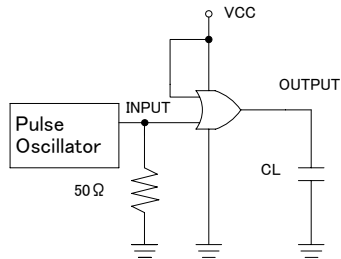

* Output should be opened when measuring current consumption.

MEASURED WAVE PATTERN

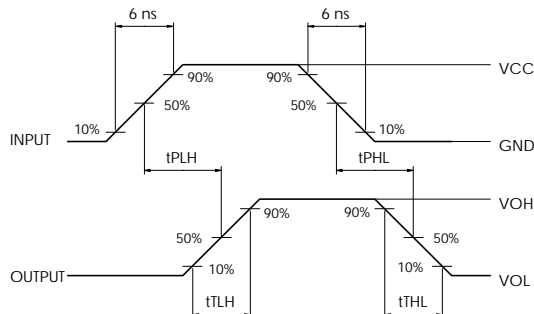

ELM7S04,ELM7S04B Inverter

DESCRIPTION

ELM7S04,ELM7S04B are CMOS inverter ICs. They realizes a high speed operation similar to LS-TTL with a lower power consumption by CMOS features. An inner circuit structure of 3-stages logic gates obtains a wider noise immunity and a constant output.

FEATURES

- Package : SOT-25 package
- Same electrical characteristics as 74HC Series
- Power voltage range : 2.0 ~ 6.0V
- Operation temp. range : -40 ~ +85°C
- | IOH | = IOL = 2mA (min)

PIN CONFIGURATION

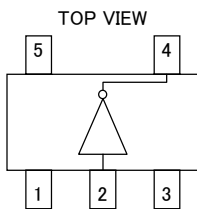

Pin No.	Pin Name
1	NC
2	INY
3	GND
4	OUTX
5	VCC

Input	Output
INA	OUTX
Low	High
High	Low

MARKING

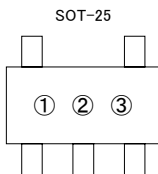

No.	Mark	Contents
①	E	ELM7Sxx, ELM7SxxB series
②	5	ELM7S04, ELM7S04B
③	A~M (excepted I)	Lot No.

MAXIMUM ABSOLUTE RATINGS

Parameter	Symbol	Value	Units
Power Voltage	VCC	-0.5~+7.0	V
Input Voltage	VIN	-0.5~VCC+0.5	V
Output Voltage	VOUT	-0.5~VCC+0.5	V
Input Protection Diode Current	I _{IK}	±20	mA
Output Parasitic Diode Current	I _{OK}	±20	mA
Output Current	I _{OUT}	±25	mA
VCC/GND Current	I _{CC} , I _{GND}	±25	mA
Power Dissipation	P _d	200	mW
Storage Temp.	T _{stg}	-65~+150	°C

CMOS LOGIC IC ELM7S04,ELM7S04B Inverter

■ SUGGESTED OPERATING CONDITION

Parameter	Symbol	Value	Units
Power Voltage	VCC	2.0~6.0	V
Input Voltage	VIN	0~VCC	V
Output Voltage	VOUT	0~VCC	V
Operating Temp.	Top	-40~+85	°C
High-input down-time	tr,tf	0~1000 (VCC=2.0V)	ns
		0~500 (VCC=4.5V)	
		0~400 (VCC=6.0V)	

■ DC ELECTRICAL CHARACTERISTICS

Parameter	Sym.	VCC	Top = 25°C			Top = -40~+85°C		Units	Conditions	
			Min.	Typ.	Max.	Min.	Max.			
Input Voltage	VIH	2.0	1.5	-	-	1.5	-	V		
		4.5	3.15	-	-	3.15	-			
		6.0	4.2	-	-	4.2	-			
	VIL	2.0	-	-	0.5	-	0.5	V		
		4.5	-	-	1.35	-	1.35			
		6.0	-	-	1.8	-	1.8			
Output Voltage	VOH	2.0	1.9	2.0	-	1.9	-	V	VIN=VIL	IOH = -20 μ A
		4.5	4.4	4.5	-	4.4	-			
		6.0	5.9	6.0	-	5.9	-			
		4.5	4.18	4.35	-	4.13	-			
	VOL	6.0	5.68	5.83	-	5.63	-	V	VIN=VIH	IOL = 20 μ A
		2.0	-	0.0	0.1	-	0.1			
		4.5	-	0.0	0.1	-	0.1			
		6.0	-	0.0	0.1	-	0.1			
		4.5	-	0.12	0.26	-	0.33			
		6.0	-	0.13	0.26	-	0.33			
Input Current	IIN	6.0	-0.1	-	0.1	-1.0	1.0	μ A	VIN = VCC or GND	
Static Current	ICC	6.0	-	-	1.0	-	10.0	μ A	VIN = VCC or GND	

■ AC ELECTRICAL CHARACTERISTICS

(CL=15pF, tr=tf=6ns, VCC=5V)

Parameter	Sym.	Top = 25°C			Units	Conditions
		Min.	Typ.	Max.		
High Output Down-time	tTLH	-	4	10	ns	Refer to following test circuit
	tTHL	-	3	10		
Propagation Delay-time	tPLH	-	5	15	ns	Refer to following test circuit
	tPHL	-	5	15		

CMOS LOGIC IC ELM7S04,ELM7S04B Inverter

(CL=50pF, tr=tf=6ns)

Parameter	Sym.	VCC	Top = 25°C			Top = -40~+85°C		Units	Conditions
			Min.	Typ.	Max.	Min.	Max.		
High-Output Down-time	tTLH	2.0	-	22	125	-	155	ns	Refer to test circuit
		4.5	-	8	25	-	31		
		6.0	-	6	21	-	26		
	tTHL	2.0	-	16	125	-	155	ns	
		4.5	-	7	25	-	31		
		6.0	-	6	21	-	26		
Propagation Delay-time	tPLH	2.0	-	18	100	-	125	ns	Refer to test circuit
		4.5	-	8	20	-	25		
		6.0	-	7	17	-	21		
	tPHL	2.0	-	17	100	-	125	ns	
		4.5	-	7	20	-	25		
		6.0	-	6	17	-	21		
Input Capacity	CIN	-	-	5	10	-	10	pF	
Equivalent Inner Capacity	CPD	-	-	10	-	-	-	pF	

* CPD is IC's inner equivalent capacity which is calculated from non-loaded operating current consumption referred to following test circuit. Averaged operating current consumption at non-load is calculated as following formula;

$$ICC (opr) = CPD \cdot VCC \cdot f_{IN} + ICC$$

■ TEST CIRCUIT

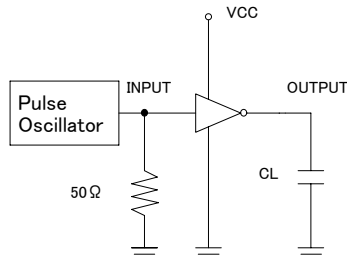

* Output should be opened when measuring current consumption.

■ MEASURED WAVE PATTERN

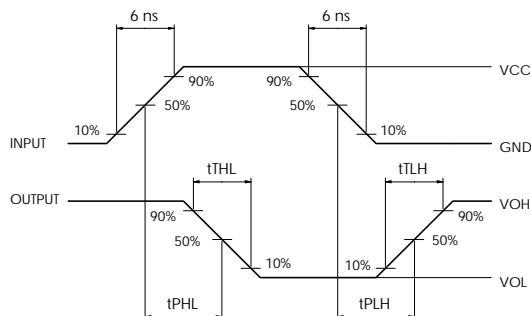

ELM7SU04,ELM7SU04B Unbuffer Inverter

DESCRIPTION

ELM7SU04,ELM7SU04B are CMOS unbuffer inverter ICs. They realize a high speed operation similar to LS-TTL with a lower power consumption by CMOS features.

FEATURES

- Package : SOT-25 package
- Same electrical characteristics as 74HC Series
- Power voltage range : 2.0 ~ 6.0V
- Operation temp. range : -40 ~ +85°C
- | IOH | = IOL = 2mA (min)

PIN CONFIGURATION

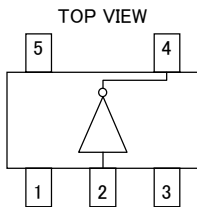

Pin No.	Pin Name
1	NC
2	INY
3	GND
4	OUTX
5	VCC

Input	Output
INA	OUTX
Low	High
High	Low

MARKING

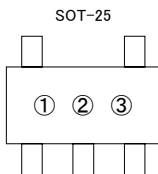

No.	Mark	Contents
①	E	ELM7Sxx, ELM7SxxB series
②	6	ELM7SU04, ELM7SU04B
③	A~M (excepted I)	Lot No.

MAXIMUM ABSOLUTE RATINGS

Parameter	Symbol	Value	Units
Power Voltage	VCC	-0.5~+7.0	V
Input Voltage	VIN	-0.5~VCC+0.5	V
Output Voltage	VOUT	-0.5~VCC+0.5	V
Input Protection Diode Current	I _{IK}	±20	mA
Output Parasitic Diode Current	I _{OK}	±20	mA
Output Current	I _{OUT}	±25	mA
VCC/GND Current	I _{CC} , I _{GND}	±25	mA
Power Dissipation	P _d	200	mW
Storage Temp.	T _{stg}	-65~+150	°C

CMOS LOGIC IC ELM7SU04,ELM7SU04B Unbuffer Inverter

■ SUGGESTED OPERATING CONDITION

Parameter	Symbol	Value	Units
Power Voltage	VCC	2.0~6.0	V
Input Voltage	VIN	0~VCC	V
Output Voltage	VOUT	0~VCC	V
Operating Temp.	Top	-40~+85	°C
High-input down-time	tr,tf	0~1000 (VCC=2.0V)	ns
		0~500 (VCC=4.5V)	
		0~400 (VCC=6.0V)	

■ DC ELECTRICAL CHARACTERISTICS

Parameter	Sym.	VCC	Top = 25°C			Top = -40~+85°C		Units	Conditions	
			Min.	Typ.	Max.	Min.	Max.			
Input Voltage	VIH	2.0	1.7	-	-	1.7	-	V		
		4.5	3.6	-	-	3.6	-			
		6.0	4.8	-	-	4.8	-			
	VIL	2.0	-	-	0.3	-	0.3	V		
		4.5	-	-	0.9	-	0.9			
		6.0	-	-	1.2	-	1.2			
Output Voltage	VOH	2.0	1.8	2.0	-	1.8	-	V	VIN=VIL	IOH = -20 μA
		4.5	4.0	4.5	-	4.0	-			
		6.0	5.5	6.0	-	5.5	-			
		4.5	4.18	4.31	-	4.13	-			
	6.0	5.68	5.80	-	5.63	-			IOH = -2.6mA	
	VOL	2.0	-	0.0	0.2	-	0.2	V	VIN=VIH	IOL = 20 μA
		4.5	-	0.0	0.5	-	0.2			
		6.0	-	0.0	0.5	-	0.5			
		4.5	-	0.17	0.26	-	0.33			
		6.0	-	0.18	0.26	-	0.33			
Input Current	IIN	6.0	-0.1	-	0.1	-1.0	1.0	μA	VIN = VCC or GND	
Static Current	ICC	6.0	-	-	1.0	-	10.0	μA	VIN = VCC or GND	

■ AC ELECTRICAL CHARACTERISTICS

(CL=15pF, tr=tf=6ns,VCC=5V)

Parameter	Sym.	Top = 25°C			Units	Conditions
		Min.	Typ.	Max.		
High Output Down-time	tTLH	-	4	10	ns	Refer to following test circuit
	tTHL	-	3	10		
Propagation Delay-time	tPLH	-	5	15	ns	Refer to following test circuit
	tPHL	-	5	15		

CMOS LOGIC IC ELM7SU04,ELM7SU04B Unbuffer Inverter

(CL=50pF, tr=tf=6ns)

Parameter	Sym.	VCC	Top = 25°C			Top = -40~+85°C		Units	Conditions
			Min.	Typ.	Max.	Min.	Max.		
High-Output Down-time	tTLH	2.0	-	29	125	-	155	ns	Refer to test circuit
		4.5	-	11	25	-	31		
		6.0	-	11	21	-	26		
	tTHL	2.0	-	26	125	-	155	ns	
		4.5	-	9	25	-	31		
		6.0	-	8	21	-	26		
Propagation Delay-time	tPLH	2.0	-	18	100	-	125	ns	Refer to test circuit
		4.5	-	8	20	-	25		
		6.0	-	7	17	-	21		
	tPHL	2.0	-	17	100	-	125	ns	
		4.5	-	7	20	-	25		
		6.0	-	6	17	-	21		
Input Capacity	CIN	-	-	5	10	-	10	pF	
Equivalent Inner Capacity	CPD	-	-	10	-	-	-	pF	

* CPD is IC's inner equivalent capacity which is calculated from non-loaded operating current consumption referred to following test circuit. Averaged operating current consumption at non-load is calculated as following formula;

$$ICC (opr) = CPD \cdot VCC \cdot f_{IN} + ICC$$

TEST CIRCUIT

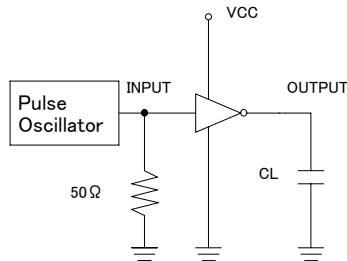

* Output should be opened when measuring current consumption.

MEASURED WAVE PATTERN

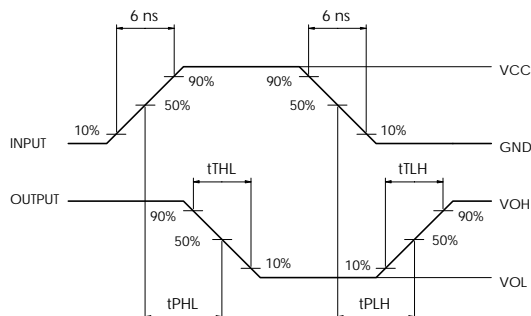

ELM7SU04W, ELM7SU04BW Unbuffer Inverter × 2

DESCRIPTION

ELM7SU04W, ELM7SU04BW are CMOS unbuffer inverter ICs. They realize a high speed operation similar to LS-TTL with a lower power consumption by CMOS features.

FEATURES

- Package : SOT-26 package
- Same electrical characteristics as 74HC Series
- Power voltage range : 2.0 ~ 6.0V
- Operation temp. range : -40 ~ +85°C
- | IOH | = IOL = 2mA (min)

PIN CONFIGURATION

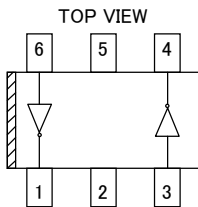

Pin No.	Pin Name
1	OUTA
2	GND
3	INB
4	OUTB
5	VCC
6	INA

Input	Output
INA	OUTA
INB	OUTB
Low	High
High	Low

MARKING

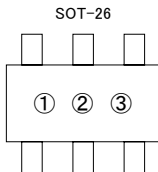

No.	Mark	Contents
①	E	ELM7Sxx, ELM7SxxB series
②	B	ELM7SU04W, ELM7SU04BW
③	A~M (excepted I)	Lot No.

MAXIMUM ABSOLUTE RATINGS

Parameter	Symbol	Value	Units
Power Voltage	VCC	-0.5~+7.0	V
Input Voltage	VIN	-0.5~VCC+0.5	V
Output Voltage	VOUT	-0.5~VCC+0.5	V
Input Protection Diode Current	I _{IK}	±20	mA
Output Parasitic Diode Current	I _{OK}	±20	mA
Output Current	I _{OUT}	±25	mA
VCC/GND Current	I _{CC} , I _{GND}	±25	mA
Power Dissipation	P _d	200	mW
Storage Temp.	T _{stg}	-65~+150	°C

CMOS LOGIC IC ELM7SU04W,ELM7SU04BW Unbuffer Inverter × 2

■ SUGGESTED OPERATING CONDITION

Parameter	Symbol	Value	Units
Power Voltage	VCC	2.0~6.0	V
Input Voltage	VIN	0~VCC	V
Output Voltage	VOUT	0~VCC	V
Operating Temp.	Top	-40~+85	°C
High-input down-time	tr,tf	0~1000 (VCC=2.0V)	ns
		0~500 (VCC=4.5V)	
		0~400 (VCC=6.0V)	

■ DC ELECTRICAL CHARACTERISTICS

Parameter	Sym.	VCC	Top = 25°C			Top = -40~+85°C		Units	Conditions	
			Min.	Typ.	Max.	Min.	Max.			
Input Voltage	VIH	2.0	1.7	-	-	1.7	-	V		
		4.5	3.6	-	-	3.6	-			
		6.0	4.8	-	-	4.8	-			
	VIL	2.0	-	-	0.3	-	0.3	V		
		4.5	-	-	0.9	-	0.9			
		6.0	-	-	1.2	-	1.2			
Output Voltage	VOH	2.0	1.8	2.0	-	1.8	-	V	VIN= VIH or VIL	IOH = -20 μ A
		4.5	4.0	4.5	-	4.0	-			IOH = -2mA
		6.0	5.5	6.0	-	5.5	-			IOH = -2.6mA
		4.5	4.18	4.31	-	4.13	-			
		6.0	5.68	5.80	-	5.63	-			
	VOL	2.0	-	0.0	0.2	-	0.2	V	VIN= VIH	IOL = 20 μ A
		4.5	-	0.0	0.5	-	0.5			IOL = 2mA
		6.0	-	0.0	0.5	-	0.5			IOL = 2.6mA
		4.5	-	0.17	0.26	-	0.33			
		6.0	-	0.18	0.26	-	0.33			
Input Current	IIN	6.0	-0.1	-	0.1	-1.0	1.0	μ A	VIN = VCC or GND	
Static Current	ICC	6.0	-	-	1.0	-	10.0	μ A	VIN = VCC or GND	

■ AC ELECTRICAL CHARACTERISTICS

(CL=15pF, tr=tf=6ns, VCC=5V)

Parameter	Sym.	Top = 25°C			Units	Conditions
		Min.	Typ.	Max.		
High Output Down-time	tTLH	-	5	10	ns	Refer to following test circuit
	tTHL	-	5	10		
Propagation Delay-time	tPLH	-	5	15	ns	Refer to following test circuit
	tPHL	-	5	15		

CMOS LOGIC IC ELM7SU04W,ELM7SU04BW Unbuffer Inverter × 2

(CL=50pF, tr=tf=6ns)

Parameter	Sym.	VCC	Top = 25°C			Top = -40~+85°C		Units	Conditions
			Min.	Typ.	Max.	Min.	Max.		
High-Output Down-time	tTLH	2.0	-	50	125	-	155	ns	Refer to test circuit
		4.5	-	14	25	-	31		
		6.0	-	12	21	-	26		
	tTHL	2.0	-	50	125	-	155	ns	
		4.5	-	14	25	-	31		
		6.0	-	12	21	-	26		
Propagation Delay-time	tPLH	2.0	-	48	100	-	125	ns	Refer to test circuit
		4.5	-	12	20	-	25		
		6.0	-	9	17	-	21		
	tPHL	2.0	-	48	100	-	125	ns	
		4.5	-	12	20	-	25		
		6.0	-	9	17	-	21		
Input Capacity	CIN	-	-	5	10	-	10	pF	
Equivalent Inner Capacity	CPD	-	-	10	-	-	-	pF	

* CPD is IC's inner equivalent capacity which is calculated from non-loaded operating current consumption referred to following test circuit. Averaged operating current consumption at non-load is calculated as following formula;

$$ICC (opr) = CPD \cdot VCC \cdot f_{IN} + ICC$$

■ TEST CIRCUIT

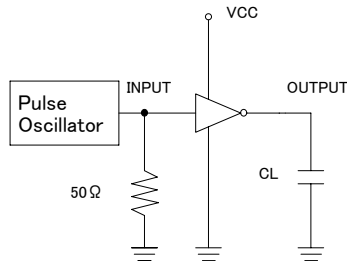

* Output should be opened when measuring current consumption.

■ MEASURED WAVE PATTERN

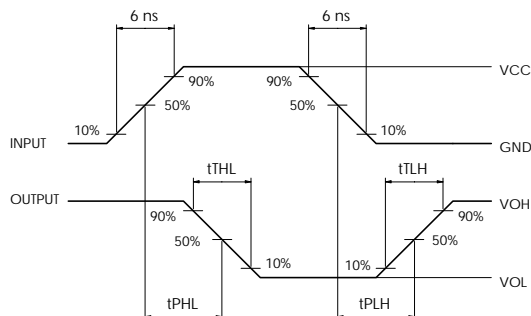

ELM7S86,ELM7S86B 2-input EXCLUSIVE OR Gate

DESCRIPTION

ELM7S86,ELM7S86B are CMOS 2-input EXOR gate ICs. They realize a high speed operation similar to LS-TTL with a lower power consumption by CMOS features. An inner circuit structure of 3-stages logic gates obtains a wider noise immunity and a constant output.

FEATURES

- Package : SOT-25 package
- Same electrical characteristics as 74HC Series
- Power voltage range : 2.0 ~ 6.0V
- Operation temp. range : -40 ~ +85°C
- | IOH | = IOL = 2mA (min)

PIN CONFIGURATION

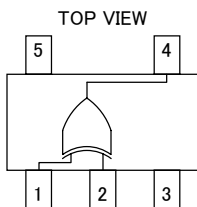

Pin No.	Pin Name
1	INB
2	INA
3	GND
4	OUTX
5	VCC

Input		Output
INA	INB	OUTX
Low	Low	Low
Low	High	High
High	Low	High
High	High	Low

MARKING

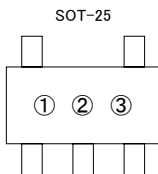

No.	Mark	Contents
①	E	ELM7Sxx, ELM7SxxB series
②	8	ELM7S86, ELM7S86B
③	A~M (excepted I)	Lot No.

MAXIMUM ABSOLUTE RATINGS

Parameter	Symbol	Value	Units
Power Voltage	VCC	-0.5~+7.0	V
Input Voltage	VIN	-0.5~VCC+0.5	V
Output Voltage	VOUT	-0.5~VCC+0.5	V
Input Protection Diode Current	I _{IK}	±20	mA
Output Parasitic Diode Current	I _{OK}	±20	mA
Output Current	I _{OUT}	±25	mA
VCC/GND Current	I _{CC} , I _{GND}	±25	mA
Power Dissipation	P _d	200	mW
Storage Temp.	T _{stg}	-65~+150	°C

CMOS LOGIC ELM7S86,ELM7S86B 2-input EXCLUSIVE OR Gate

■ SUGGESTED OPERATING CONDITION

Parameter	Symbol	Value	Units
Power Voltage	VCC	2.0~6.0	V
Input Voltage	VIN	0~VCC	V
Output Voltage	VOUT	0~VCC	V
Operating Temp.	Top	-40~+85	°C
High-input down-time	tr,tf	0~1000 (VCC=2.0V)	ns
		0~500 (VCC=4.5V)	
		0~400 (VCC=6.0V)	

■ DC ELECTRICAL CHARACTERISTICS

Parameter	Sym.	VCC	Top = 25°C			Top = -40~+85°C		Units	Conditions	
			Min.	Typ.	Max.	Min.	Max.			
Input Voltage	VIH	2.0	1.5	-	-	1.5	-	V		
		4.5	3.15	-	-	3.15	-			
		6.0	4.2	-	-	4.2	-			
	VIL	2.0	-	-	0.5	-	0.5	V		
		4.5	-	-	1.35	-	1.35			
		6.0	-	-	1.8	-	1.8			
Output Voltage	VOH	2.0	1.9	2.0	-	1.9	-	V	VIN=VIH or VIL	IOH = -20 μA
		4.5	4.4	4.5	-	4.4	-			
		6.0	5.9	6.0	-	5.9	-			
		4.5	4.18	4.31	-	4.13	-			
		6.0	5.68	5.80	-	5.63	-			
	VOL	2.0	-	0.0	0.1	-	0.1	V	VIN=VIH	IOL = 20 μA
		4.5	-	0.0	0.1	-	0.1			
		6.0	-	0.0	0.1	-	0.1			
		4.5	-	0.17	0.26	-	0.33			
		6.0	-	0.18	0.26	-	0.33			
Input Current	IIN	6.0	-0.1	-	0.1	-1.0	1.0	μA	VIN = VCC or GND	
Static Current	ICC	6.0	-	-	1.0	-	10.0	μA	VIN = VCC or GND	

■ AC ELECTRICAL CHARACTERISTICS

(CL=15pF, tr=tf=6ns, VCC=5V)

Parameter	Sym.	Top = 25°C			Units	Conditions
		Min.	Typ.	Max.		
High Output Down-time	tTLH	-	7	10	ns	Refer to following test circuit
	tTHL	-	7	10		
Propagation Delay-time	tPLH	-	9	20	ns	Refer to following test circuit
	tPHL	-	9	20		

CMOS LOGIC ELM7S86,ELM7S86B 2-input EXCLUSIVE OR Gate

(CL=50pF, tr=tf=6ns)

Parameter	Sym.	VCC	Top = 25°C			Top = -40~+85°C		Units	Conditions
			Min.	Typ.	Max.	Min.	Max.		
High-Output Down-time	tTLH	2.0	-	50	125	-	155	ns	Refer to test circuit
		4.5	-	14	25	-	31		
		6.0	-	12	21	-	26		
	tTHL	2.0	-	50	125	-	155	ns	
		4.5	-	14	25	-	31		
		6.0	-	12	21	-	26		
Propagation Delay-time	tPLH	2.0	-	60	135	-	170	ns	Refer to test circuit
		4.5	-	16	27	-	34		
		6.0	-	10	22	-	28		
	tPHL	2.0	-	60	135	-	170	ns	
		4.5	-	16	27	-	34		
		6.0	-	10	22	-	28		
Input Capacity	CIN	-	-	5	10	-	10	pF	
Equivalent Inner Capacity	CPD	-	-	10	-	-	-	pF	

* CPD is IC's inner equivalent capacity which is calculated from non-loaded operating current consumption referred to following test circuit. Averaged operating current consumption at non-load is calculated as following formula;
 $ICC (opr) = CPD \cdot VCC \cdot f_{IN} + ICC$

TEST CIRCUIT

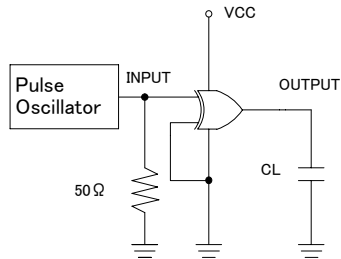

* Output should be opened when measuring current consumption.

MEASURED WAVE PATTERN

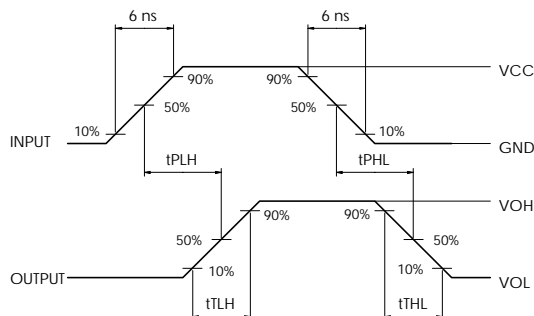

ELM7S66,ELM7S66B Analog Switch

DESCRIPTION

ELM7S66,ELM7S66B are CMOS analog switches. They realize a high speed operation with low power consumption by CMOS features. With a low on resistance and a high transmission rate, they realize a wider input voltage range.

FEATURES

- Package : SOT-25 package
- Same electrical characteristics as 74HC Series
- Power voltage range : 2.0 ~ 6.0V
- Operation temp. range : -40 ~ +85°C
- | IOH | = IOL = 2mA (min)

PIN CONFIGURATION

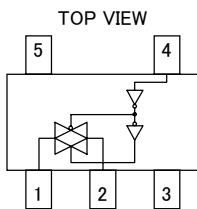

Pin No.	Pin Name
1	IN/OUT
2	OUT/IN
3	GND
4	Control
5	VCC

Control	Switch
Low	OFF
High	ON

MARKING

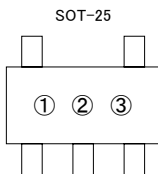

No.	Mark	Contents
①	E	ELM7Sxx, ELM7SxxB series
②	9	ELM7S66, ELM7S66B
③	A~M (excepted I)	Lot No.

MAXIMUM ABSOLUTE RATINGS

Parameter	Symbol	Value	Units
Power Voltage	VCC	-0.5~+7.0	V
Input Voltage	VIN	-0.5~VCC+0.5	V
Output Voltage	VOUT	-0.5~VCC+0.5	V
Input Protection Diode Current	I _{IK}	±20	mA
Output Parasitic Diode Current	I _{OK}	±20	mA
Output Current	I _{OUT}	±25	mA
VCC/GND Current	I _{CC} , I _{GND}	±25	mA
Power Dissipation	P _d	200	mW
Storage Temp.	T _{stg}	-65~+150	°C

CMOS LOGIC IC ELM7S66,ELM7S66B Analog Switch

■ SUGGESTED OPERATING CONDITION

Parameter	Symbol	Value	Units
Power Voltage	VCC	2.0~6.0	V
Input Voltage	VIN	0~VCC	V
Output Voltage	VOUT	0~VCC	V
Operating Temp.	Top	-40~+85	°C
High-input down-time	tr,tf	0~1000 (VCC=2.0V)	ns
		0~500 (VCC=4.5V)	
		0~400 (VCC=6.0V)	

■ DC ELECTRICAL CHARACTERISTICS

Parameter	Sym.	VCC	Top = 25°C			Top = -40~+85°C		Units	Conditions
			Min.	Typ.	Max.	Min.	Max.		
Input Voltage	VIH	2.0	1.5	-	-	1.5	-	V	
		4.5	3.15	-	-	3.15	-		
		6.0	4.2	-	-	4.2	-		
	VIL	2.0	-	-	0.5	-	0.5	V	
		4.5	-	-	1.35	-	1.35		
		6.0	-	-	1.8	-	1.8		
ON-Resistor	RON	2.0	-	2000	5000	-	6250	Ω	VCONT=VIH VIN=0~VCC IIN/OUT=1mA
		4.5	-	100	200	-	250		
		6.0	-	60	170	-	210		
SW-Off Leak-Current	IS (Off)	6.0	-0.1	-	0.1	-1.0	1.0	μA	VCONT=VIL VIN=VCC, VOUT=GND
SW-ON Leak-Current	IS (On)	6.0	-0.1	-	0.1	-1.0	1.0	μA	VCONT=VIH VIN = VCC or GND
Cont Input Current	ICONT	6.0	-0.1	-	0.1	-1.0	1.0	μA	VIN = VCC or GND
Static Current	ICC	6.0	-	-	1.0	-	10.0	μA	VIN = VCC or GND

CMOS LOGIC IC ELM7S66,ELM7S66B Analog Switch

■ AC ELECTRICAL CHARACTERISTICS

($t_r=t_f=6ns$)

Parameter	Sym.	VCC	Ta = 25°C			Ta = -40~+85°C		Units	Conditions
			Min.	Typ.	Max.	Min.	Max.		
Propagation Delay-time	tPLH	2.0	-	-	50	-	65	ns	CL=50pF RL=10kΩ
		3.3	-	4	10	-	13		
	tPHL	5.0	-	-	9	-	11		
Output Enable-Time	tZL	2.0	-	-	115	-	145	ns	CL=50pF RL=1kΩ
		3.3	-	10	23	-	29		
	tZH	5.0	-	-	20	--	25		
Output Disable-Time	tLZ	2.0	-	-	115	-	145	ns	CL=50pF RL=1kΩ
		4.5	-	14	23	-	29		
	tHZ	6.0	-	-	20	--	25		
Maximum Control Input Frequency	fIN	2.0	-	20	-	-	-	MHz	RL=1kΩ CL=15pF VOUT=VCC/2
		4.5	-	30	-	-	-		
		6.0	-	30	-	-	-		
Control Input Capacity	CIN	-	-	5	10	-	10	pF	
SW-Input/Output Capacity	CIN/OUT	-	-	6	-	-	-	pF	
Feed-Through Capacity	CIN-OUT	-	-	0.5	-	-	-	pF	Refer to test circuit
Equivalent Inner Capacity	CPD	-	-	13	-	-	-	pF	

* CPD is IC's inner equivalent capacity which is calculated from non-loaded operating current consumption referred to following test circuit. Averaged operating current consumption at non-load is calculated as following formula;

$$ICC (opr) = CPD \cdot VCC \cdot fIN + ICC$$

CMOS LOGIC IC ELM7S66,ELM7S66B Analog Switch

■ TEST CIRCUIT

● RON : ON Resister

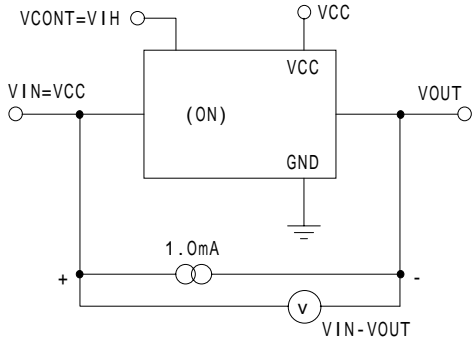

$$R_{ON} = \frac{V_{IN} - V_{OUT}}{10^{-3}} (\Omega)$$

● IS(OFF) : SW-OFF leak, IS(ON) : SW-ON leak Current

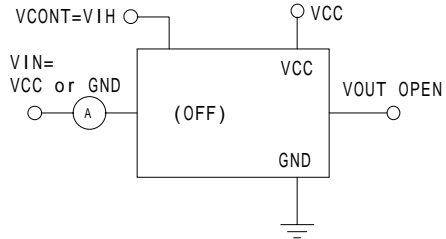
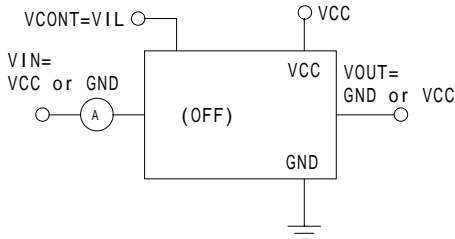

● tPLH, tPHL : Propagation delay-time (SW-input → SW-output)

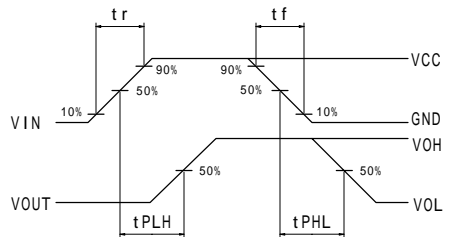
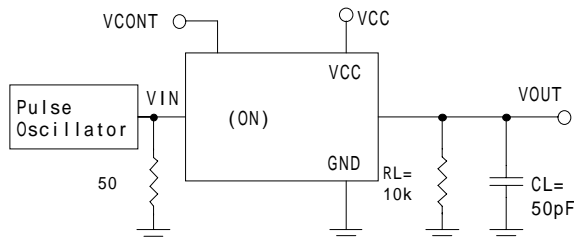

● **t_{ZH}, t_{ZL}/t_{HZ}, t_{LZ} : Output enable, Output disable time**

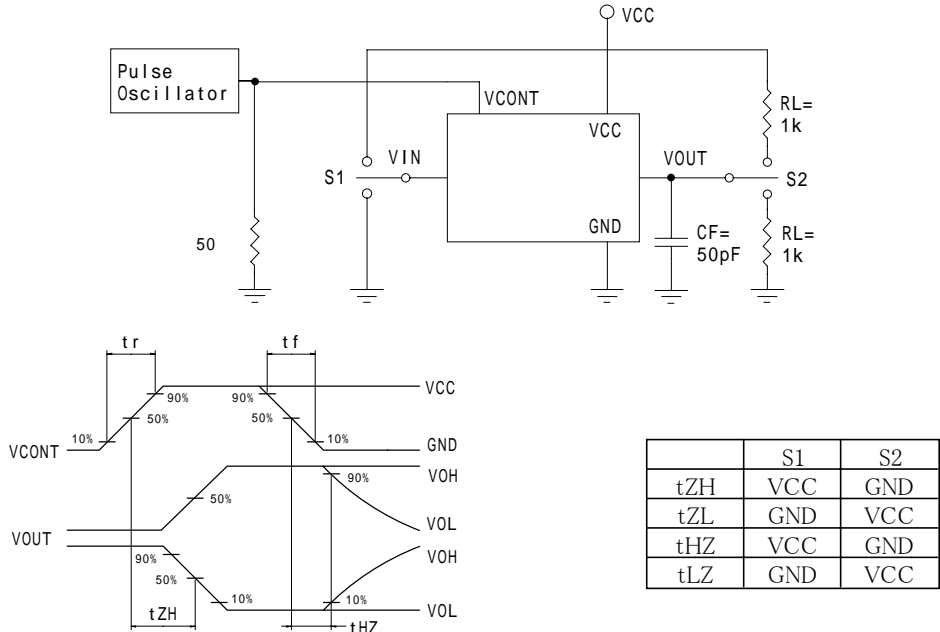

● **Maximum controlled input frequency**

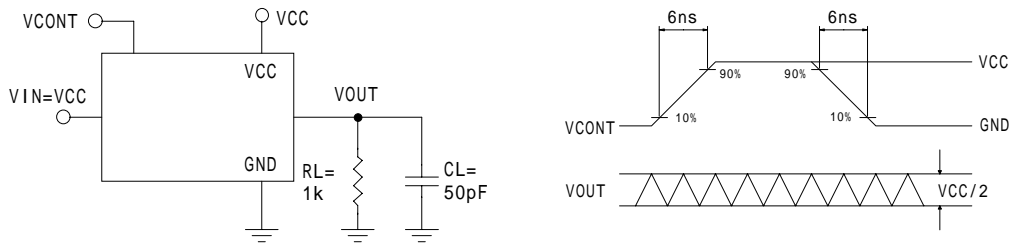

● **Feed-through capacity**

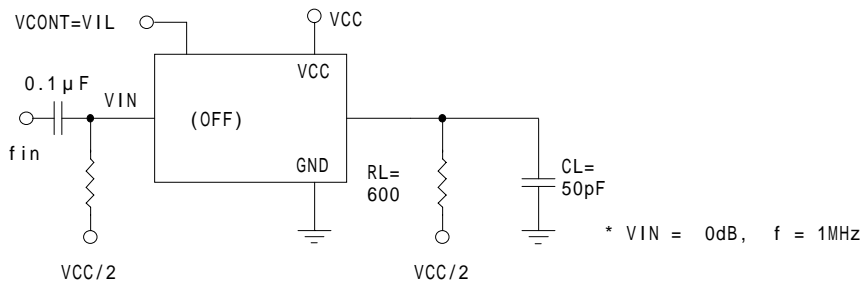

ELM7S14,ELM7S14B SCHMITT Inverter

DESCRIPTION

ELM7S14,ELM7S14B are CMOS schmitt inverter ICs. They realizes a high speed operation similar to LS-TTL with a lower power consumption by CMOS features. An inner circuit structure of 3-stages logic gates obtains a wider noise immunity and a constant output.

FEATURES

- Package : SOT-25 package
- Same electrical characteristics as 74HC Series
- Power voltage range : 2.0 ~ 6.0V
- Operation temp. range : -40 ~ +85°C
- | IOH | = IOL = 2mA (min)

PIN CONFIGURATION

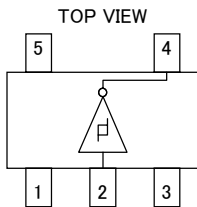

Pin No.	Pin Name
1	NC
2	INY
3	GND
4	OUTX
5	VCC

Input	Output
INA	OUTX
Low	High
High	Low

MARKING

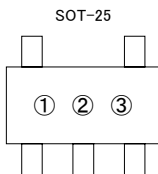

No.	Mark	Contents
①	E	ELM7Sxx, ELM7SxxB series
②	A	ELM7S14, ELM7S14B
③	A~M (excepted I)	Lot No.

MAXIMUM ABSOLUTE RATINGS

Parameter	Symbol	Value	Units
Power Voltage	VCC	-0.5~+7.0	V
Input Voltage	VIN	-0.5~VCC+0.5	V
Output Voltage	VOUT	-0.5~VCC+0.5	V
Input Protection Diode Current	I _{IK}	±20	mA
Output Parasitic Diode Current	I _{OK}	±20	mA
Output Current	I _{OUT}	±25	mA
VCC/GND Current	ICC, IGND	±25	mA
Power Dissipation	P _d	200	mW
Storage Temp.	T _{stg}	-65~+150	°C

CMOS LOGIC IC ELM7S14,ELM7S14B SCHMITT Inverter

■ SUGGESTED OPERATING CONDITION

Parameter	Symbol	Value	Units
Power Voltage	VCC	2.0~6.0	V
Input Voltage	VIN	0~VCC	V
Output Voltage	VOUT	0~VCC	V
Operating Temp.	Top	-40~+85	°C
High-input down-time	tr,tf	0~1000 (VCC=2.0V)	ns
		0~500 (VCC=4.5V)	
		0~400 (VCC=6.0V)	

■ DC ELECTRICAL CHARACTERISTICS

Parameter	Sym.	VCC	Top = 25°C			Top = -40~+85°C		Units	Conditions	
			Min.	Typ.	Max.	Min.	Max.			
Threshold Voltage	Vt+	2.0	-	-	1.5	-	1.5	V		
		4.5	-	-	3.15	-	3.15			
		6.0	-	-	4.2	-	4.2			
	Vt-	2.0	0.3	-	-	0.3	-	V		
		4.5	0.9	-	-	0.9	-			
		6.0	1.2	-	-	1.2	-			
Hysteresis Voltage	Vh	2.0	0.2	-	1.2	0.2	1.2	V		
		4.5	0.4	-	2.25	0.4	2.25			
		6.0	0.6	-	3.0	0.6	3.0			
Output Voltage	VOH	2.0	1.9	2.0	-	1.9	-	V	VIN=VIH or VIL	IOH = -20 μA IOH = -2mA IOH = -2.6mA
		4.5	4.4	4.5	-	4.4	-			
		6.0	5.9	6.0	-	5.9	-			
		4.5	4.18	4.31	-	4.13	-			
		6.0	5.68	5.80	-	5.63	-			
	VOL	2.0	-	0.0	0.1	-	0.1	V	VIN=VIH	IOL = 20 μA IOL = 2mA IOL = 2.6mA
		4.5	-	0.0	0.1	-	0.1			
		6.0	-	0.0	0.1	-	0.1			
		4.5	-	0.17	0.26	-	0.33			
		6.0	-	0.18	0.26	-	0.33			
Input Current	IIN	6.0	-0.1	-	0.1	-1.0	1.0	μA	VIN = VCC or GND	
Static Current	ICC	6.0	-	-	1.0	-	10.0	μA	VIN = VCC or GND	

CMOS LOGIC IC ELM7S14,ELM7S14B SCHMITT Inverter

■ AC ELECTRICAL CHARACTERISTICS

(CL=15pF, tr=tf=6ns,VCC=5V)

Parameter	Sym.	Top = 25°C			Units	Conditions
		Min.	Typ.	Max.		
High Output Down-time	tTLH	-	5	10	ns	Refer to following test circuit
	tTHL	-	5	10		
Propagation Delay-time	tPLH	-	7	15	ns	Refer to following test circuit
	tPHL	-	7	15		

(CL=50pF, tr=tf=6ns)

Parameter	Sym.	VCC	Top = 25°C			Top = -40~+85°C		Units	Conditions
			Min.	Typ.	Max.	Min.	Max.		
High-Output Down-time	tTLH	2.0	-	50	125	-	155	ns	Refer to test circuit
		4.5	-	14	25	-	31		
		6.0	-	12	21	-	26		
	tTHL	2.0	-	50	125	-	155	ns	
		4.5	-	14	25	-	31		
		6.0	-	12	21	-	26		
Propagation Delay-time	tPLH	2.0	-	48	100	-	125	ns	Refer to test circuit
		4.5	-	12	20	-	25		
		6.0	-	9	17	-	21		
	tPHL	2.0	-	48	100	-	125	ns	
		4.5	-	12	20	-	25		
		6.0	-	9	17	-	21		
Input Capacity	CIN	-	-	5	10	-	10	pF	
Equivalent Inner Capacity	CPD	-	-	10	-	-	-	pF	

* CPD is IC's inner equivalent capacity which is calculated from non-loaded operating current consumption referred to following test circuit. Averaged operating current consumption at non-load is calculated as following formula;

$$ICC (opr) = CPD \cdot VCC \cdot fIN + ICC$$

CMOS LOGIC IC ELM7S14,ELM7S14B SCHMITT Inverter

■ TEST CIRCUIT

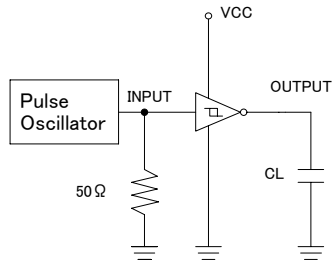

* Output should be opened when measuring current consumption.

■ MEASURED WAVE PATTERN

