

ELM98xxxA VOLTAGE REGULATOR

■ GENERAL DESCRIPTION

ELM98xxxA Series is a CMOS Voltage Regulator. It consists of reference voltage, error amplifier, short-protected control transistor, output voltage setting resistor, and so on. Output voltage is fixed internally with high accuracy.

Two package types are available, SOT-89 and SOT-23.

■ FEATURES

- High accuracy : $\pm 2.0\%$
- Load stability : TYP. 10mV ($1\text{mA} \leq \text{IOUT} \leq 50\text{mA}$)
- Input stability : TYP. 0.1%/V at $\text{IOUT}=50\text{mA}$
- Output voltage temperature coefficient : $\pm 100\text{ppm}/^\circ\text{C}$
- Very low power operation : TYP. 4.0 μ A (ELM9830xA)
- Very small package : SOT-89, SOT-23

■ APPLICATION

- Battery-operated devices
- Palmtops
- Cameras and Video recorders
- Reference voltage sources

■ PIN CONFIGURATION

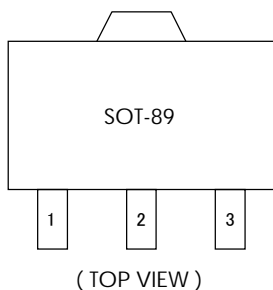

Pin No.	Pin Name
1	VSS
2	VIN
3	VOUT

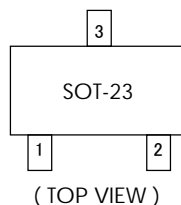

Pin No.	Pin Name
1	VSS
2	VOUT
3	VIN

VOLTAGE REGULATOR ELM98xxxA

SELECTION GUIDE

Symbol		
a, b	Output Voltage	Ex 27 : VOUT = 2.7V 30 : VOUT = 3.0V 50 : VOUT = 5.0V
c	Package	A : SOT-89 B : SOT-23
d	Product Version	A : A Version

ELM98 x x x A
 ↑ ↑ ↑ ↑
 a b c d

SERIES

Model	Output Voltage	Package	Model	Output Voltage	Package
ELM9827BA-S(N)	2.7V	SOT-23	ELM9827AA-S(N)	2.7V	SOT-89
ELM9830BA-S(N)	3.0V	SOT-23	ELM9830AA-S(N)	3.0V	SOT-89
ELM9833BA-S(N)	3.3V	SOT-23	ELM9833AA-S(N)	3.3V	SOT-89
ELM9850BA-S(N)	5.0V	SOT-23	ELM9850AA-S(N)	5.0V	SOT-89

S type : Standard, N type : Reverse

* Available 1.2V~6.0V output voltage at 0.1V step as semi-custom-made IC

MARKING

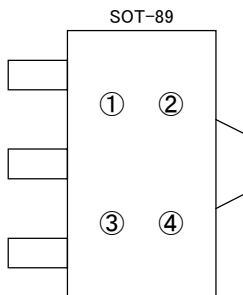

① : Represents the decimal digit of the Output Voltage

Symbol	Output Voltage	Symbol	Output Voltage
0	*.0V	5	*.5V
1	*.1V	6	*.6V
2	*.2V	7	*.7V
3	*.3V	8	*.8V
4	*.4V	9	*.9V

② : Represents the integer digit of the Output Voltage

Symbol	Output Voltage	Symbol	Output Voltage
A	2.*V	D	5.*V
B	3.*V	E	6.*V
C	4.*V	F	1.*V

③ : Represents the assembly lot number
A ~ Z repeated (I,O,X excepted)

④ : Represents the assembly lot number
0 ~ 9 repeated

VOLTAGE REGULATOR ELM98xxxA

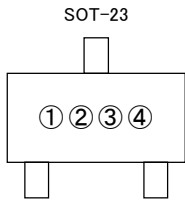

① : Represents the integer digit of the Output Voltage

Symbol	Output Voltage	Symbol	Output Voltage
2	2.*V	5	5.*V
3	3.*V	6	6.*V
4	4.*V	1	1.*V

② : Represents the decimal digit of the Output Voltage

Symbol	Detection Voltage	Symbol	Detection Voltage
0	*.0V	5	*.5V
1	*.1V	6	*.6V
2	*.2V	7	*.7V
3	*.3V	8	*.8V
4	*.4V	9	*.9V

③ : Represents the assembly lot number
A ~ Z repeated (I,O,X excepted)

④ : Represents the assembly lot number
0 ~ 9 repeated

■ BLOCK DIAGRAM

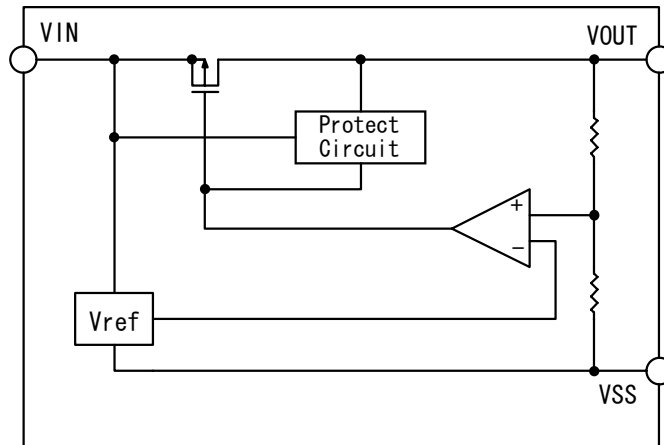

■ STANDARD CIRCUIT

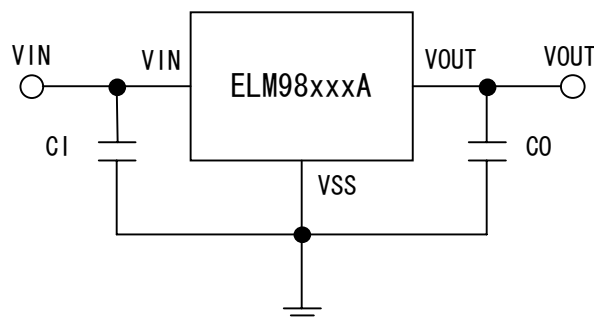

VOLTAGE REGULATOR ELM98xxxA

■ MAXIMUM ABSOLUTE RATINGS

Parameter	Symbol	Limits	Units
Input Voltage	VIN	12	V
Output Voltage	VOUT	VIN+0.3~VSS-0.3	V
Output Current	IOUT	200	mA
Power Dissipation	Pd	SOT-89	300
		SOT-23	200
Operating Temperature	Top	-30~+80	°C
Storage Temperature	Tstg	-40~+125	

* Output current must not exceed power dissipation specified in Maximum Absolute Ratings.

■ ELECTRICAL CHARACTERISTICS

ELM9827xA

(Top=25°C)

Parameter	Symbol	Conditions	Min.	Typ.	Max.	Units
Output Voltage	VOUT	VIN=4.7V, IOUT=1mA	2.646	2.700	2.754	V
Output Current	IOUT	VIN=3.3V	40			mA
Load Stability	$\frac{\Delta V_{OUT}}{\Delta I_{OUT}}$	VIN=4.7V 1mA ≤ IOUT ≤ 50mA		10	20	mV
	Vdif	IOUT=10mA		90	120	mV
Current Consumption	ISS	VIN=4.7V, No-load		4.0	7.0	μA
Input Stability	$\frac{\Delta V_{OUT}}{\Delta V_{IN}}$	3.7V ≤ VIN ≤ 6.7V IOUT=50mA		0.1	0.25	%/V
	VIN				10	V
Output Voltage Temperature Characteristics	$\frac{\Delta V_{OUT}}{\Delta T_{top}}$	VIN=4.7V, IOUT=1mA -30°C ≤ Top ≤ +80°C		±100		ppm/°C

VOLTAGE REGULATOR ELM98xxxA

ELM9830xA

(Top=25°C)

Parameter	Symbol	Conditions	Min.	Typ.	Max.	Units
Output Voltage	VOUT	VIN=5.0V, IOU=1mA	2.940	3.000	3.060	V
Output Current	IOU	VIN=3.6V	50			mA
Load Stability	$\frac{\Delta V_{OUT}}{\Delta I_{OUT}}$	VIN=5.0V 1mA ≤ IOU ≤ 50mA		10	20	mV
Input/Output Voltage Differential	Vdif	IOU=10mA		85	115	mV
Current Consumption	ISS	VIN=5.0V, No-load		4.0	7.0	μA
Input Stability	$\frac{\Delta V_{OUT}}{\Delta V_{IN}}$	4.0V ≤ VIN ≤ 7.0V IOU=50mA		0.1	0.25	%/V
Input Voltage	VIN				10	V
Output Voltage Temperature Characteristics	$\frac{\Delta V_{OUT}}{\Delta T_{top}}$	VIN=5.0V, IOU=1mA -30°C ≤ Top ≤ +80°C		±100		ppm/°C

ELM9833xA

(Top=25°C)

Parameter	Symbol	Conditions	Min.	Typ.	Max.	Units
Output Voltage	VOUT	VIN=5.3V, IOU=1mA	3.234	3.300	3.366	V
Output Current	IOU	VIN=3.9V	55			mA
Load Stability	$\frac{\Delta V_{OUT}}{\Delta I_{OUT}}$	VIN=5.3V 1mA ≤ IOU ≤ 50mA		10	20	mV
Input/Output Voltage Differential	Vdif	IOU=10mA		80	110	mV
Current Consumption	ISS	VIN=5.3V, No-load		4.5	8.0	μA
Input Stability	$\frac{\Delta V_{OUT}}{\Delta V_{IN}}$	4.3V ≤ VIN ≤ 7.3V IOU=50mA		0.1	0.25	%/V
Input Voltage	VIN				10	V
Output Voltage Temperature Characteristics	$\frac{\Delta V_{OUT}}{\Delta T_{top}}$	VIN=5.3V, IOU=1mA -30°C ≤ Top ≤ +80°C		±100		ppm/°C

ELM9850xA

(Top=25°C)

Parameter	Symbol	Conditions	Min.	Typ.	Max.	Units
Output Voltage	VOUT	VIN=7.0V, IOU=1mA	4.900	5.000	5.100	V
Output Current	IOU	VIN=5.6V	70			mA
Load Stability	$\frac{\Delta V_{OUT}}{\Delta I_{OUT}}$	VIN=7.0V 1mA ≤ IOU ≤ 50mA		10	20	mV
Input/Output Voltage Differential	Vdif	IOU=10mA		55	85	mV
Current Consumption	ISS	VIN=7.0V, No-load		5.0	9.0	μA
Input Stability	$\frac{\Delta V_{OUT}}{\Delta V_{IN}}$	6.0V ≤ VIN ≤ 9.0V IOU=50mA		0.1	0.25	%/V
Input Voltage	VIN				10	V
Output Voltage Temperature Characteristics	$\frac{\Delta V_{OUT}}{\Delta T_{top}}$	VIN=7.0V, IOU=1mA -30°C ≤ Top ≤ +80°C		±100		ppm/°C

VOLTAGE REGULATOR ELM98xxxA

TYPICAL CHARACTERISTICS

● ELM9827xA

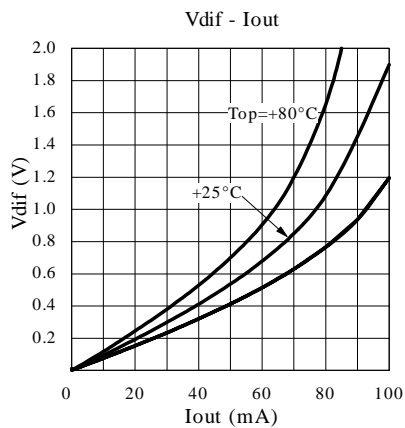
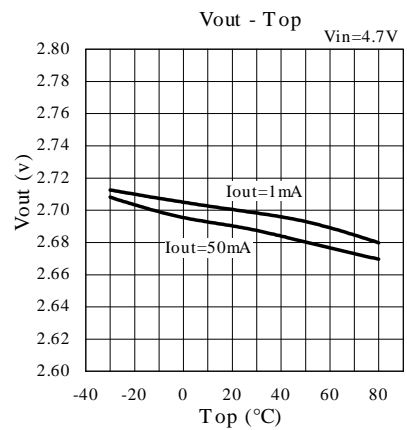
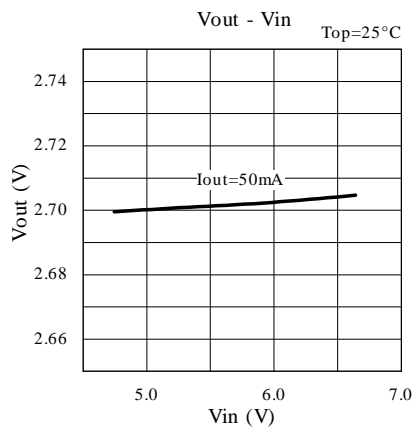
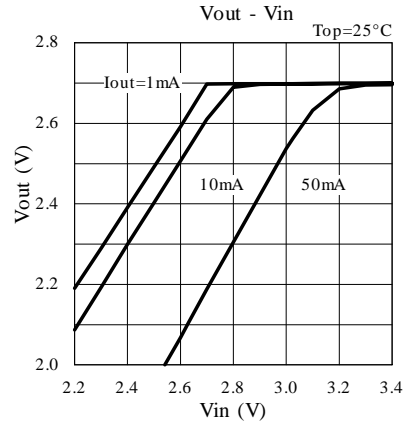
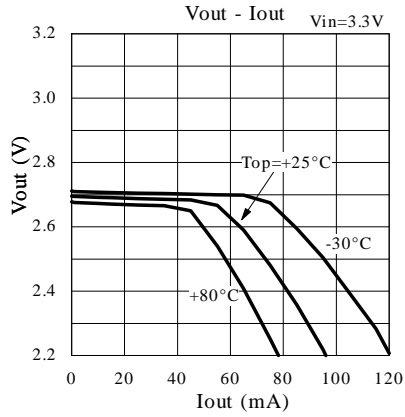

VOLTAGE REGULATOR ELM98xxxA

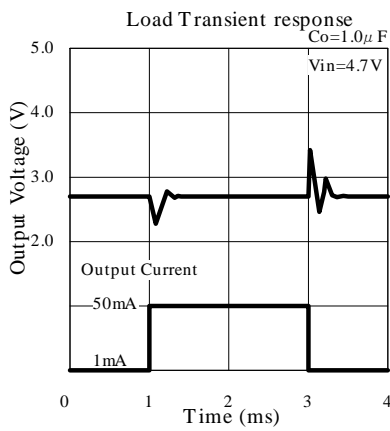
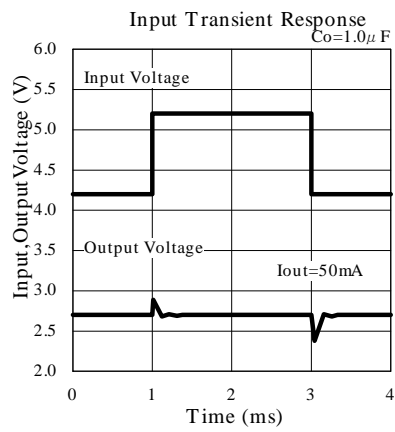
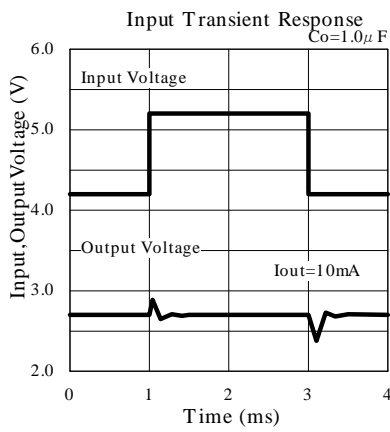
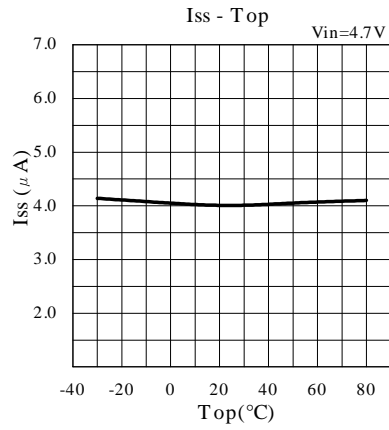
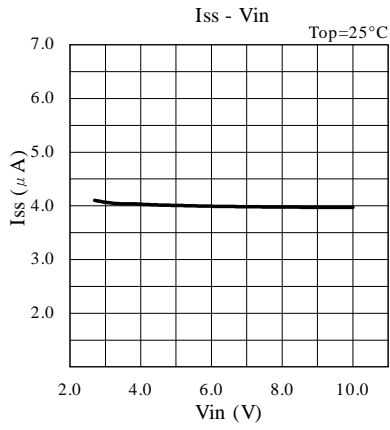

VOLTAGE REGULATOR ELM98xxxA

● ELM9830xA

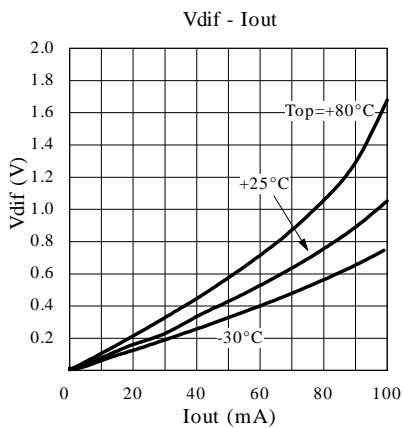
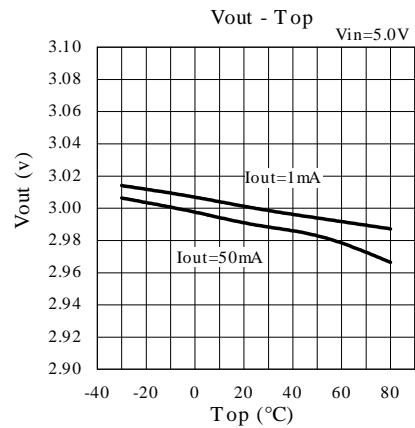
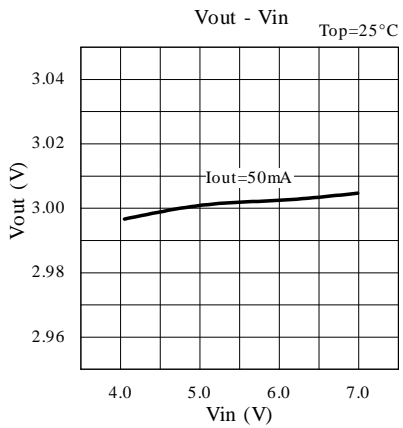
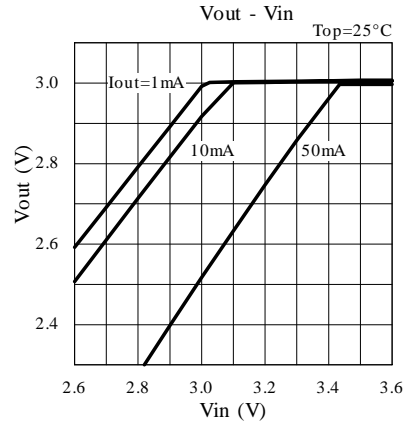
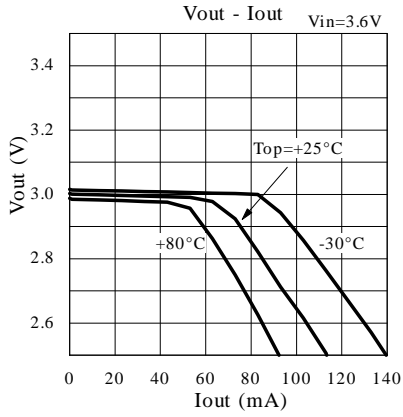

VOLTAGE REGULATOR ELM98xxxA

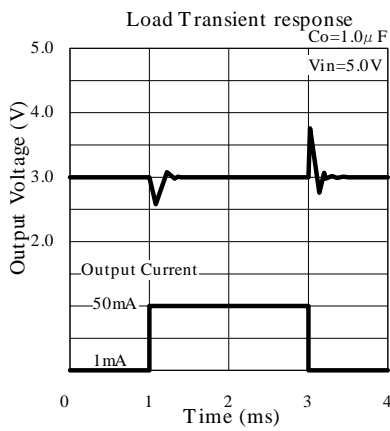
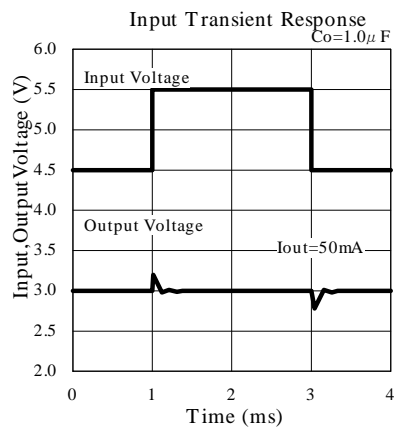
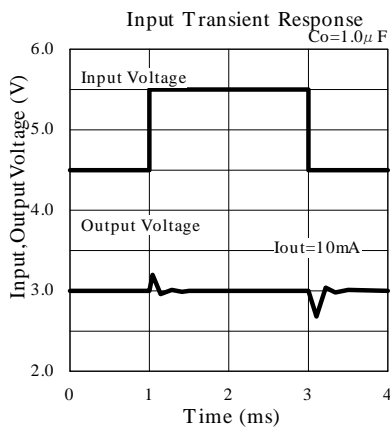
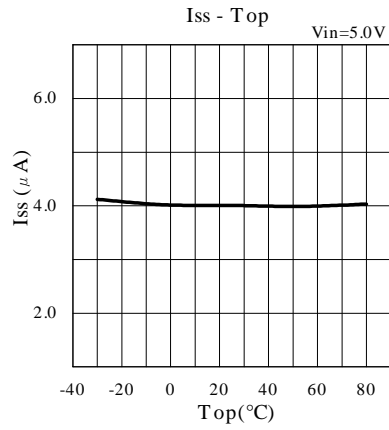
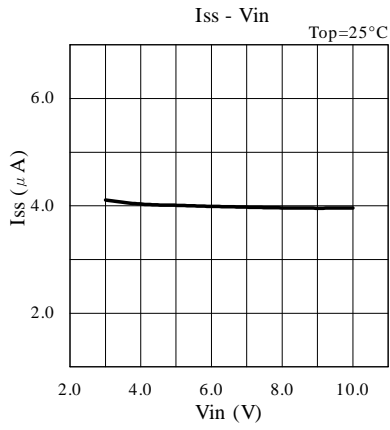

VOLTAGE REGULATOR ELM98xxxA

● ELM9833xA

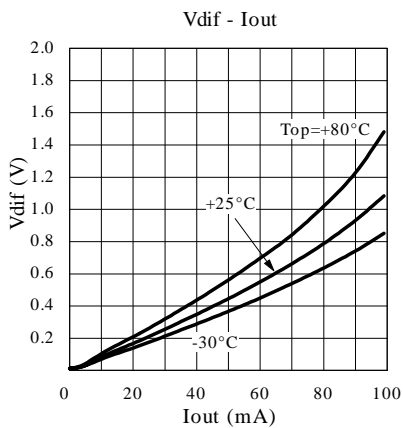
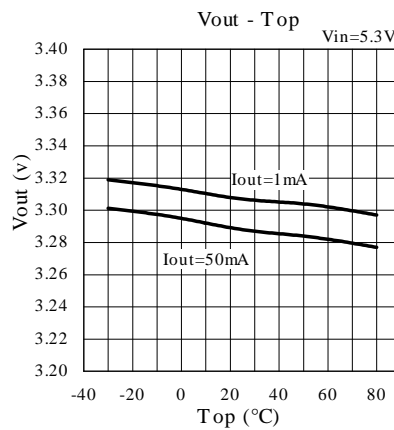
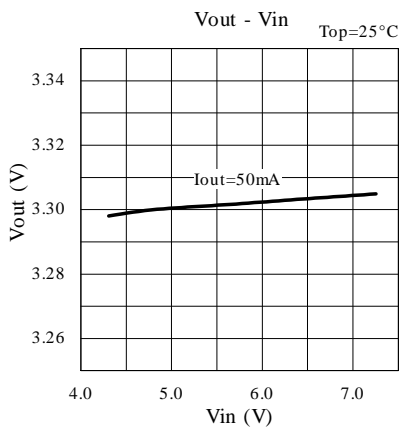
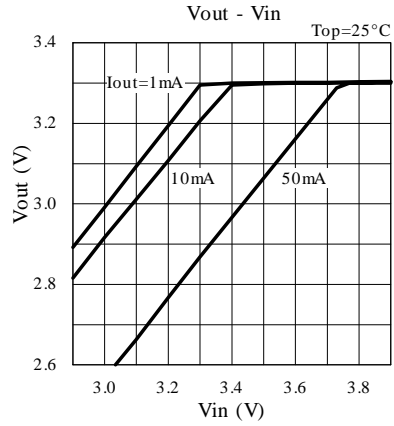
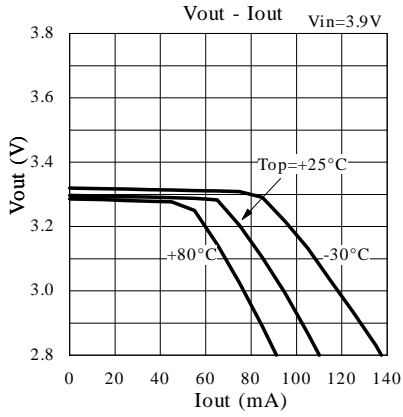

VOLTAGE REGULATOR ELM98xxxA

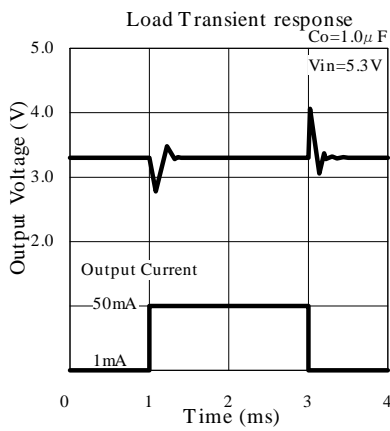
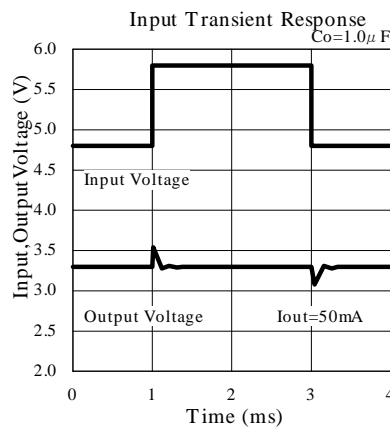
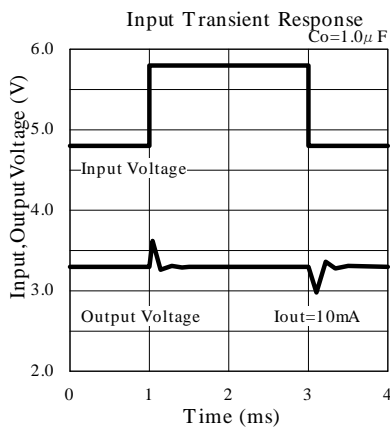
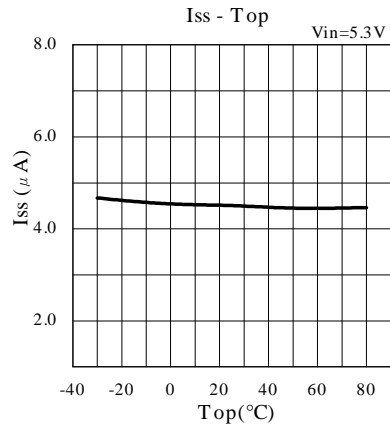
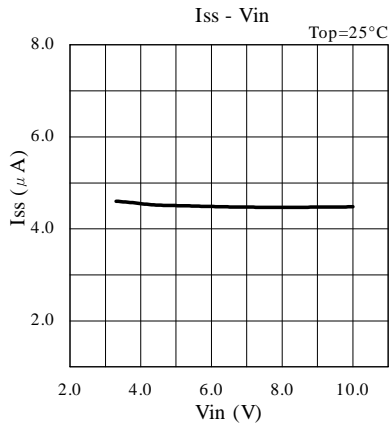

VOLTAGE REGULATOR ELM98xxxA

● ELM9850xA

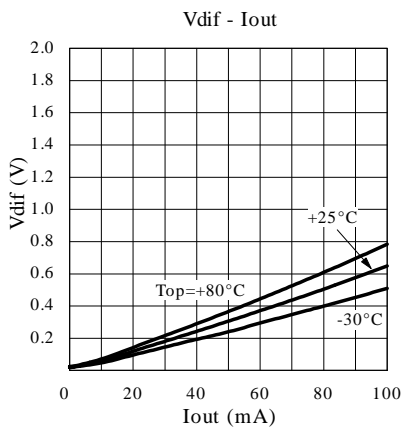
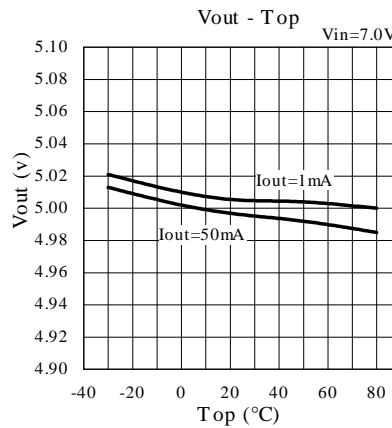
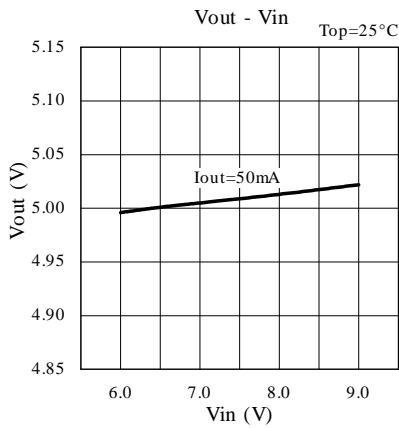
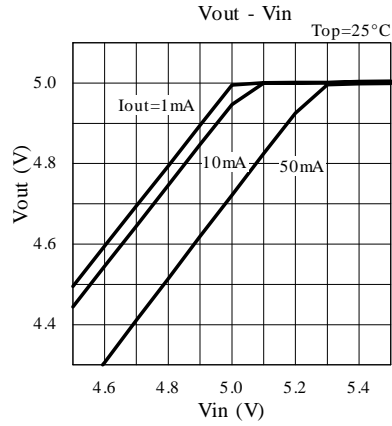
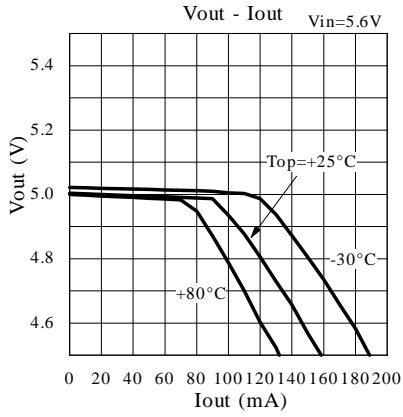

VOLTAGE REGULATOR ELM98xxxA

