

SANYO	No.1780A	2SC3650
		NPN Epitaxial Planar Silicon Transistor High h_{FE} , Low-Frequency General-Purpose Amp Applications

Applications

- . LF amp, various drivers, muting circuit

Features

- . High DC current gain ($h_{FE}=800$ to 3200)
- . Low collector-to-emitter saturation voltage [$V_{CE(sat)} \leq 0.5V$]
- . Large current capacity ($I_C=1.2V$)
- . Very small size making it easy to provide high-density, small-sized hybrid IC's.

Absolute Maximum Ratings at $T_a=25^\circ C$

			unit
Collector to Base Voltage	V_{CBO}	30	V
Collector to Emitter Voltage	V_{CEO}	25	V
Emitter to Base Voltage	V_{EBO}	15	V
Collector Current	I_C	1.2	A
Collector Current(Pulse)	I_{CP}	2	A
Collector Dissipation	P_C	500	mW
	P_C^*	1.5	W
Junction Temperature	T_J	150	$^\circ C$
Storage Temperature	T_{stg}	-55 to +150	$^\circ C$

* Mounted on ceramic board (250mm²x0.8mm)

Electrical Characteristics at $T_a=25^\circ C$

			min	typ	max	unit
Collector Cutoff Current	I_{CBO}	$V_{CB}=20V, I_E=0$			0.1	μA
Emitter Cutoff Current	I_{EBO}	$V_{EB}=10V, I_C=0$			0.1	μA
DC Current Gain	$h_{FE}(1)$	$V_{CE}=5V, I_C=500mA$	800	1500	3200	
	$h_{FE}(2)$	$V_{CE}=5V, I_C=10mA$	600			
Gain-Bandwidth Product	f_T	$V_{CE}=10V, I_C=50mA$		220		MHz
Output Capacitance	c_{ob}	$V_{CB}=10V, f=1MHz$		17		pF
Collector to Emitter Saturation Voltage	$V_{CE(sat)}$	$I_C=500mA, I_B=10mA$	0.12	0.5		V

Continued on next page.

Marking : CF

Package Dimensions 2038

(unit:mm)

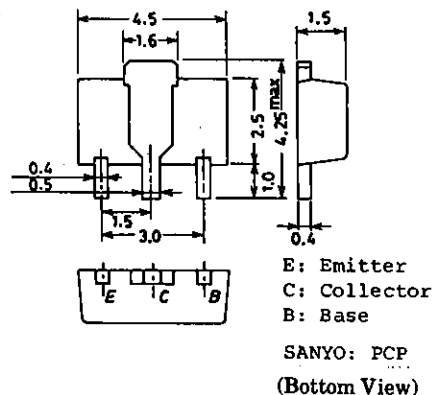

Continued from preceding page.

			min	typ	max	unit
Base to Emitter Saturation Voltage	$V_{BE(sat)}$	$I_C=500mA, I_E=10mA$		0.85	1.2	V
Collector to Base Breakdown Voltage	$V_{(BR)CBO}$	$I_C=10\mu A, I_E=0$	30			V
Collector to Emitter Breakdown Voltage	$V_{(BR)CEO}$	$I_C=1mA, I_B=0$	25			V
Emitter to Base Breakdown Voltage	$V_{(BR)EBO}$	$I_E=10\mu A, I_C=0$	15			V

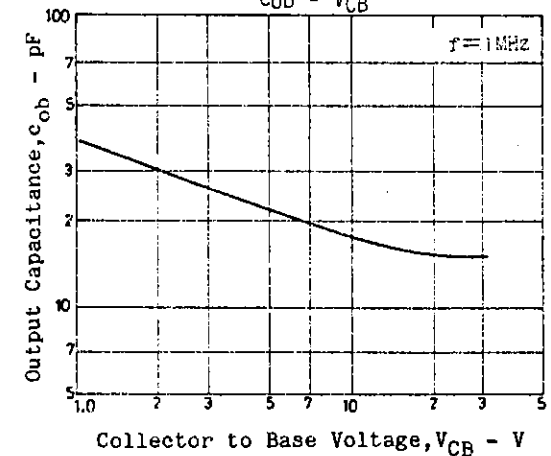
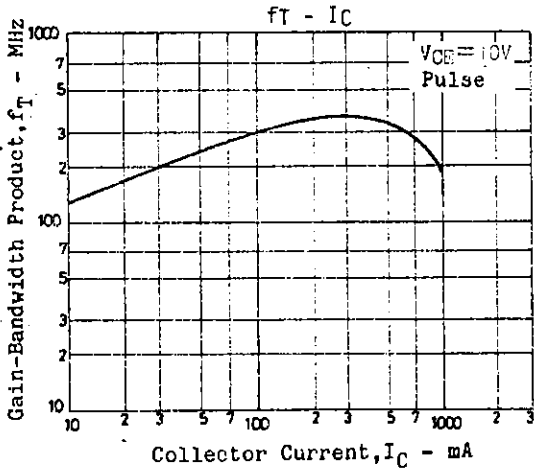
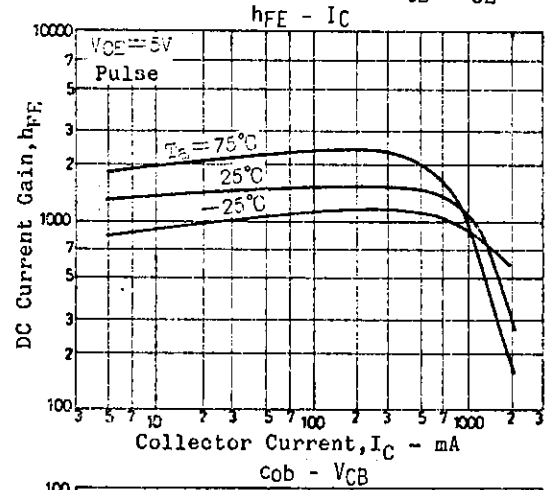
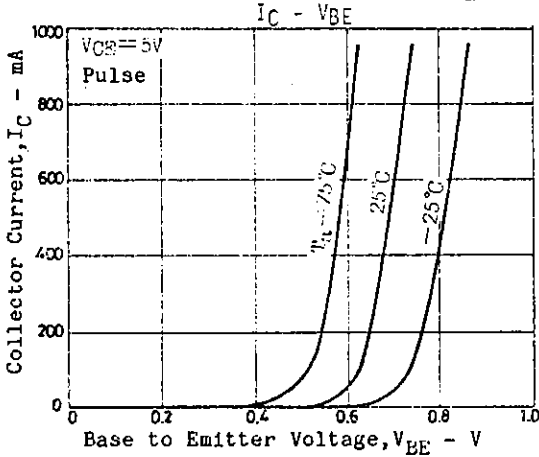
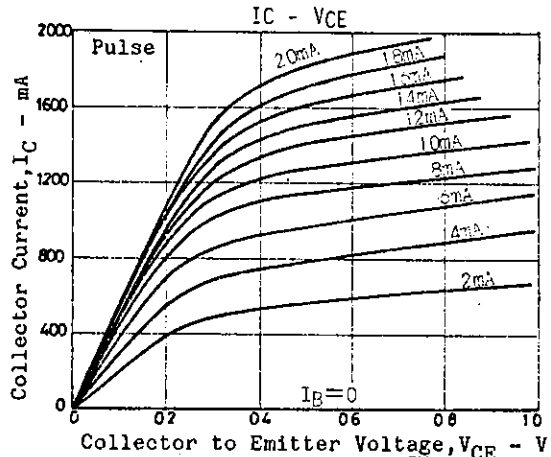
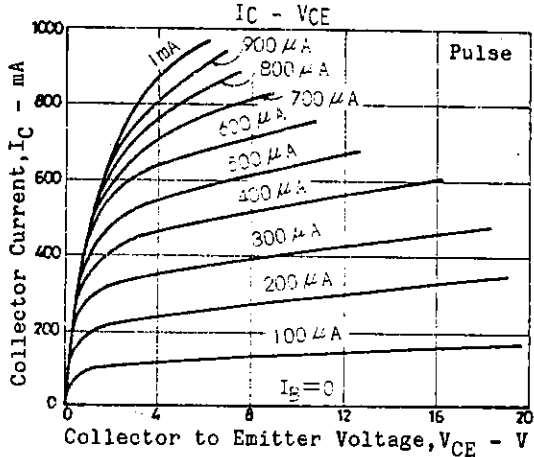

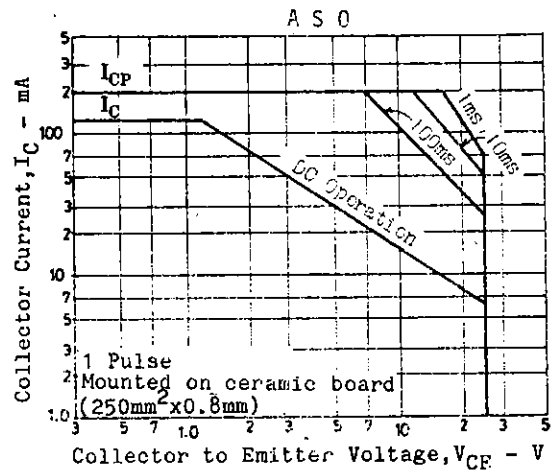
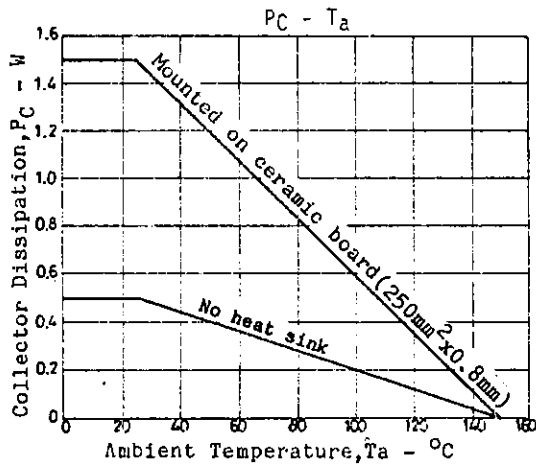
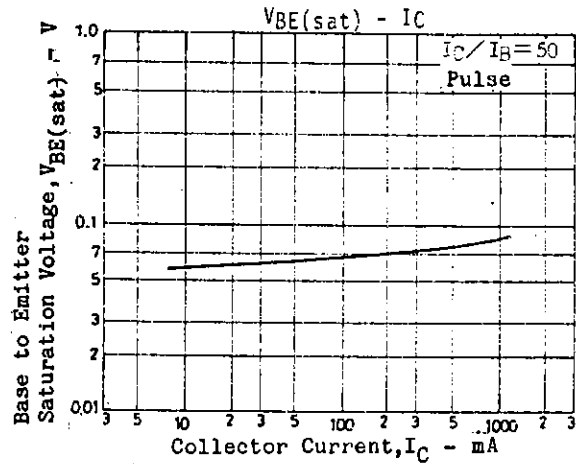
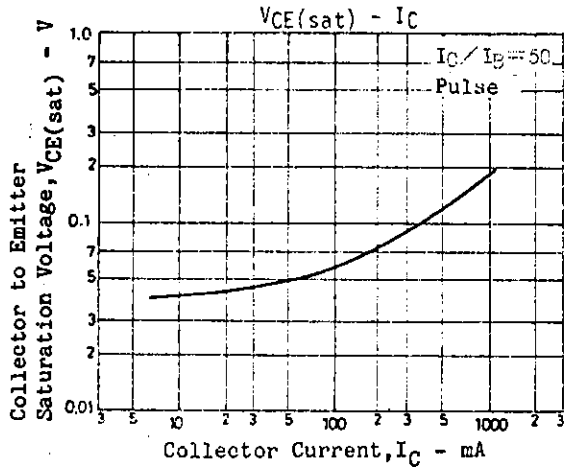

- No products described or contained herein are intended for use in surgical implants, life-support systems, aerospace equipment, nuclear power control systems, vehicles, disaster/crime-prevention equipment and the like, the failure of which may directly or indirectly cause injury, death or property loss.
- Anyone purchasing any products described or contained herein for an above-mentioned use shall:
 - ① Accept full responsibility and indemnify and defend SANYO ELECTRIC CO., LTD., its affiliates, subsidiaries and distributors and all their officers and employees, jointly and severally, against any and all claims and litigation and all damages, cost and expenses associated with such use;
 - ② Not impose any responsibility for any fault or negligence which may be cited in any such claim or litigation on SANYO ELECTRIC CO., LTD., its affiliates, subsidiaries and distributors or any of their officers and employees jointly or severally.
- Information (including circuit diagrams and circuit parameters) herein is for example only; it is not guaranteed for volume production. SANYO believes information herein is accurate and reliable, but no guarantees are made or implied regarding its use or any infringements of intellectual property rights or other rights of third parties.