

2SC5938FOR LOW FREQUENCY AMPLIFY APPLICATION
SILICON NPN EPITAXIAL TYPE

DESCRIPTION

ISAHAYA 2SC5938 is a super mini package resin sealed silicon NPN epitaxial transistor for muting and switching application

FEATURE

- High Emitter to Base voltage $V_{EBO}=50V$
- High Reverse h_{FE}
- Low ON RESISTANCE. $R_{ON}=1$
- Small package for mounting

APPLICATION

For muting, switching application

MAXIMUM RATINGS ($T_a=25$)

Symbol	Parameter	Ratings	Unit
V_{CBO}	Collector to Base voltage	50	V
V_{CEO}	Collector to Emitter voltage	12	V
V_{EBO}	Emitter to Base voltage	50	V
I_C	Collector current	200	mA
P_C	Collector dissipation	150	mW
T_j	Junction temperature	+125	
T_{stg}	Storage temprature	-55 ~ +125	

ELECTRICAL CHARACTERISTICS ($T_a=25$)

Symbol	Parameter	Test conditions	Limits			Unit
			Min	Typ	Max	
I_{CBO}	Collector cut off current	$V_{CB}=50V, I_E=0mA$			0.1	μA
I_{EBO}	Emitter cut off current	$V_{EB}=50V, I_C=0mA$			0.1	μA
h_{FE}	DC forward current gain	$V_{CE}=2V, I_C=4mA$	200		1200	
$V_{CE(sat)}$	C to E saturation voltage	$I_C=30mA, I_B=3mA$		30		mV
f_T	Gain bandwidth product	$V_{CE}=6V, I_C=4mA$		30		MHz
C_{ob}	Collector output capacitance	$V_{CB}=10V, I_E=0mA, f=1MHz$		5.0		pF

Item	A	B
h_{FE}	200 to 700	350 to 1200
Marking	5A	5B

OUTLINE DRAWING

Unit : mm

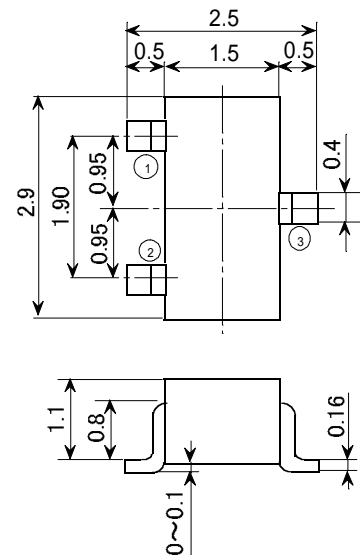

TERMINAL CONNECTOR

- ① : BASE
- ② : EMITTER
- ③ : COLLECTOR

EIJA:SC-59

MARKING

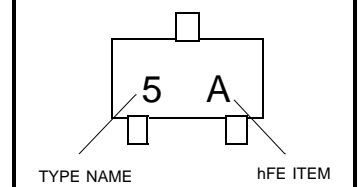

2SC5938

FOR LOW FREQUENCY AMPLIFY APPLICATION
SILICON NPN EPITAXIAL TYPE

COMMON EMITTER OUTPUT

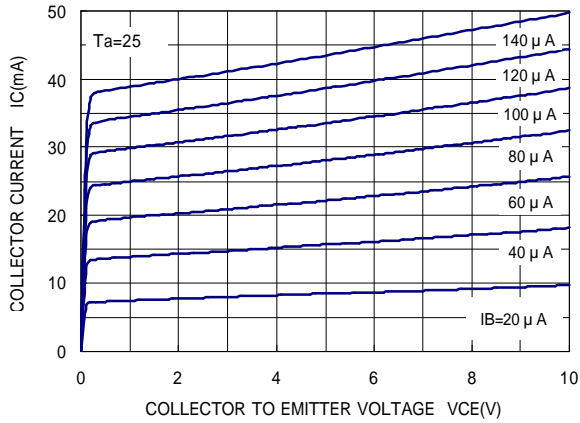

COMMON EMITTER TRANSFER

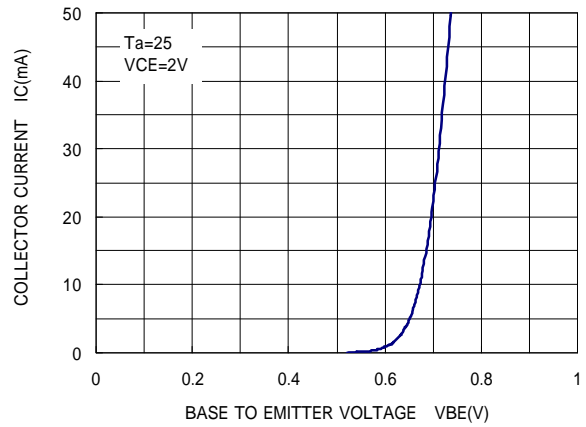

DC FORWARD CURRENT GAIN VS. COLLECTOR CURRENT

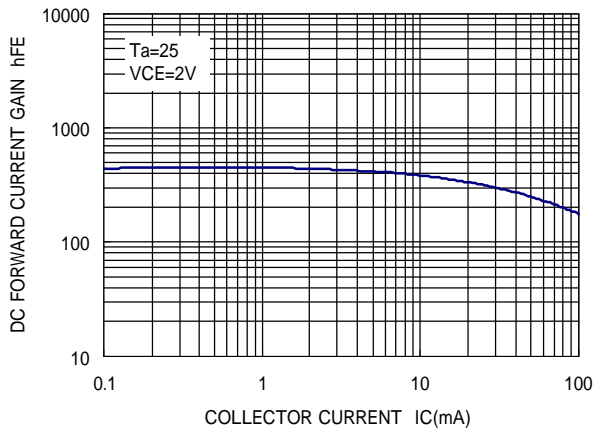

DC REVERSE CURRENT GAIN VS. COLLECTOR CURRENT

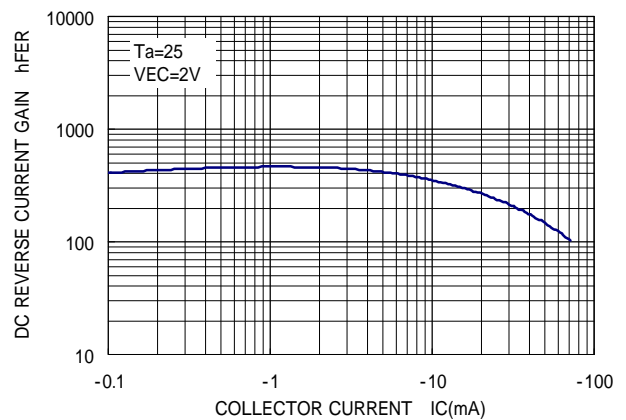

COLLECTOR TO EMITTER SATURATION VOLTAGE VS. COLLECTOR CURRENT

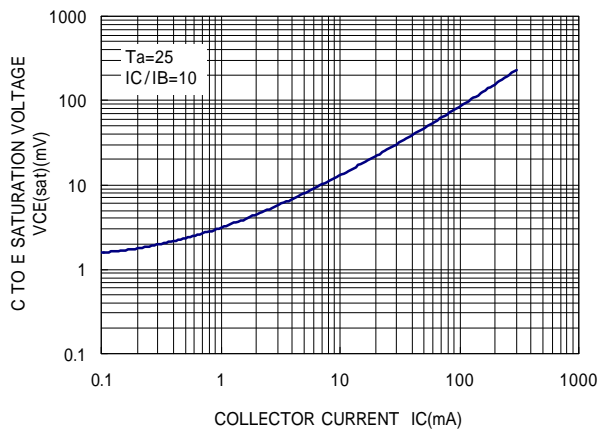

ON RESISTANCE VS. BASE CURRENT

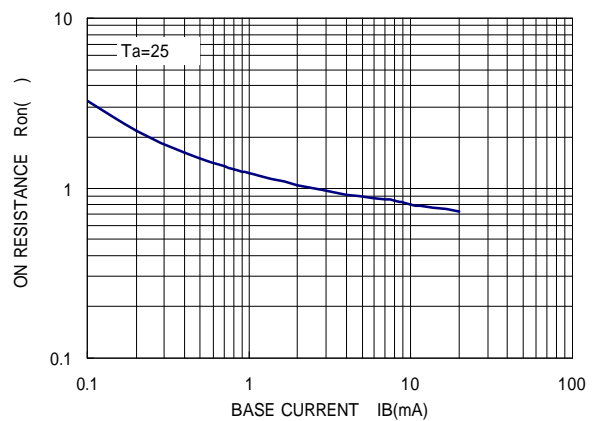

2SC5938

FOR LOW FREQUENCY AMPLIFY APPLICATION
SILICON NPN EPITAXIAL TYPE

GAIN BAND WIDTH PRODUCT VS.
EMITTER CURRENT

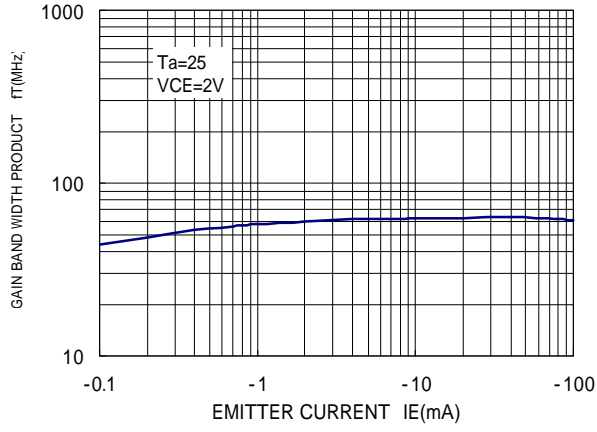

COLLECTOR OUTPUT CAPACITANCE
VS. COLLECTOR TO BASE VOLTAGE

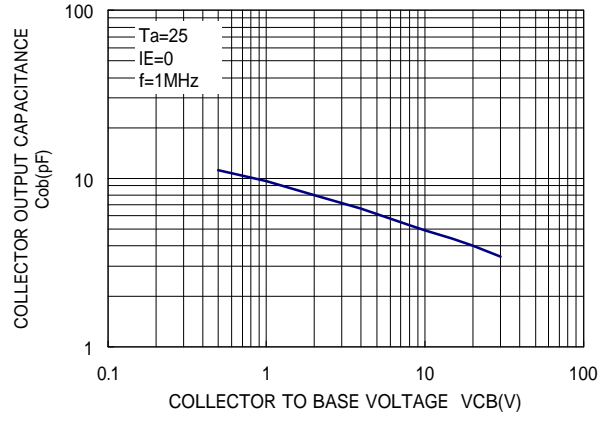



Marketing division, Marketing planning department

6-41 Tsukuba, Isahaya, Nagasaki, 854-0065 Japan

Keep safety first in your circuit designs!

•ISAHAYA Electronics Corporation puts the maximum effort into making semiconductor products better and more reliable, but there is always the possibility that trouble may occur with them. Trouble with semiconductors may lead to personal injury, fire or property damage. Remember to give due consideration to safety when making your circuit designs, with appropriate measures such as (1) placement of substitutive, auxiliary, (2) use of non-flammable material or (3) prevention against any malfunction or mishap.

Notes regarding these materials

- These materials are intended as a reference to our customers in the selection of the ISAHAYA products best suited to the customer's application; they don't convey any license under any intellectual property rights, or any other rights, belonging ISAHAYA or third party.
- ISAHAYA Electronics Corporation assumes no responsibility for any damage, or infringement of any third party's rights, originating in the use of any product data, diagrams, charts or circuit application examples contained in these materials.
- All information contained in these materials, including product data, diagrams and charts, represent information on products at the time of publication of these materials, and are subject to change by ISAHAYA Electronics Corporation without notice due to product improvements or other reasons. It is therefore recommended that customers contact ISAHAYA Electronics Corporation or an authorized ISAHAYA products distributor for the latest product information before purchasing product listed herein.
- ISAHAYA Electronics Corporation products are not designed or manufactured for use in a device or system that is used under circumstances in which human life is potentially at stake. Please contact ISAHAYA electronics corporation or an authorized ISAHAYA products distributor when considering the use of a product contained herein for any specific purposes, such as apparatus or systems for transportation, vehicular, medical, aerospace, nuclear, or undersea repeater use.
- The prior written approval of ISAHAYA Electronics Corporation is necessary to reprint or reproduce in whole or in part these materials.
- If these products or technologies are subject to the Japanese export control restrictions, they must be exported under a license from the Japanese government and cannot be imported into a country other than the approved destination. Any diversion or re-export contrary to the export control laws and regulations of Japan and/or the country of destination is prohibited.
- Please contact ISAHAYA Electronics Corporation or authorized ISAHAYA products distributor for further details on these materials or the products contained therein.