

MOS FIELD EFFECT TRANSISTOR

2SK1581

N-CHANNEL MOS FET

FOR SWITCHING

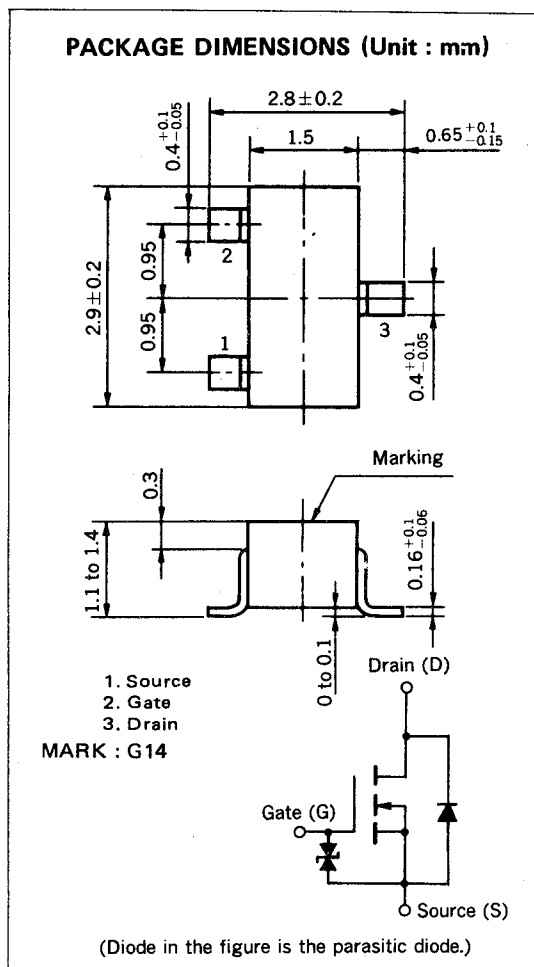

The 2SK1581, N-channel vertical type MOS FET, can be driven by 2.5 V power supply.

As the MOS FET is driven by low voltage and does not require consideration of driving current, it is suitable for appliances including VCR cameras and headphone stereos which need power saving.

FEATURES

- Directly driven by ICs having a 3 V power supply.
- Not necessary to consider driving current because of its high input impedance.
- Possible to reduce the number of parts by omitting the bias resistor.

ABSOLUTE MAXIMUM RATINGS ($T_A = 25^\circ\text{C}$)

PARAMETER	SYMBOL	RATINGS	UNIT	TEST CONDITIONS
Drain to Source Voltage	V_{DSS}	16	V	$V_{GS} = 0$
Gate to Source Voltage	V_{GSS}	±16	V	$V_{DS} = 0$
Drain Current	$I_D(\text{DC})$	±200	mA	
Drain Current	$I_D(\text{pulse})$	±400	mA	$PW \leq 10 \text{ ms}$, Duty Cycle $\leq 50\%$
Total Power Dissipation	P_T	200	mW	
Channel Temperature	T_{ch}	150	$^\circ\text{C}$	
Operating Temperature	T_{opt}	-55 to +80	$^\circ\text{C}$	
Storage Temperature	T_{stg}	-55 to +150	$^\circ\text{C}$	

ELECTRICAL CHARACTERISTICS (T_A = 25 °C)

PARAMETER	SYMBOL	MIN.	TYP.	MAX.	UNIT	TEST CONDITIONS
Drain Cut-off Current	I _{DSS}			1.0	μA	V _{DS} = 16 V, V _{GS} = 0
Gate Leakage Current	I _{GSS}			±5.0	μA	V _{GS} = ±3 V, V _{DS} = 0
Gate Cut-off Voltage	V _{GS(off)}	0.8	1.1	1.6	V	V _{DS} = 3.0 V, I _D = 10 μA
Forward Transfer Admittance	Y _{fs}	20	70		mS	V _{DS} = 3.0 V, I _D = 10 mA
Drain to Source On-State Resistance	R _{DS(on)1}		3.2	5.0	Ω	V _{GS} = 2.5 V, I _D = 1 mA
Drain to Source On-State Resistance	R _{DS(on)2}		2.2	3.0	Ω	V _{GS} = 4.0 V, I _D = 1 mA
Input Capacitance	C _{iss}		27		pF	V _{DS} = 3.0 V, V _{GS} = 0, f = 1 MHz
Output Capacitance	C _{oss}		37		pF	
Feedback Capacitance	C _{rss}		8		pF	
Turn-On Delay Time	t _{d(on)}		100		ns	V _{GS(on)} = 3.0 V, R _G = 10 Ω V _{DD} = 3.0 V, I _D = 10 mA R _L = 300 Ω
Rise Time	t _r		300		ns	
Turn-Off Delay Time	t _{d(off)}		210		ns	
Fall Time	t _f		240		ns	

SWITCHING TIME MEASUREMENT CIRCUIT AND CONDITIONS

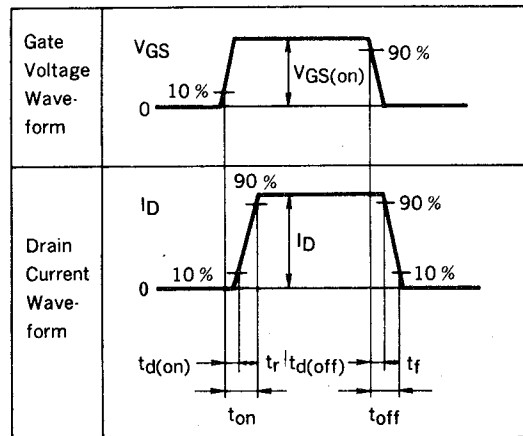
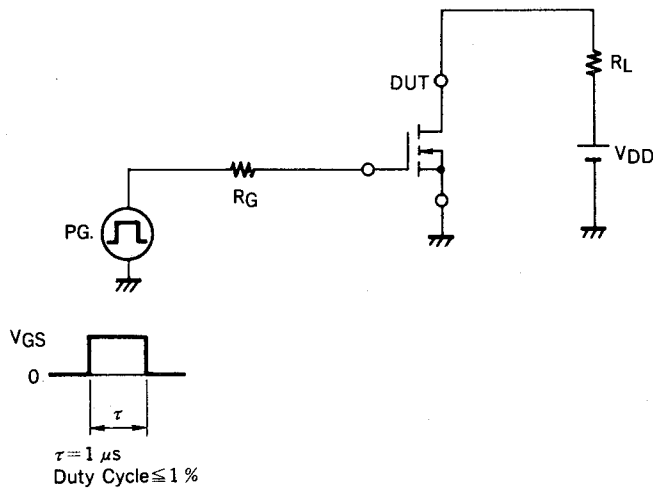

TYPICAL CHARACTERISTICS ($T_A = 25^\circ\text{C}$)

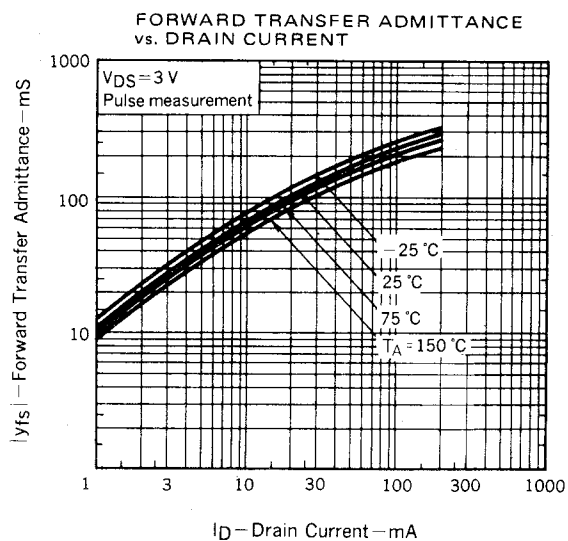
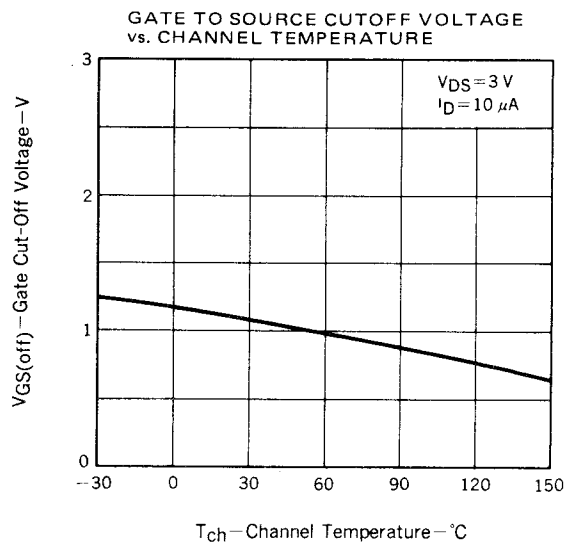
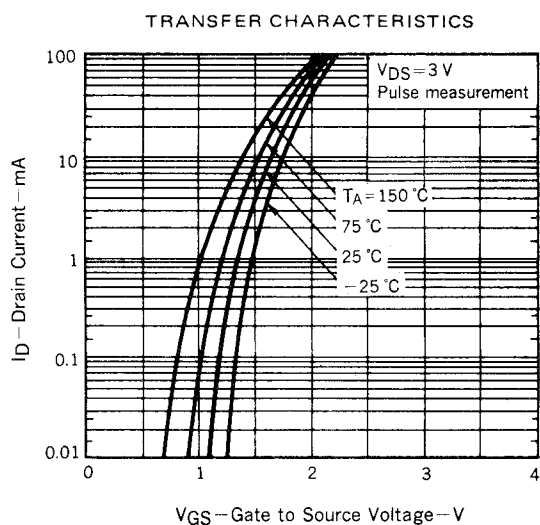
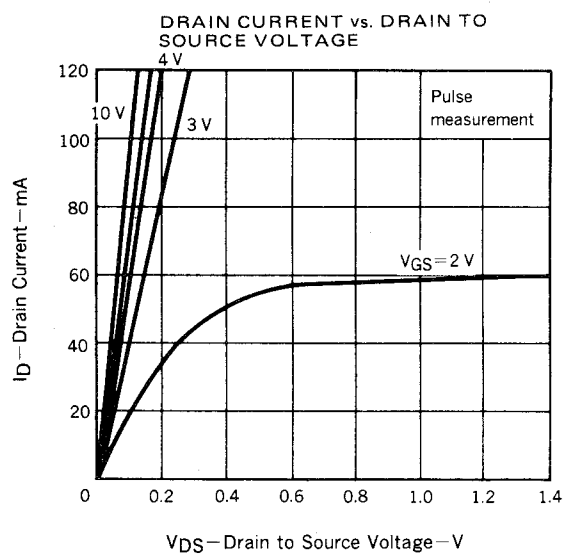
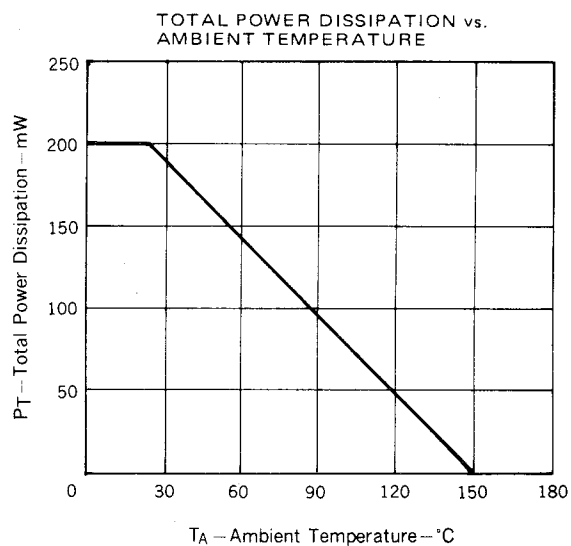
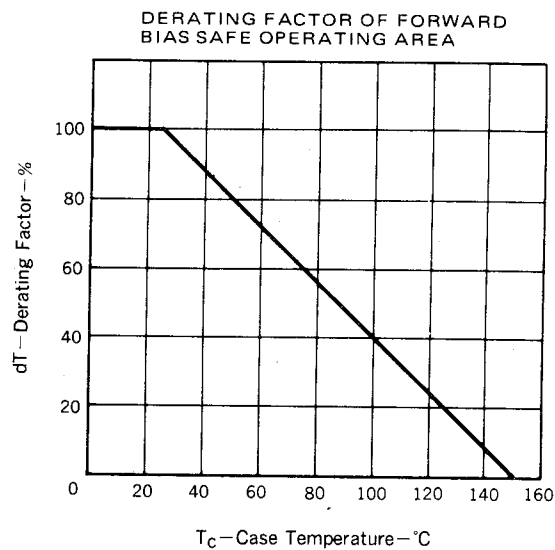

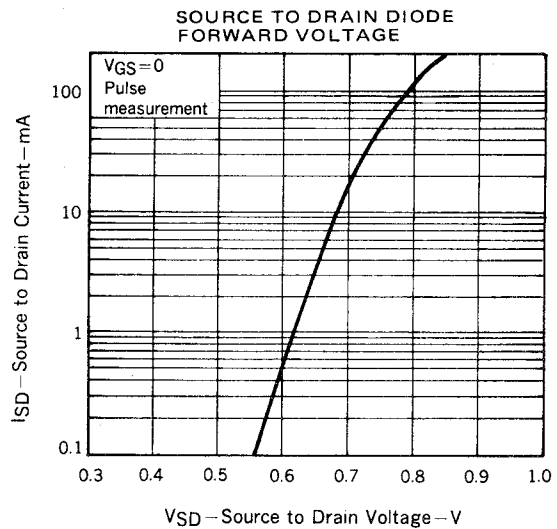
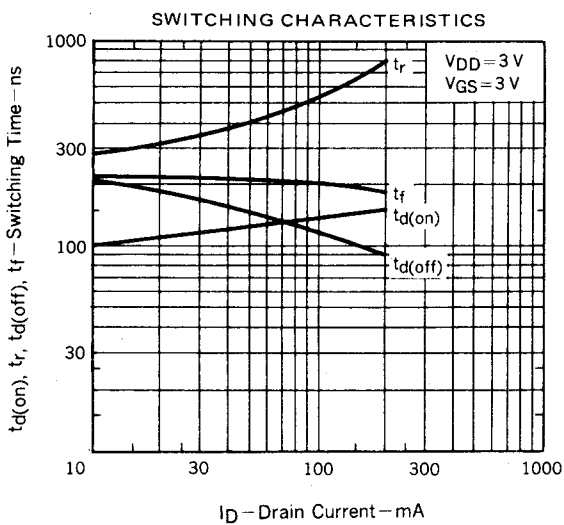
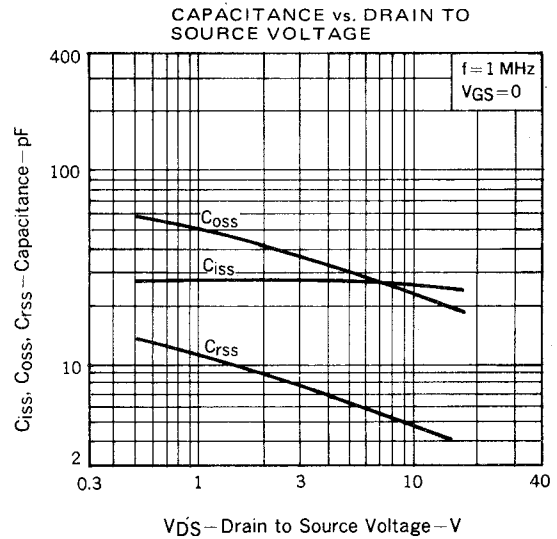
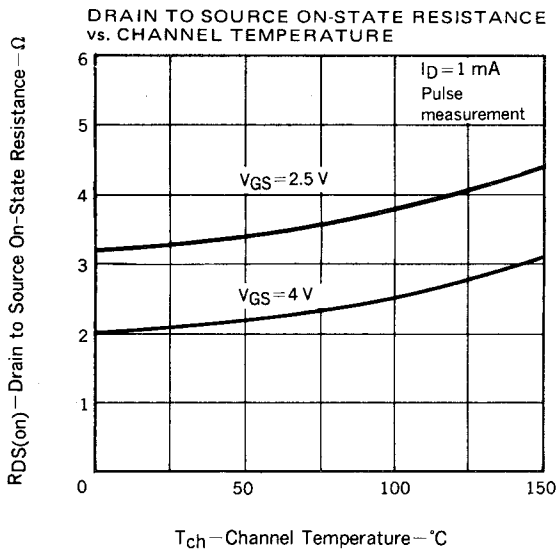
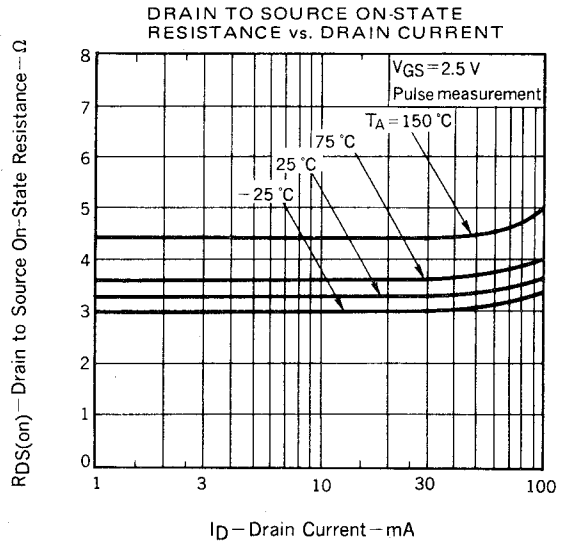
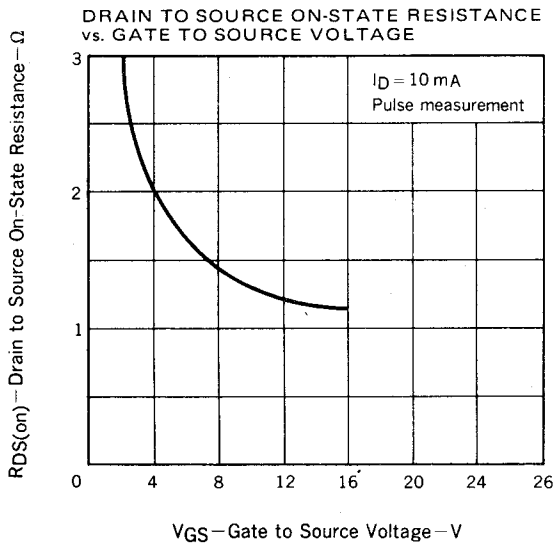

[MEMO]

[MEMO]

[MEMO]

No part of this document may be copied or reproduced in any form or by any means without the prior written consent of NEC Corporation. NEC Corporation assumes no responsibility for any errors which may appear in this document.

NEC Corporation does not assume any liability for infringement of patents, copyrights or other intellectual property rights of third parties by or arising from use of a device described herein or any other liability arising from use of such device. No license, either express, implied or otherwise, is granted under any patents, copyrights or other intellectual property rights of NEC Corporation or others.

While NEC Corporation has been making continuous effort to enhance the reliability of its semiconductor devices, the possibility of defects cannot be eliminated entirely. To minimize risks of damage or injury to persons or property arising from a defect in an NEC semiconductor device, customers must incorporate sufficient safety measures in its design, such as redundancy, fire-containment, and anti-failure features.

NEC devices are classified into the following three quality grades:

"Standard", "Special", and "Specific". The Specific quality grade applies only to devices developed based on a customer designated "quality assurance program" for a specific application. The recommended applications of a device depend on its quality grade, as indicated below. Customers must check the quality grade of each device before using it in a particular application.

Standard: Computers, office equipment, communications equipment, test and measurement equipment, audio and visual equipment, home electronic appliances, machine tools, personal electronic equipment and industrial robots

Special: Transportation equipment (automobiles, trains, ships, etc.), traffic control systems, anti-disaster systems, anti-crime systems, safety equipment and medical equipment (not specifically designed for life support)

Specific: Aircrafts, aerospace equipment, submersible repeaters, nuclear reactor control systems, life support systems or medical equipment for life support, etc.

The quality grade of NEC devices is "Standard" unless otherwise specified in NEC's Data Sheets or Data Books. If customers intend to use NEC devices for applications other than those specified for Standard quality grade, they should contact an NEC sales representative in advance.

Anti-radioactive design is not implemented in this product.