

# MOS FIELD EFFECT TRANSISTOR 2SK1584

## N-CHANNEL MOS FET FOR SWITCHING

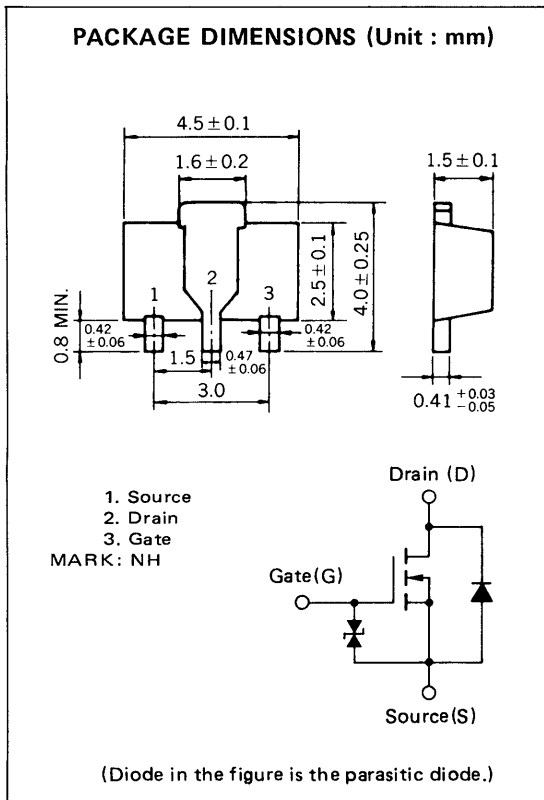

The 2SK1584, N-channel vertical type MOS FET, is a switching device which can be driven directly by the output of ICs having a 5 V power source.

As the MOS FET has low on-state resistance and excellent switching characteristics, it is suitable for driving actuators such as motors, relays, and solenoids.

### FEATURES

- Directly driven by ICs having a 5 V power source.
- Has low on-state resistance.  
 $R_{DS(on)1} = 2.0 \Omega \text{ MAX. @ } V_{GS} = 4.0 \text{ V, } I_D = 0.3 \text{ A}$   
 $R_{DS(on)2} = 1.5 \Omega \text{ MAX. @ } V_{GS} = 10 \text{ V, } I_D = 0.3 \text{ A}$

### QUALITY GRADE

Standard

Please refer to "Quality grade on NEC Semiconductor Devices" (Document number IEI-1209) published by NEC Corporation to know the specification of quality grade on the devices and its recommended applications.

### ABSOLUTE MAXIMUM RATINGS ( $T_a = 25^\circ\text{C}$ )

PARAMETER	SYMBOL	RATINGS	UNIT	TEST CONDITIONS
Drain to Source Voltage	$V_{DSS}$	30	V	$V_{GS} = 0$
Gate to Source Voltage	$V_{GSS}$	$\pm 20$	V	$V_{DS} = 0$
Drain Current	$I_D(\text{DC})$	$\pm 500$	mA	
Drain Current	$I_D(\text{pulse})$	$\pm 1.0$	A	$PW \leq 10 \text{ ms, Duty Cycle} \leq 50 \%$
Total Power Dissipation	$P_T$	2.0	mW	when using ceramic board of $16 \text{ cm}^2 \times 0.7 \text{ mm}$
Channel Temperature	$T_{ch}$	150	$^\circ\text{C}$	
Storage Temperature	$T_{stg}$	$-55 \text{ to } +150$	$^\circ\text{C}$	

ELECTRICAL CHARACTERISTICS (T<sub>a</sub> = 25 °C)

PARAMETER	SYMBOL	MIN.	TYP.	MAX.	UNIT	TEST CONDITIONS
Drain Cut-off Current	I <sub>DSS</sub>			1.0	μA	V <sub>DS</sub> = 30 V, V <sub>GS</sub> = 0
Gate Leakage Current	I <sub>GSS</sub>			±10	μA	V <sub>GS</sub> = ±20 V, V <sub>DS</sub> = 0
Gate Cut-off Voltage	V <sub>GS(off)</sub>	1.3	1.85	2.5	V	V <sub>DS</sub> = 10 V, I <sub>D</sub> = 0.1 mA
Forward Transfer Admittance	Y <sub>fs</sub>	350	440		mS	V <sub>DS</sub> = 5 V, I <sub>D</sub> = 0.5 A
Drain to Source On-State Resistance	R <sub>DS(on)1</sub>		1.2	2.0	Ω	V <sub>GS</sub> = 4.0 V, I <sub>D</sub> = 0.3 A
Drain to Source On-State Resistance	R <sub>DS(on)2</sub>		0.65	1.5	Ω	V <sub>GS</sub> = 10 V, I <sub>D</sub> = 0.3 A
Input Capacitance	C <sub>iss</sub>		60		pF	V <sub>DS</sub> = 10 V, V <sub>GS</sub> = 0, f = 1 MHz
Output Capacitance	C <sub>oss</sub>		50		pF	
Feedback Capacitance	C <sub>rss</sub>		9		pF	
Turn-On Delay Time	t <sub>d(on)</sub>		80		ns	V <sub>GS(on)</sub> = 4 V, R <sub>G</sub> = 10 Ω V <sub>DD</sub> = 10 V, I <sub>D</sub> = 0.3 A R <sub>L</sub> = 33 Ω
Rise Time	t <sub>r</sub>		270		ns	
Turn-Off Delay Time	t <sub>d(off)</sub>		100		ns	
Fall Time	t <sub>f</sub>		110		ns	

SWITCHING TIME MEASUREMENT CIRCUIT AND CONDITIONS

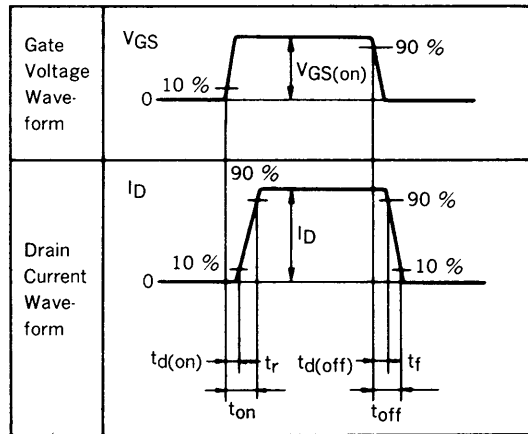
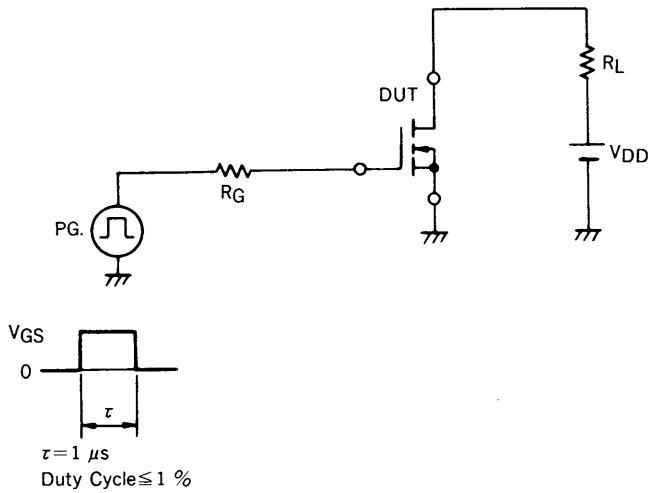

TYPICAL CHARACTERISTICS (T<sub>a</sub> = 25 °C)

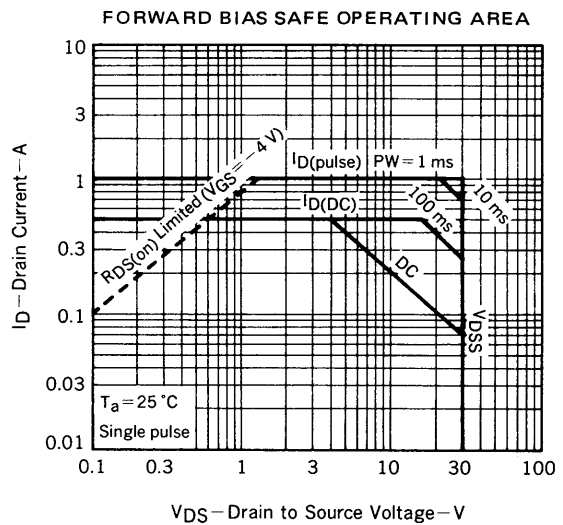
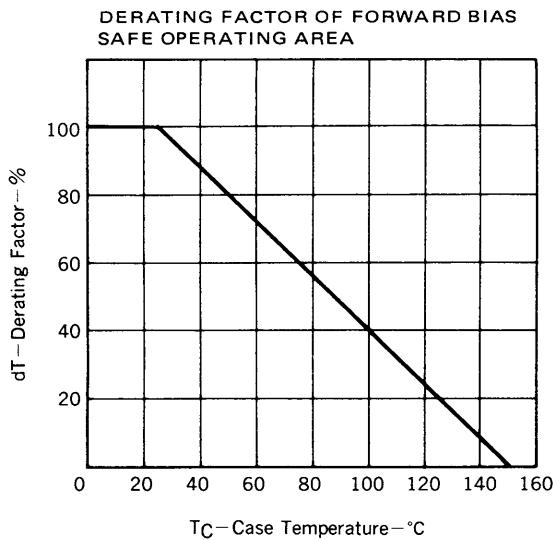

TOTAL POWER DISSIPATION vs. AMBIENT TEMPERATURE

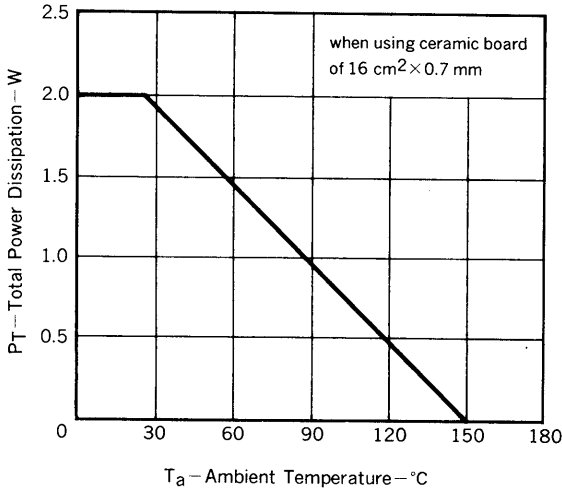

DRAIN CURRENT vs. DRAIN TO SOURCE VOLTAGE

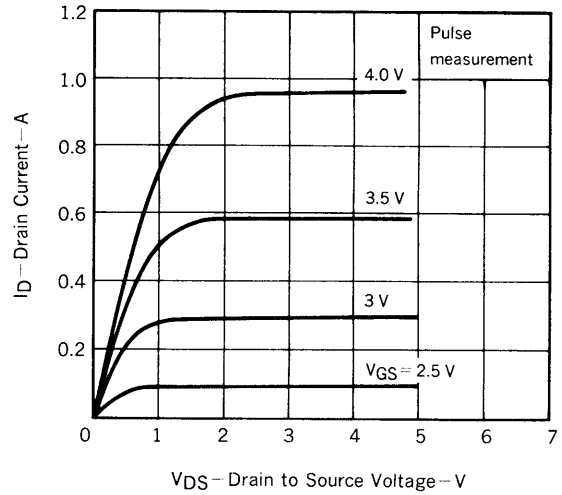

TRANSFER CHARACTERISTICS

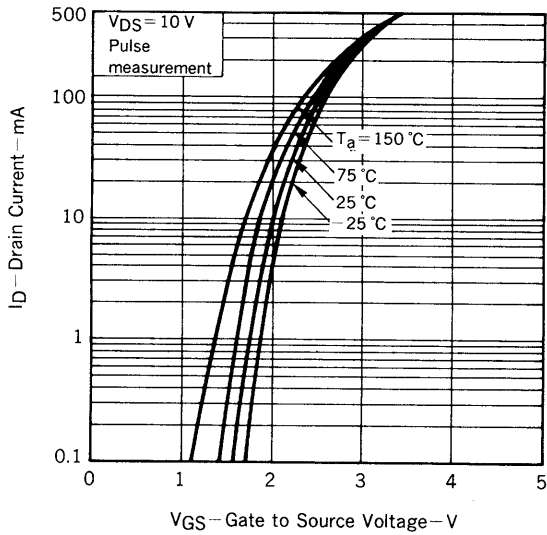

GATE TO SOURCE CUTOFF VOLTAGE vs. CHANNEL TEMPERATURE

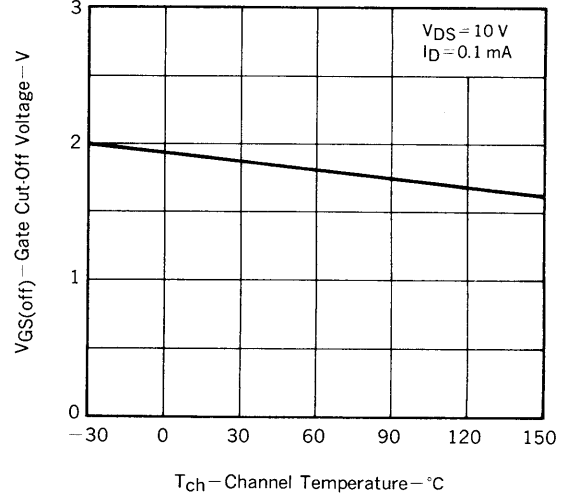

FORWARD TRANSFER ADMITTANCE vs. DRAIN CURRENT

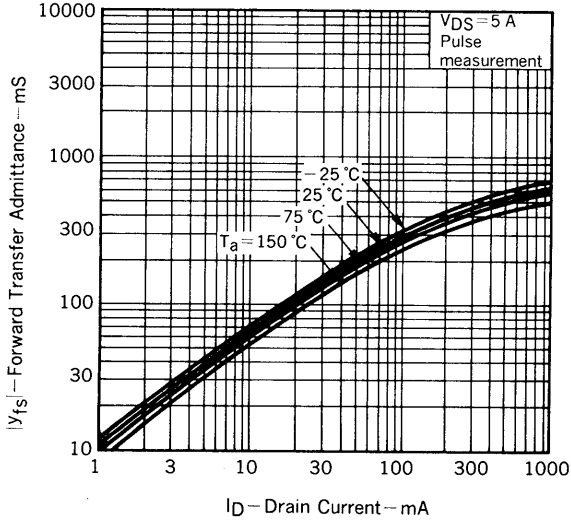

DRAIN TO SOURCE ON-STATE RESISTANCE vs. GATE TO SOURCE VOLTAGE

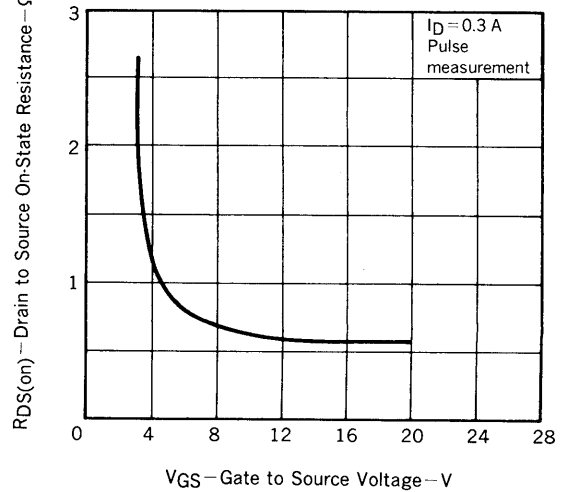

DRAIN TO SOURCE ON-STATE RESISTANCE vs. DRAIN CURRENT

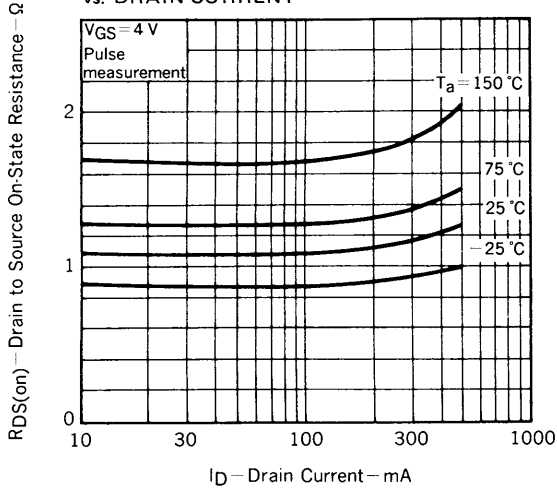

DRAIN TO SOURCE ON-STATE RESISTANCE vs. CHANNEL TEMPERATURE

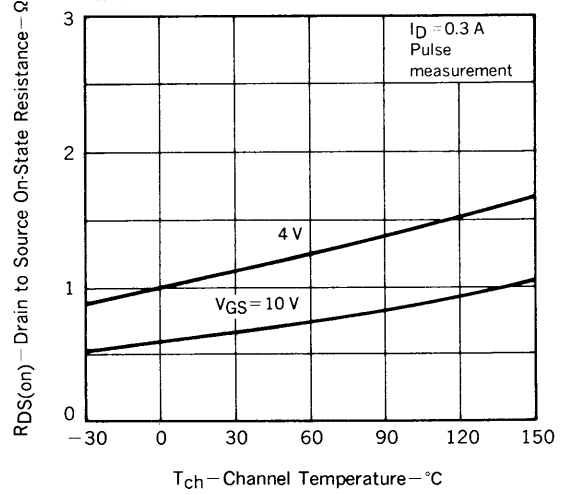

CAPACITANCE vs. DRAIN TO SOURCE VOLTAGE

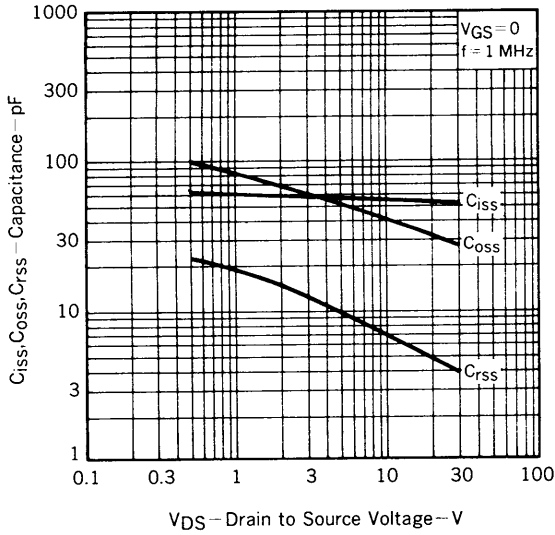

SWITCHING CHARACTERISTICS

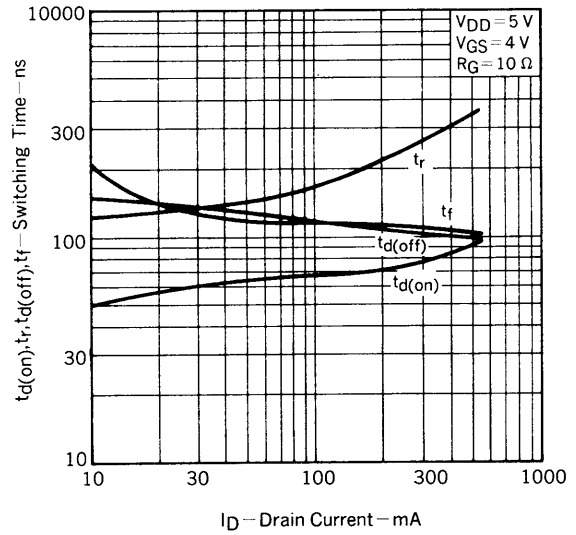

SOURCE TO DRAIN DIODE FORWARD VOLTAGE

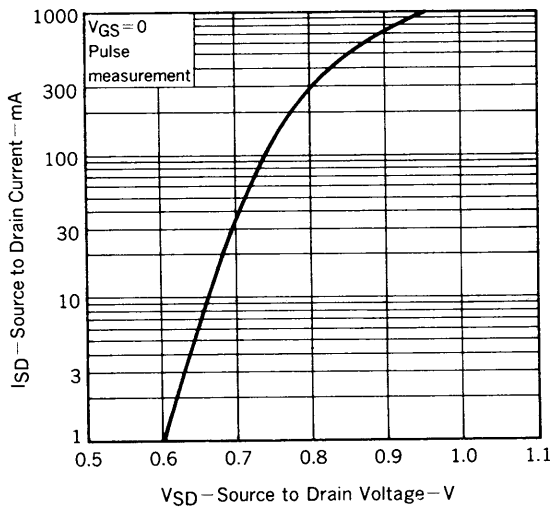

**RECOMMENDED SOLDERING CONDITIONS**

Mounting of this product by soldering should be done under the following conditions.  
Please consult our representatives about soldering methods and conditions other than these.

**SURFACE MOUNT TYPE**

For details of the recommended soldering conditions, see the information document.  
"Device Mounting Manual for Surface Mounting (IEI-1207)."

Soldering Method	Soldering Conditions	Symbol for Recommended Conditions
Infrared Reflow	Package peak temp.: 230 °C Soldering time: within 30 sec (above 210 °C) Soldering times: 1, Days limitation: none*	IR30-00
Vapor Phase Soldering	Package peak temp.: 215 °C Soldering time: within 40 sec (above 200 °C) Soldering times: 1, Days limitation: none*	VP15-00
Wave Soldering	Soldering bath temp.: below 260 °C Soldering time: within 10 sec Soldering times: 1, Days limitation: none*	WS60-00

\*: Stored days under storage conditions at 25 °C and below 65 % R.H. after the dry-pack has been opened.

**Note 1** Combination of soldering methods should be avoided.

**REFERENCE**

Document Name	Document No.
NEC semiconductor device reliability/quality control system.	TEI-1202
Quality grade on NEC semiconductor devices.	IEI-1209
Semiconductor device mounting technology manual.	IEI-1207
Semiconductor device package manual.	IEI-1213
Guide to quality assurance for semiconductor devices.	MEI-1202
Semiconductor selection guide.	MF-1134

[MEMO]

No part of this document may be copied or reproduced in any form or by any means without the prior written consent of NEC Corporation. NEC Corporation assumes no responsibility for any errors which may appear in this document.

NEC Corporation does not assume any liability for infringement of patents, copyrights or other intellectual property rights of third parties by or arising from use of a device described herein or any other liability arising from use of such device. No license, either express, implied or otherwise, is granted under any patents, copyrights or other intellectual property rights of NEC Corporation or others.

The devices listed in this document are not suitable for use in aerospace equipment, submarine cables, nuclear reactor control systems and life support systems. If customers intend to use NEC devices for above applications or they intend to use "Standard" quality grade NEC devices for applications not intended by NEC, please contact our sales people in advance.

Application examples recommended by NEC Corporation

Standard: Computer, Office equipment, Communication equipment, Test and Measurement equipment, Machine tools, Industrial robots, Audio and Visual equipment, Other consumer products, etc.

Special: Automotive and Transportation equipment, Traffic control systems, Antidisaster systems, Anticrime systems, etc.