

# 1 A Slew Rate Controlled Load Switch in PPAK SC75-6

## DESCRIPTION

The SiP4282 is a P-Channel MOSFET power switch IC designed for high-side load switching applications. The output switching transistor is a P-Channel MOSFET device that has a 140 mΩ  $R_{DS(ON)}$  typically to increase load switching power handling capacity. The SiP4282 is available in two different versions with turn-on and turn-off characteristics ranging from very fast to slew rate limited. In addition to a fast turn-off time of 4 μs, the SiP4282-3 version offers a shutdown load discharge circuit to instantaneously turn off a load circuit when the switch is disabled.

The SiP4282 load switch operates with an input voltage ranging from 1.8 V to 5.5 V, making it ideal for both 3 V and 5 V systems. The SiP4282 also features an under-voltage lock out which turns the switch off when an input undervoltage condition exists. Input logic levels are TTL and 2.5 V to 5 V CMOS compatible. This device has a very low operating current (typically 2.5 μA), making it ideal for battery-powered applications. In shutdown mode, the supply current decreases to less than 1 μA.

The SiP4282 is available in a lead (Pb)-free 6 pin PPAK SC75-6 package and is specified over - 40 °C to 85 °C temperature range.

## FEATURES

- 1.8 V to 5.5 V Input Voltage range
- Very Low  $R_{DS(ON)}$ , typically 140 mΩ at 5 V and 175 mΩ at 3 V
- Slew rate limited turn-on time options
  - SiP4282-1: 1 ms
  - SiP4282-3: 100 μs
- Fast shutdown load discharge option
- Low quiescent current, typically 2.5 μA
- Low Shutdown Current < 1 μA
- TTL/CMOS input logic level
- UVLO of 1.4 V
- SC-75 Package



## APPLICATIONS

- Cellular telephones
- Digital still cameras
- Personal digital assistants (PDA)
- Hot swap supplies
- Notebook computers
- Personal communication devices
- USB

## TYPICAL APPLICATION CIRCUIT

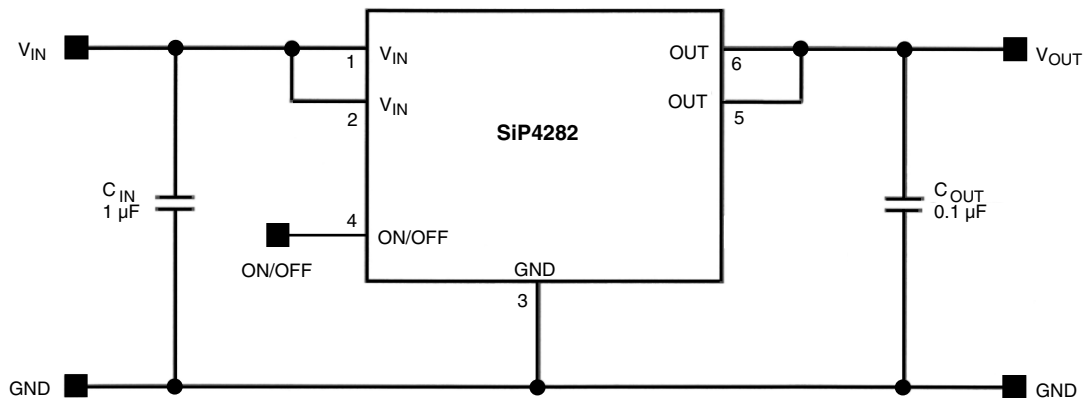

SiP4282 Typical Application Circuit



ABSOLUTE MAXIMUM RATINGS			
Parameter		Limit	Unit
Supply Input Voltage ( $V_{IN}$ )		- 0.3 to 6	V
Enable Input Voltage ( $V_{ON}$ )		- 0.3 to 6	
Output Voltage ( $V_{OUT}$ )		- 0.3 to $V_{IN} + 0.3$	
Maximum Continuous Switch Current ( $I_{MAX}$ )		1.2	A
Maximum Pulsed Current ( $I_{DM}$ ) $V_{IN}$	$V_{IN} \geq 2.5$ V	3	
	$V_{IN} < 2.5$ V	1.6	
ESD Rating (HBM)		4000	V
Junction Temperature ( $T_J$ )		- 40 to 150	°C
Thermal Resistance ( $\theta_{JA}$ ) <sup>a</sup>	6 pin PPAK SC75	90	°C/W
Power Dissipation ( $P_D$ ) <sup>b</sup>	6 pin PPAK SC75	610	mW

Notes:

- a. Device mounted with all leads and power pad soldered or welded to PC board.  
 b. Derate 11.1 mW/°C above  $T_A = 70$  °C.

Stresses beyond those listed under "Absolute Maximum Ratings" may cause permanent damage to the device. These are stress ratings only, and functional operation of the device at these or any other conditions beyond those indicated in the operational sections of the specifications is not implied. Exposure to absolute maximum rating/conditions for extended periods may affect device reliability.

RECOMMENDED OPERATING RANGE			
Parameter		Limit	Unit
Input Voltage Range ( $V_{IN}$ )		1.8 to 5.5	V
Operating Temperature Range		- 40 to 85	°C

SPECIFICATIONS						
Parameter	Symbol	Test Conditions Unless Specified $V_{IN} = 5.0$ , $T_A = -40$ °C to 85 °C (Typical values are at $T_A = 25$ °C)	Limits - 40 °C to 85 °C			Unit
			Min <sup>a</sup>	Typ <sup>b</sup>	Max <sup>a</sup>	
<b>SiP4282 All Versions</b>						
Operating Voltage <sup>c</sup>	$V_{IN}$		1.8	-	5.5	V
Under Voltage Lockout	$V_{UVLO}$	$V_{IN}$ Falling	1.0	1.4	1.8	
Under Voltage Lockout Hysteresis	$V_{UVLO(hyh)}$		-	250	-	mV
Quiescent Current	$I_Q$	ON/OFF = active	-	2.5	4	$\mu$ A
Off Supply Current	$I_{Q(OFF)}$	ON/OFF = inactive, OUT = open	-	-	1	
Off Switch Current	$I_{SD(OFF)}$	ON/OFF = inactive, $V_{OUT} = 0$	-	-	1	
On-Resistance	$R_{DS(on)}$	$V_{IN} = 5$ V, $T_A = 25$ °C	-	140	230	m $\Omega$
		$V_{IN} = 4.2$ V, $T_A = 25$ °C	-	150	250	
		$V_{IN} = 3$ V, $T_A = 25$ °C	-	175	290	
		$V_{IN} = 1.8$ V, $T_A = 25$ °C	-	300	480	
On-Resistance Temp-Coefficient	$TC_{RDS}$		-	2800	-	ppm/°C
ON/OFF Input Low Voltage	$V_{IL}$	$V_{IN} = 2.7$ V to 5.5 V <sup>d</sup>	-	-	0.8	V
ON/OFF Input High Voltage	$V_{IH}$	$V_{IN} = 2.7$ V to $\leq 4.2$ V	2	-	-	
		$V_{IN} > 4.2$ V to 5.5 V	2.4	-	-	
ON/OFF Input Leakage	$I_{SINK}$	$V_{ON/OFF} = 5.5$ V	-	-	1	$\mu$ A
<b>SiP4282-1 Version</b>						
Output Turn-On Delay Time	$T_{D(ON)}$	$V_{IN} = 5$ V, $R_{LOAD} = 10$ $\Omega$ , $T_A = 25$ °C	-	20	40	$\mu$ s
Output Turn-On Rise Time	$T_{I(ON)}$	$V_{IN} = 5$ V, $R_{LOAD} = 10$ $\Omega$ , $T_A = 25$ °C	-	1000	1500	
Output Turn-Off Delay Time	$T_{D(OFF)}$	$V_{IN} = 5$ V, $R_{LOAD} = 10$ $\Omega$ , $T_A = 25$ °C	-	4	10	



SPECIFICATIONS						
Parameter	Symbol	Test Conditions Unless Specified $V_{IN} = 5.0$ , $T_A = -40\text{ }^\circ\text{C}$ to $85\text{ }^\circ\text{C}$ (Typical values are at $T_A = 25\text{ }^\circ\text{C}$ )	Limits - $40\text{ }^\circ\text{C}$ to $85\text{ }^\circ\text{C}$			Unit
			Min <sup>a</sup>	Typ <sup>b</sup>	Max <sup>a</sup>	
<b>SiP4282-3 Version</b>						
Output Turn-On Delay Time	$T_{D(ON)}$	$V_{IN} = 5\text{ V}$ , $R_{LOAD} = 10\ \Omega$ , $T_A = 25\text{ }^\circ\text{C}$	-	20	40	$\mu\text{s}$
Output Turn-On Rise Time	$T_{(ON)}$	$V_{IN} = 5\text{ V}$ , $R_{LOAD} = 10\ \Omega$ , $T_A = 25\text{ }^\circ\text{C}$	-	100	150	
Output Turn-Off Delay Time	$T_{D(OFF)}$	$V_{IN} = 5\text{ V}$ , $R_{LOAD} = 10\ \Omega$ , $T_A = 25\text{ }^\circ\text{C}$	-	4	10	
Output Pull-Down Resistance	$R_{PD}$	ON/OFF = Inactive, $T_A = 25\text{ }^\circ\text{C}$	-	150	250	$\Omega$

Notes:

- a) The algebraic convention whereby the most negative value is a minimum and the most positive a maximum.
- b) Typical values are for DESIGN AID ONLY, not guaranteed nor subject to production testing
- c) Part requires minimum start-up of  $V_{IN} \geq 2.0\text{ V}$  to ensure operation down to  $1.8\text{ V}$ .
- d) For  $V_{IN}$  outside this range consult typical ON/OFF threshold curve.

**PIN CONFIGURATION**

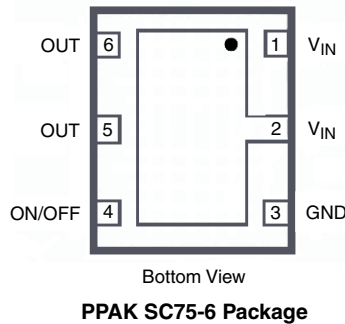

PIN DESCRIPTION		
Pin Number PPAK SC75-6	Name	Function
1, 2	$V_{IN}$	This pin is the P-Channel MOSFET source connection. Bypass to ground through a $1\ \mu\text{F}$ capacitor.
3	GND	Ground Connection
4	ON/OFF	Enable Input
5, 6	OUT	This pin is the P-Channel MOSFET drain connection. Bypass to ground through a $0.1\ \mu\text{F}$ capacitor.

SELECTION GUIDE			
Part Number	Slew Rate (typ)	Active Pull Down	Enable
SiP4282-1-T1-E3	1 ms	No	Active high
SiP4282-3-T1-E3	100 $\mu\text{s}$	Yes	Active high

ORDERING INFORMATION			
Part Number	Marking	Temperature Range	Package
SiP4282DVP-1-T1-E3	L7XXX	- $40\text{ }^\circ\text{C}$ to $85\text{ }^\circ\text{C}$	PPAK SC75-6
SiP4282DVP-3-T1-E3	L9XXX		PPAK SC75-6

Notes:  
XXX = Lot Code



**TYPICAL CHARACTERISTICS** internally regulated, 25 °C, unless otherwise noted

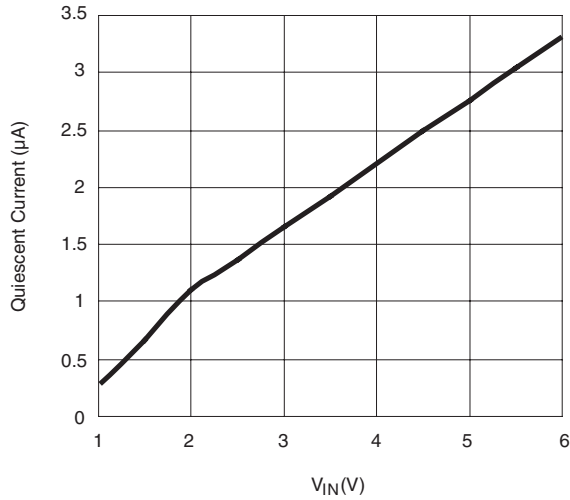

**Quiescent Current vs. Input Voltage**

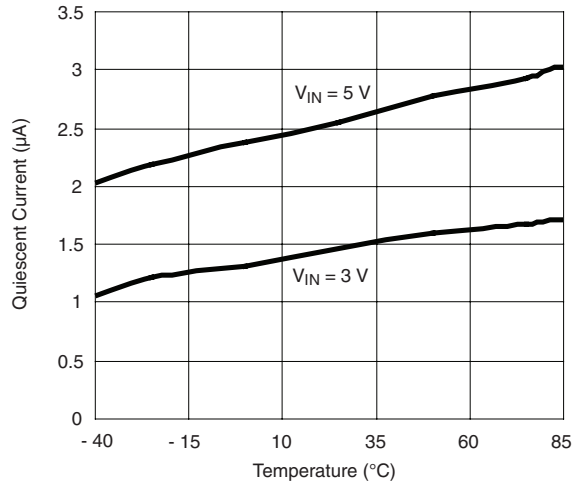

**Quiescent Current vs. Temperature**

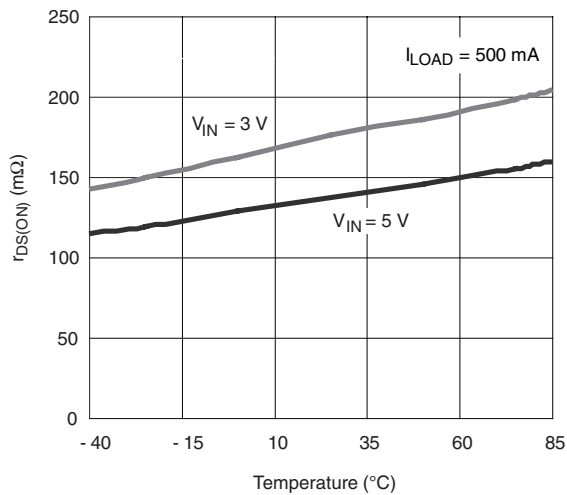

**R<sub>DS(ON)</sub> vs. Temperature**

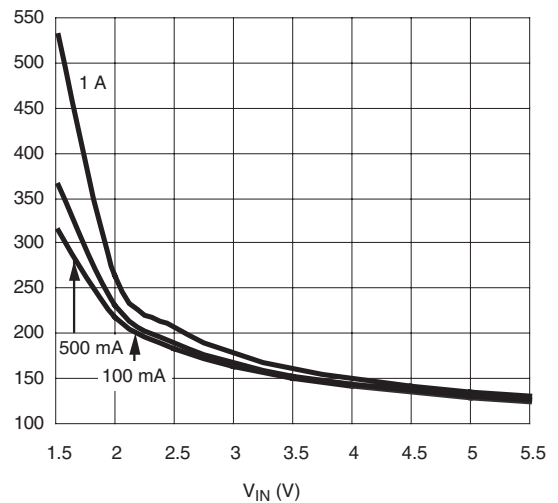

**R<sub>DS(ON)</sub> vs. Input Voltage**

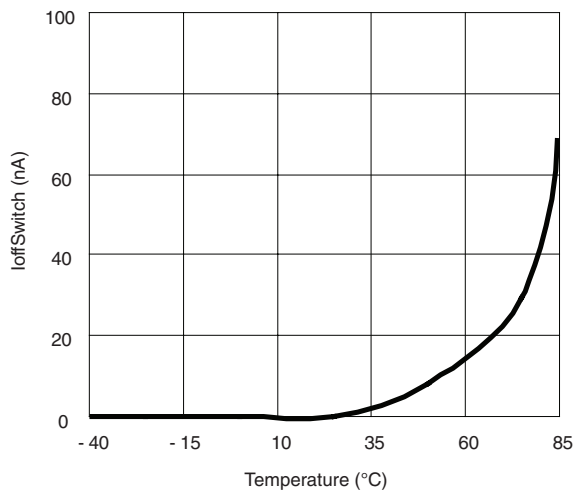

**Off Switch Current vs. Temperature**

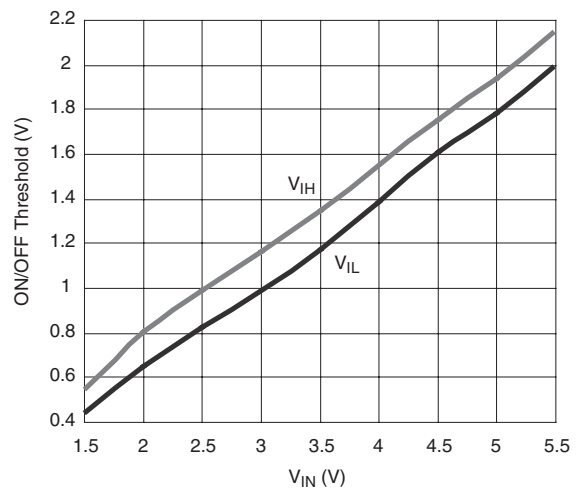

**ON/OFF Threshold vs. Input Voltage**

**TYPICAL WAVEFORMS**

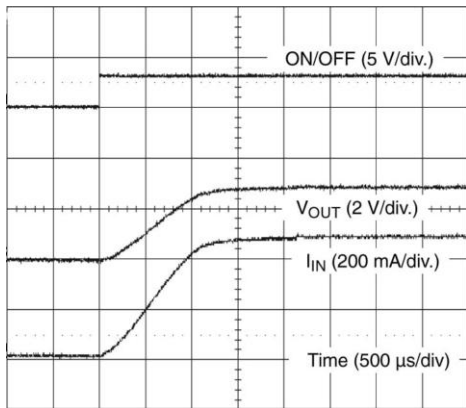

SiP4282-1 Turn-On ( $V_{IN} = 3\text{ V}$ ,  $R_{LOAD} = 6\ \Omega$ )

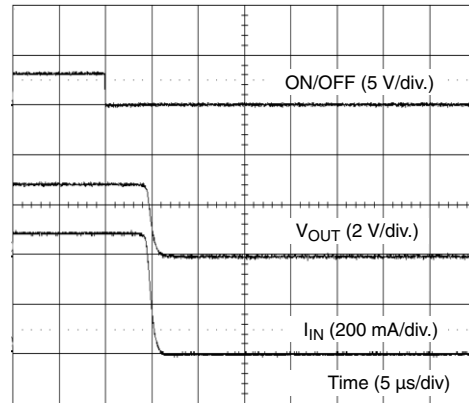

SiP4282-1 Turn-Off ( $V_{IN} = 3\text{ V}$ ,  $R_{LOAD} = 6\ \Omega$ )

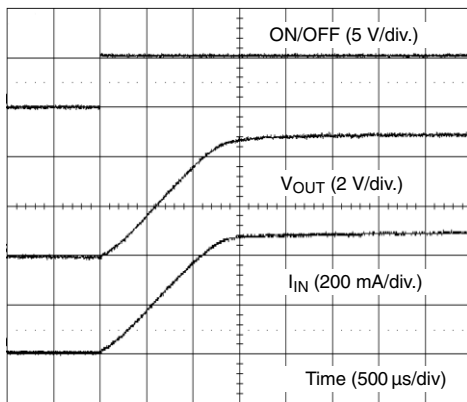

SiP4282-1 Turn-On ( $V_{IN} = 5\text{ V}$ ,  $R_{LOAD} = 10\ \Omega$ )

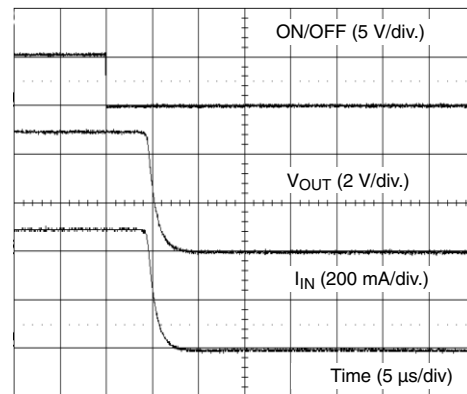

SiP4282-1 Turn-Off ( $V_{IN} = 5\text{ V}$ ,  $R_{LOAD} = 10\ \Omega$ )

# SiP4282

Vishay Siliconix



## TYPICAL WAVEFORMS

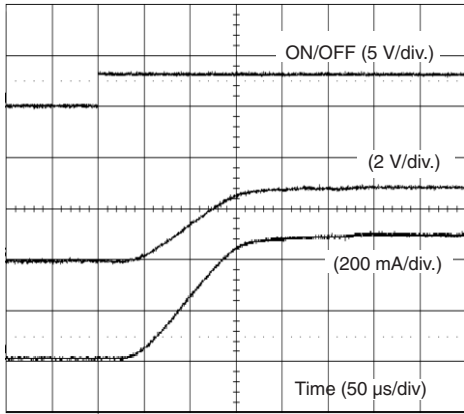

SiP4282-3 Turn-On ( $V_{IN} = 3\text{ V}$ ,  $R_{LOAD} = 6\ \Omega$ )

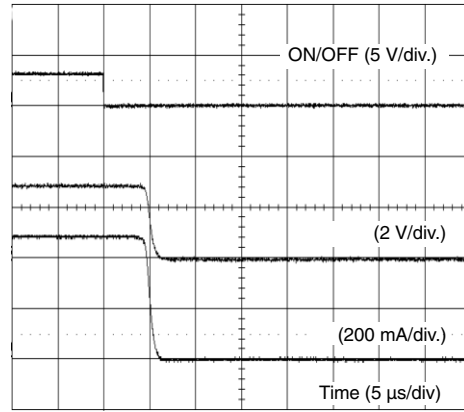

SiP4282-3 Turn-Off ( $V_{IN} = 3\text{ V}$ ,  $R_{LOAD} = 6\ \Omega$ )

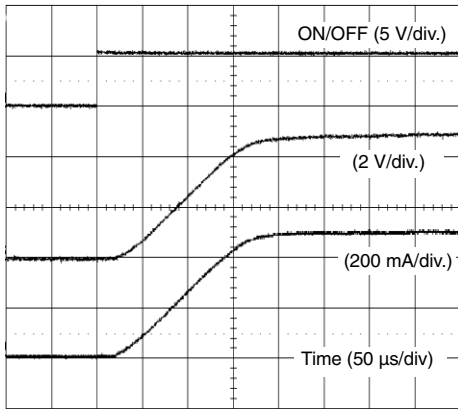

SiP4282-3 Turn-On ( $V_{IN} = 5\text{ V}$ ,  $R_{LOAD} = 10\ \Omega$ )

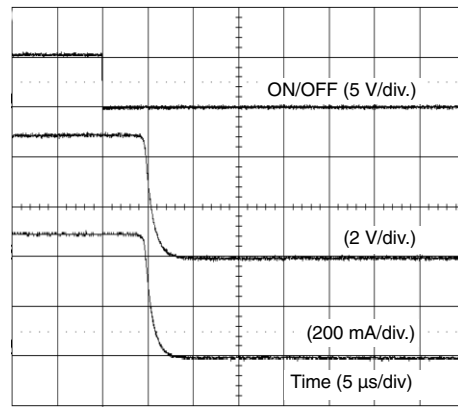

SiP4282-3 Turn-Off ( $V_{IN} = 5\text{ V}$ ,  $R_{LOAD} = 10\ \Omega$ )

**BLOCK DIAGRAM**

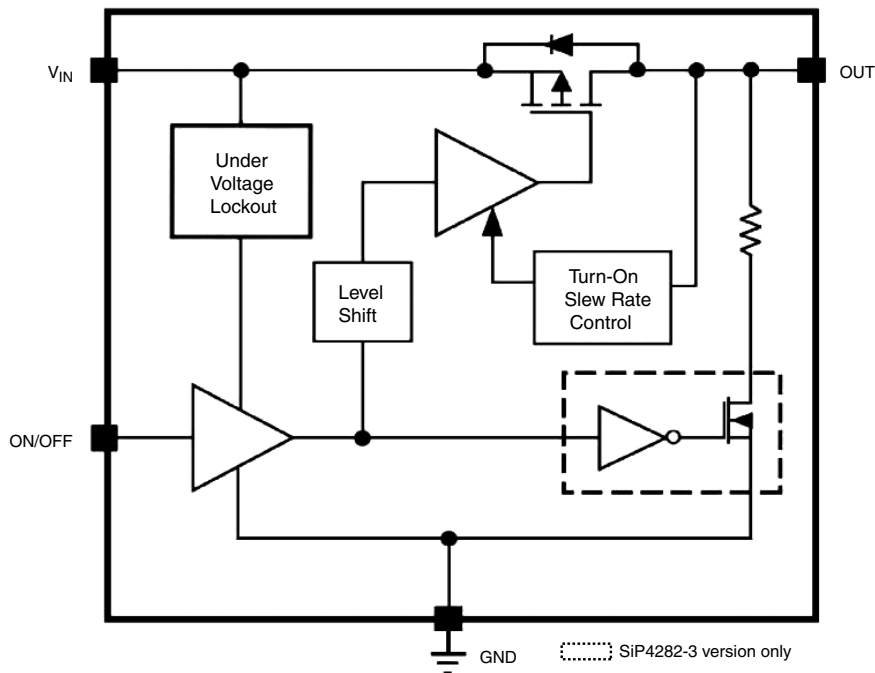

SiP4282 Functional Block Diagram

**DETAILED DESCRIPTION**

The SiP4282 is a P-Channel MOSFET power switches designed for high-side slew rate controlled load-switching applications. Once turned on, the slew-rate control circuitry is activated and current is ramped in a linear fashion until it reaches the level required for the output load condition. This is accomplished by first elevating the gate voltage of the MOSFET up to its threshold voltage and then by linearly increasing the gate voltage until the MOSFET becomes fully enhanced. At this point, the gate voltage is then quickly increased to the full input voltage to reduce  $R_{DS(ON)}$  of the MOSFET switch and minimize any associated power losses.

The SiP4282-1 version has a modest 1 ms turn on slew rate feature, which significantly reduces in-rush current at turned on time and permits the load switch to be implemented with a small input capacitor, or no input capacitor at all, saving cost and space. In addition to a 100  $\mu$ s minimized slew rate, the SiP4282-3 features a shutdown output discharge circuit which is activated at shutdown (when the part is disabled through the ON/OFF pin) and discharges the output pin through a small internal resistor hence, turning off the load. In instances where the input voltage falls below 1.4 V (typically) the under voltage lock-out circuitry protects the MOSFET switch from entering the saturation region or operation by shutting down the chip.

**APPLICATION INFORMATION**

**Input Capacitor**

While a bypass capacitor on the input is not required, a 1  $\mu$ F or larger capacitor for  $C_{IN}$  is recommended in almost all applications. The Bypass capacitor should be placed as physically close as possible to the SiP4282 to be effective in minimizing transients on the input. Ceramic capacitors are recommended over tantalum because of their ability to withstand input current surges from low impedance sources such as batteries in portable devices.

**Output Capacitor**

A 0.1  $\mu$ F capacitor or larger across  $V_{OUT}$  and GND is recommended to insure proper slew operation.  $C_{OUT}$  may be increased without limit to accommodate any load transient condition with only minimal affect on the SiP4282 turn on slew rate time. There are no ESR or capacitor type requirement.

**Enable**

The ON/OFF pin is compatible with both TTL and CMOS logic voltage levels.

### Protection Against Reverse Voltage Condition

The P-channel MOSFET pass transistor has an intrinsic diode that is reversed biased when the input voltage is greater than the output voltage. Should  $V_{OUT}$  exceed  $V_{IN}$ , this intrinsic diode will become forward biased and allow excessive current to flow into the IC thru the  $V_{OUT}$  pin and potentially damage the IC device. Therefore extreme care should be taken to prevent  $V_{OUT}$  from exceeding  $V_{IN}$ .

In conditions where  $V_{OUT}$  exceeds  $V_{IN}$  a Schottky diode in parallel with the internal intrinsic diode is recommended to protect the SiP4282.

### Thermal Considerations

The SiP4282 is designed to maintain a constant output load current. Due to physical limitations of the layout and assembly of the device the maximum switch current is 1.2 A, as stated in the ABS MAX table. However, another limiting characteristic for the safe operating load current is the thermal power dissipation of the package. To obtain the highest power dissipation (and a thermal resistance of 90 °C/W) the power pad of the device should be connected to a heat sink on the printed circuit board.

The maximum power dissipation in any application is dependant on the maximum junction temperature,  $T_{J(MAX)} = 125$  °C, the junction-to-ambient thermal resistance for the SC-75 PPAK package,  $\theta_{J-A} = 90$  °C/W, and the ambient temperature,  $T_A$ , which may be formulaically expressed as:

$$P (max) = \frac{T_J (max) - T_A}{\theta_{J-A}} = \frac{125 - T_A}{90}$$

It then follows that, assuming an ambient temperature of 70 °C, the maximum power dissipation will be limited to about 610 mW.

So long as the load current is below the 1.2 A limit, the maximum continuous switch current becomes a function two things: the package power dissipation and the  $R_{DS(ON)}$  at the ambient temperature.

As an example let us calculate the worst case maximum load current at  $T_A = 70$  °C. The worst case  $R_{DS(ON)}$  at 25 °C occurs at an input voltage of 1.8 V and is equal to 480 mΩ. The  $R_{DS(ON)}$  at 70 °C can be extrapolated from this data using the following formula

$$R_{DS(ON)} (at 70 \text{ } ^\circ\text{C}) = R_{DS(ON)} (at 25 \text{ } ^\circ\text{C}) \times (1 + T_C \times \Delta T)$$

Where  $T_C$  is 3300 ppm/°C. Continuing with the calculation we have

$$R_{DS(ON)} (at 70 \text{ } ^\circ\text{C}) = 480 \text{ m}\Omega \times (1 + 0.0033 \times (70 \text{ } ^\circ\text{C} - 25 \text{ } ^\circ\text{C})) = 551 \text{ m}\Omega$$

The maximum current limit is then determined by

$$I_{LOAD} (max) < \sqrt{\frac{P (max)}{R_{DS(ON)}}}$$

which in case is 1.05 A. Under the stated input voltage condition, if the 1.05 A current limit is exceeded the internal die temperature will rise and eventually, possibly damage the device.





## Notice

Specifications of the products displayed herein are subject to change without notice. Vishay Intertechnology, Inc., or anyone on its behalf, assumes no responsibility or liability for any errors or inaccuracies.

Information contained herein is intended to provide a product description only. No license, express or implied, by estoppel or otherwise, to any intellectual property rights is granted by this document. Except as provided in Vishay's terms and conditions of sale for such products, Vishay assumes no liability whatsoever, and disclaims any express or implied warranty, relating to sale and/or use of Vishay products including liability or warranties relating to fitness for a particular purpose, merchantability, or infringement of any patent, copyright, or other intellectual property right.

The products shown herein are not designed for use in medical, life-saving, or life-sustaining applications. Customers using or selling these products for use in such applications do so at their own risk and agree to fully indemnify Vishay for any damages resulting from such improper use or sale.