



■ General Description

The AME8802 family of positive, linear regulators feature low quiescent current (30µA typ.) with low dropout voltage, making them ideal for battery applications. The space-saving SOT-23-5 package is attractive for "Pocket" and "Hand Held" applications.

These rugged devices have both Thermal Shutdown, and Current Fold-back to prevent device failure under the "Worst" of operating conditions.

An additional feature is a "Power Good" detector, which pulls low when the output is out of regulation.

The AME8802 is stable with an output capacitance of 2.2µF or greater.

■ Features

- Very Low Dropout Voltage
- Guaranteed 300mA Output
- Accurate to within 1.5%
- 30µA Quiescent Current
- Over-Temperature Shutdown
- Current Limiting
- Short Circuit Current Fold-back
- Power Good Output Function
- Power-Saving Shutdown Mode
- Space-Saving SOT-25 (SOT-23-5)
- Factory Pre-set Output Voltages
- Low Temperature Coefficient

■ Applications

- Instrumentation
- Portable Electronics
- Wireless Devices
- Cordless Phones
- PC Peripherals
- Battery Powered Widgets
- Electronic Scales

■ Functional Block Diagram

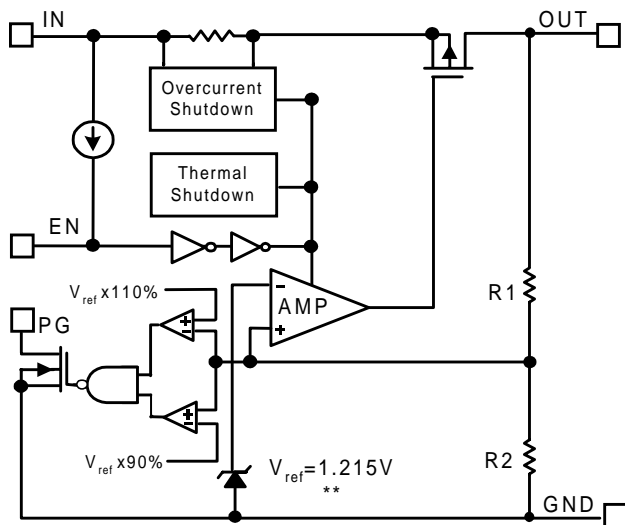

** If output voltage specification is lower than 1.215V, Vref will be trimmed to 1.2V.

■ Typical Application

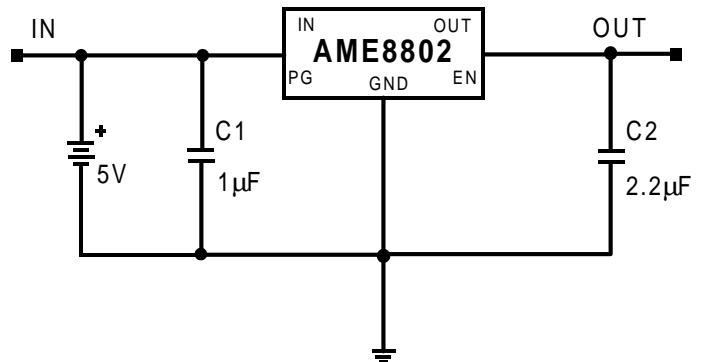



■ Pin Configuration

SOT-25 Top View

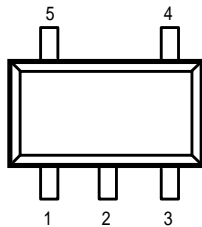

- 1. V_{IN}
- 2. GND
- 3. EN
- 4. PG
- 5. OUT

■ Ordering Information

Part Number	Marking	Output Voltage	Package	Operating Temp. Range
AME8802AEEV	AAKww	3.3V	SOT-25	-40°C to +85°C
AME8802BEEV	AALww	3.0V	SOT-25	-40°C to +85°C
AME8802CEEV	AAMww	2.8V	SOT-25	-40°C to +85°C
AME8802DEEV	AANww	2.5V	SOT-25	-40°C to +85°C
AME8802EEEV	AAOww	3.8V	SOT-25	-40°C to +85°C
AME8802FEEV	ABPww	3.6V	SOT-25	-40°C to +85°C
AME8802GEEV	ACGww	3.5V	SOT-25	-40°C to +85°C
AME8802HEEV	AEHww	2.7V	SOT-25	-40°C to +85°C
AME8802IEEV	AEPww	3.4V	SOT-25	-40°C to +85°C
AME8802JEEV	AGRww	2.85V	SOT-25	-40°C to +85°C
AME8802KEEV	AHTww	3.7V	SOT-25	-40°C to +85°C
AME8802LEEV	AJMww	1.5V	SOT-25	-40°C to +85°C
AME8802MEEV	AJNww	1.8V	SOT-25	-40°C to +85°C
AME8802NEEV	AKQww	2.9V	SOT-25	-40°C to +85°C
AME8802OEEV	AKRww	3.1V	SOT-25	-40°C to +85°C
AME8802TEEV	ARVww	1.2V	SOT-25	-40°C to +85°C
AME8802UEEV	ASDww	3.2V	SOT-25	-40°C to +85°C

represents the date code

Please consult AME sales office or authorized Rep./Distributor for other output voltage and package type availability.



■ Absolute Maximum Ratings

Parameter	Maximum	Unit
Input Voltage	8	V
Output Current	$P_D / (V_{IN} - V_O)$	mA
Output Voltage	GND - 0.3 to $V_{IN} + 0.3$	V
ESD Classification	B	

■ Recommended Operating Conditions

Parameter	Rating	Unit
Ambient Temperature Range	-40 to +85	°C
Junction Temperature	-40 to +125	°C

■ Thermal Information

Parameter		Maximum	Unit
Thermal Resistance (θ_{ja})	SOT-25	260	°C / W
Internal Power Dissipation (P_D) ($\Delta T = 100^\circ\text{C}$)	SOT-25	380	mW
Maximum Junction Temperature		150	°C
Maximum Lead Temperature (10 Sec)		300	°C

Caution: Stress above the listed absolute rating may cause permanent damage to the device



Electrical Specifications

TA = 25° C unless otherwise noted

Parameter	Symbol	Test Condition	Min	Typ	Max	Units	
Input Voltage	V _{IN}		Note 1		7	V	
Output Voltage Accuracy	V _O	I _O =1mA	-1.5		1.5	%	
Dropout Voltage	V _{DROPOUT}	I _O =300mA V _O =V _{ONOM} -2.0%	1.2V < V _{O(NOM)} <= 2.0V	See chart	1300	mV	
			2.0V < V _{O(NOM)} <= 2.8V		400		
			2.8V < V _{O(NOM)}		300		
Output Current	I _O	V _O >1.2V	300			mA	
Current Limit	I _{LIM}	V _O >1.2V	300	450		mA	
Short Circuit Current	I _{SC}	V _O <0.8V		150	300	mA	
Quiescent Current	I _Q	I _O =0mA		30	50	μA	
Ground Pin Current	I _{GND}	I _O =1mA to 300mA		35		μA	
Line Regulation	REG _{LINE}	I _O =1mA V _{IN} =V _O +1 to V _O +2	V _O < 2.0V	-0.15		0.15	%
			2.0V <= V _O < 4.0V	-0.1	0.02	0.1	%
			4.0V <= V _O	-0.4	0.2	0.4	%
Load Regulation	REG _{LOAD}	I _O =1mA to 300mA	-1	0.2	1	%	
Over Temperature Shutdown	OTS			150		°C	
Over Temperature Hysterisis	OTH			30		°C	
V _O Temperature Coefficient	TC			30		ppm/°C	
Power Supply Rejection	PSRR	I _O =100mA C _O =2.2μF	f=1kHz		50	dB	
			f=10kHz		20		
			f=100kHz		15		
Output Voltage Noise	e _N	f=10Hz to 100kHz I _O =10mA			30	μVrms	
EN Input Threshold	V _{EH}	V _{IN} =2.7V to 7V	2.0		V _{in}	V	
	V _{EL}	V _{IN} =2.7V to 7V	0		0.4	V	
EN Input Bias Current	I _{EH}	V _{EN} =V _{IN} , V _{IN} =2.7V to 7V			0.1	μA	
	I _{EL}	V _{EN} =0V, V _{IN} =2.7V to 7V			0.5	μA	
Shutdown Supply Current	I _{SD}	V _{IN} =5V, V _O =0V, V _{EN} <V _{EL}		0.5	1	μA	
Shutdown Output Voltage	V _{O,SD}	I _O =0.4mA, V _{EN} <V _{EL}	0		0.4	V	
Output Under Voltage	V _{UV}	2.5V <= V _O <= 5.0V			85	%V _{O(NOM)}	
		1.2V <= V _O < 2.5V			75		
Output Over Voltage	V _{OV}	2.5V <= V _O <= 5.0V	115			%V _{O(NOM)}	
		1.2V <= V _O < 2.5V	125				
PG Leakage Current	I _{LC}	V _{PG} =7V			1	μA	
PG Voltage Rating	V _{PG}	V _O in regulation			7	V	
PG Voltage Low	V _{OL}	I _{SINK} =0.4mA			0.4	V	

Note1: V_{IN(min)}=V_{OUT}+V_{DROPOUT}



■ Detailed Description

The AME8802 family of CMOS regulators contain a PMOS pass transistor, voltage reference, error amplifier, over-current protection, thermal shutdown, and power good function.

The P-channel pass transistor receives data from the error amplifier, over-current shutdown, and thermal protection circuits. During normal operation, the error amplifier compares the output voltage to a precision reference. Over-current and Thermal shutdown circuits become active when the junction temperature exceeds 150°C, or the current exceeds 300mA. During thermal shutdown, the output voltage remains low. Normal operation is restored when the junction temperature drops below 120°C.

The AME8802 switches from voltage mode to current mode when the load exceeds the rated output current. This prevents over-stress. The AME8802 also incorporates current foldback to reduce power dissipation when the output is short circuited. This feature becomes active when the output drops below 0.8volts, and reduces the current flow by 65%. Full current is restored when the voltage exceeds 0.8 volts.

■ External Capacitors

The AME8802 is stable with an output capacitor to ground of 2.2 μ F or greater. Ceramic capacitors have the lowest ESR, and will offer the best AC performance. Conversely, Aluminum Electrolytic capacitors exhibit the highest ESR, resulting in the poorest AC response. Unfortunately, large value ceramic capacitors are comparatively expensive. One option is to parallel a 0.1 μ F ceramic capacitor with a 10 μ F Aluminum Electrolytic. The benefit is low ESR, high capacitance, and low overall cost.

A second capacitor is recommended between the input and ground to stabilize V_{in} . The input capacitor should be at least 0.1 μ F to have a beneficial effect.

All capacitors should be placed in close proximity to the pins. A "Quiet" ground termination is desirable. This can be achieved with a "Star" connection.

■ Enable

The Enable pin normally floats high. When actively, pulled low, the PMOS pass transistor shuts off, and all internal circuits are powered down. In this state, the quiescent current is less than 1 μ A. This pin behaves much like an electronic switch.

■ Power Good

The AME8802 includes the Power Good feature. Normally, Pin 4 is "Floating", however, when the output is not within $\pm 10\%$ of the specified voltage, it pulls low. This can occur under the following conditions:

- 1) Input Voltage too low.
- 2) During Over-Temperature.
- 3) During Over-Current.
- 4) If output is pulled up.

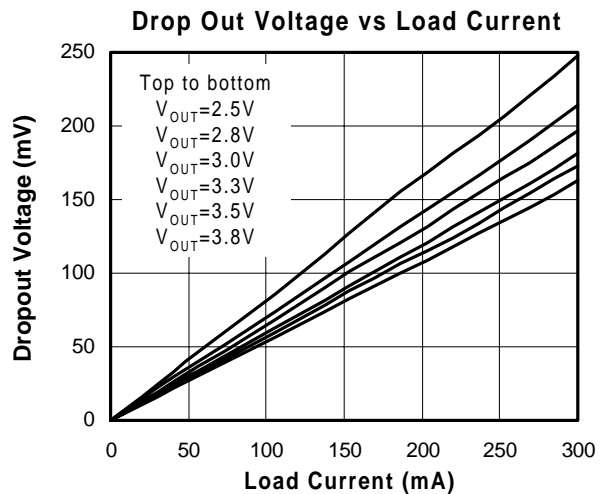
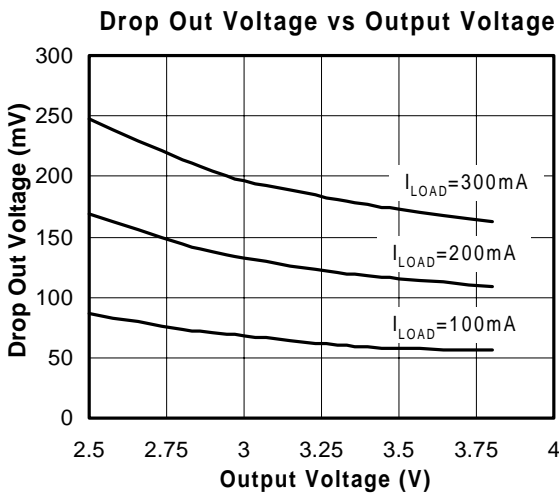
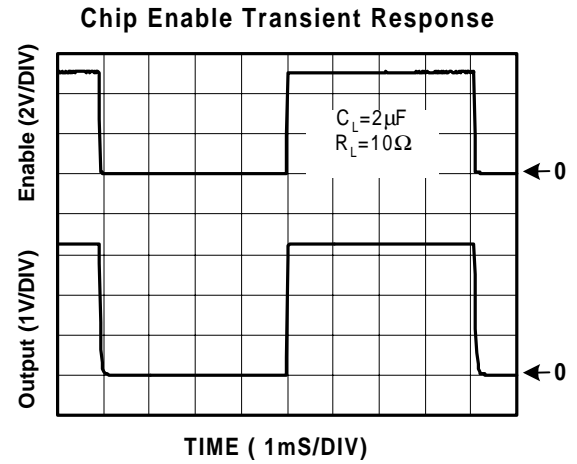
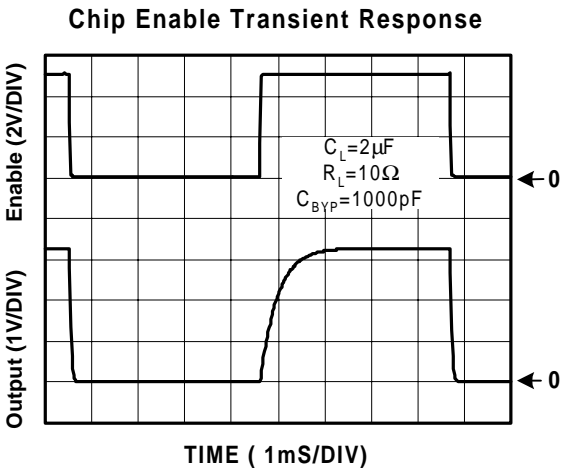
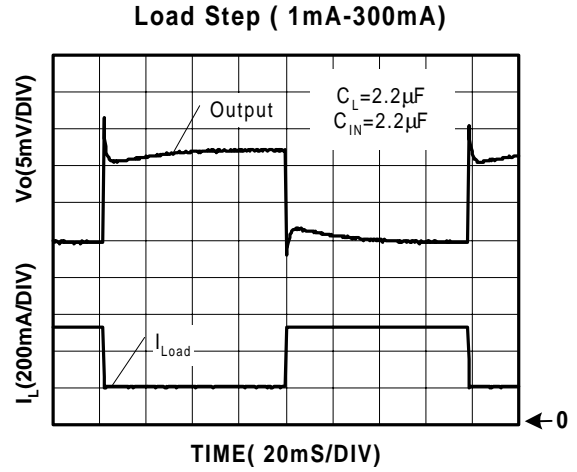
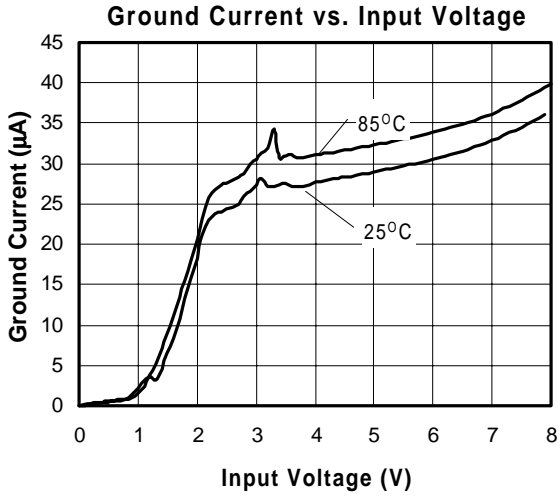



Power Supply Rejection Ratio

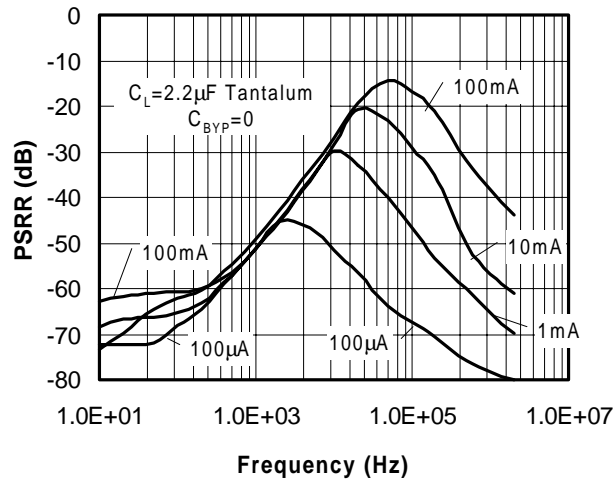

Short Circuit Response

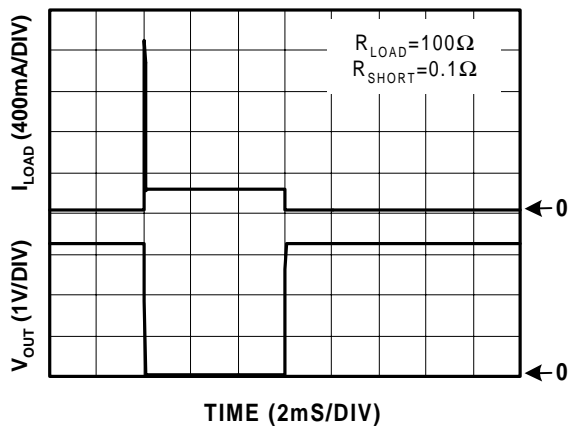

Overtemperature Shutdown

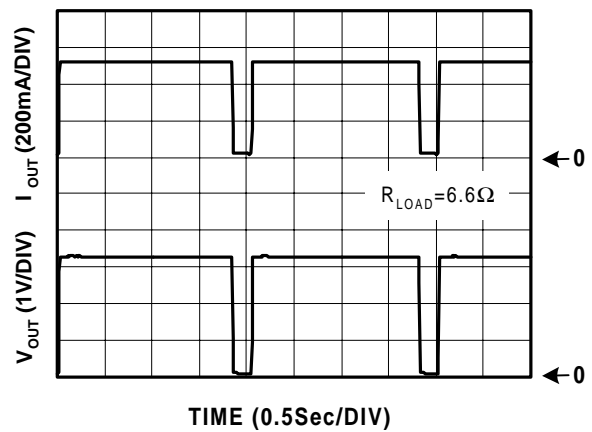

Current Limit Response

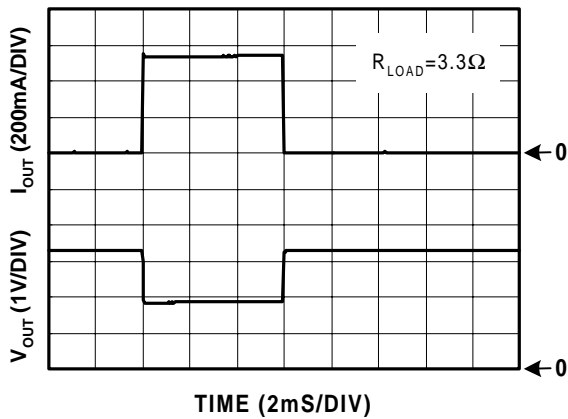

Noise Measurement

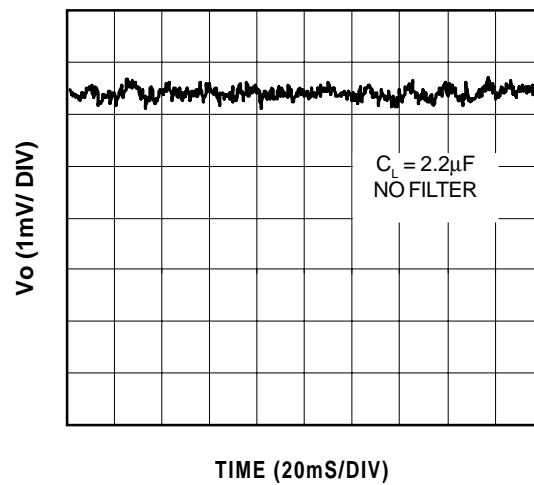

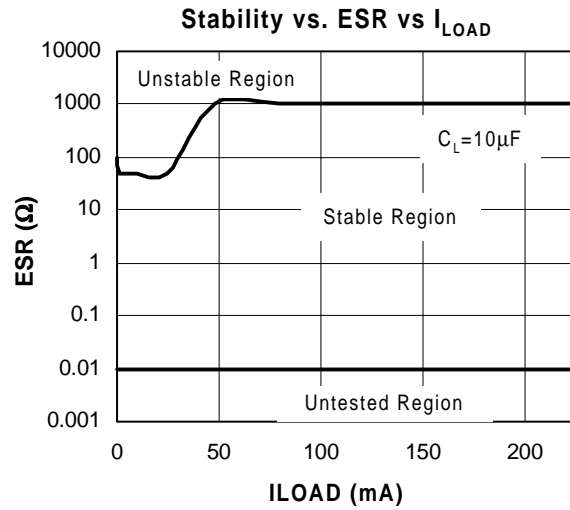
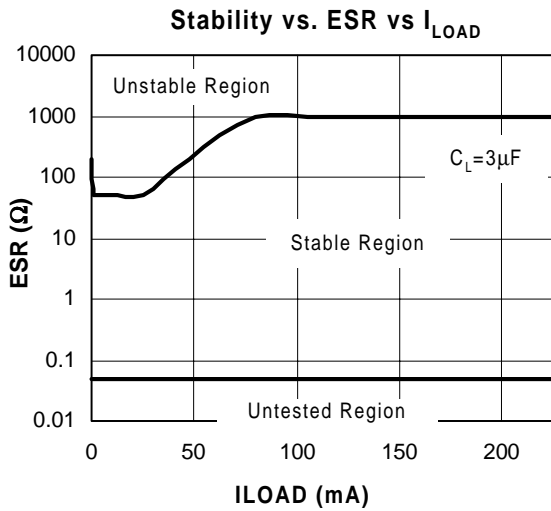
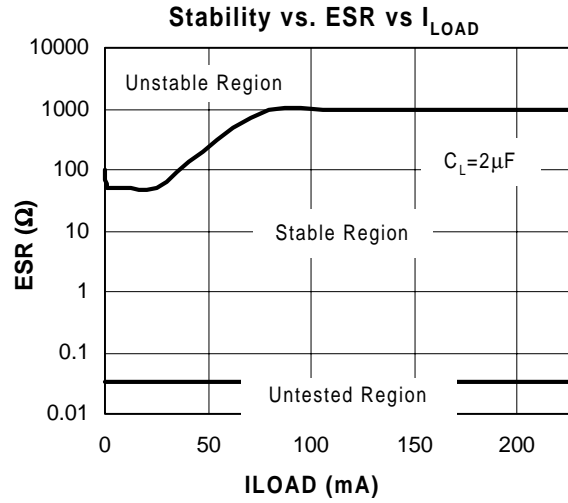
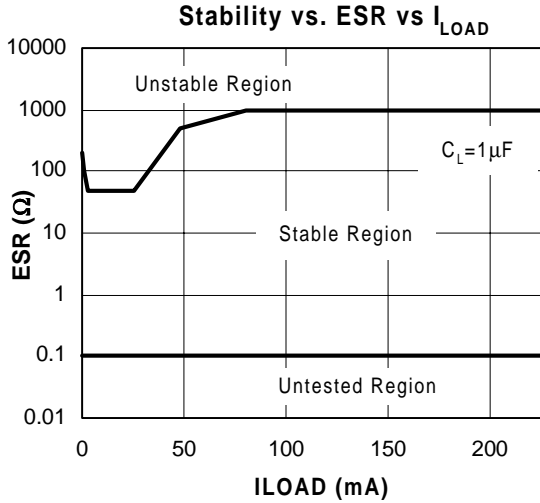

Transient Line Response

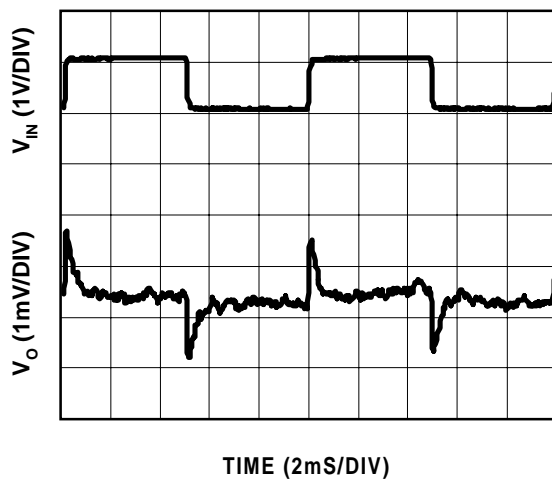

Safe Operating Area

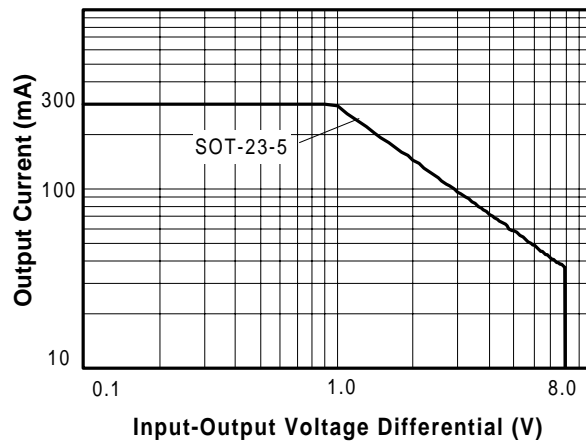

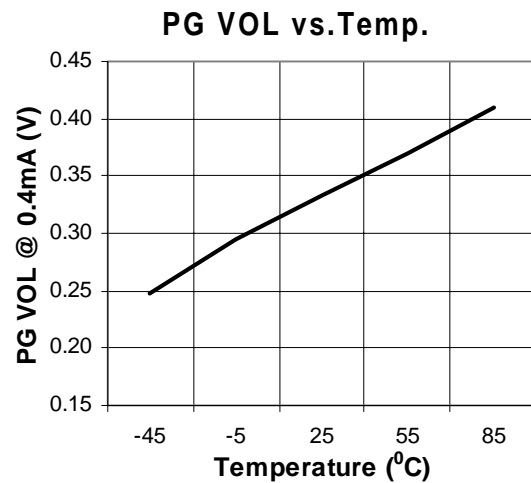
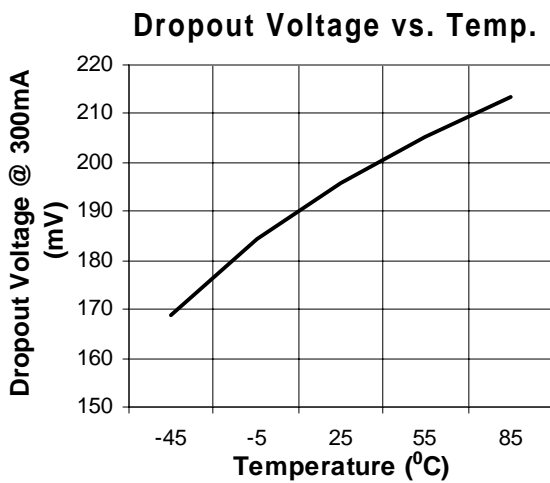
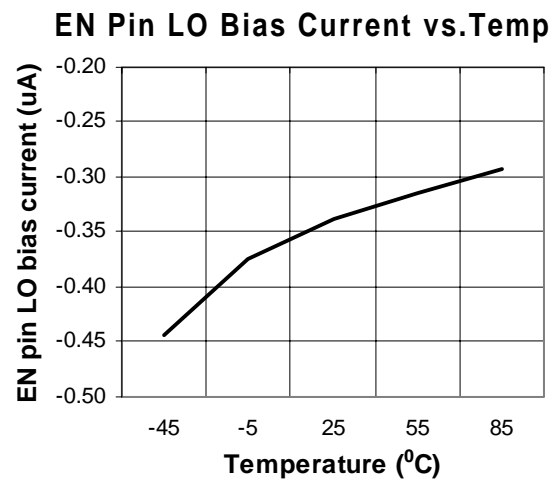
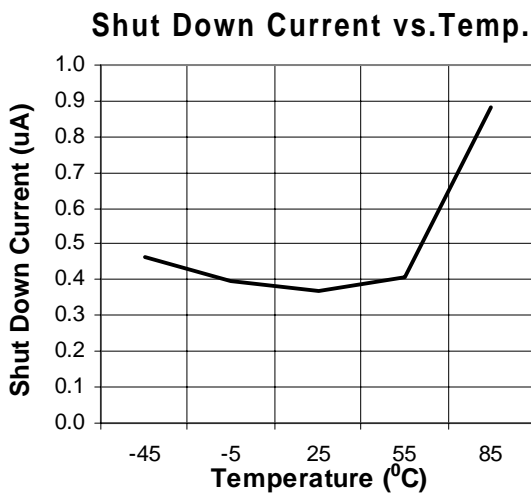
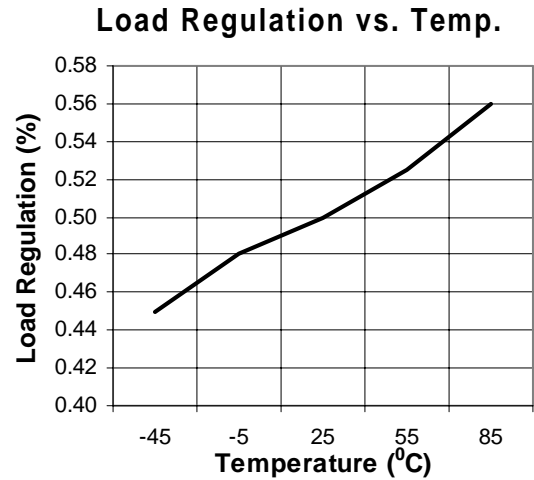
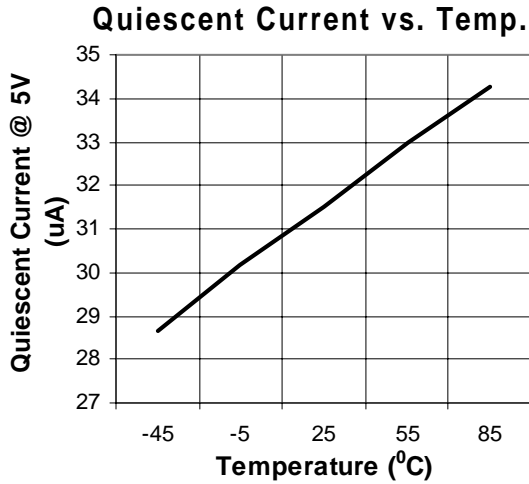



■ Package Dimension

SOT-25

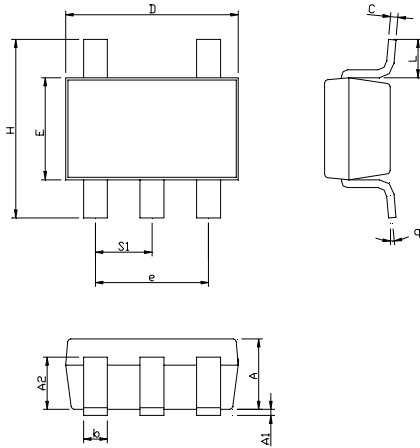

SYMBOLS	MILLIMETERS		INCHES	
	MIN	MAX	MIN	MAX
A	1.00	1.45	0.0394	0.0571
A ₁	0.00	0.15	0.0000	0.0591
A ₂	0.70	1.25	0.0276	0.0492
b	0.35	0.55	0.0138	0.0217
C	0.08	0.25	0.0031	0.0098
D	2.70	3.10	0.1063	0.1220
E	1.40	1.80	0.0551	0.0709
e	1.90 BSC		0.07480 BSC	
H	2.60	3.00	0.1024	0.1181
L	0.30	-	0.0118	-
θ ₁	0°	10°	0°	10°
S ₁	0.85	1.05	0.0335	0.0413



www.analogmicro.com
E-Mail: info@analogmicro.com

Life Support Policy:

These products of Analog Microelectronics, Inc. are not authorized for use as critical components in life-support devices or systems, without the express written approval of the president of Analog Microelectronics, Inc.

Analog Microelectronics, Inc. reserves the right to make changes in the circuitry and specifications of its devices and advises its customers to obtain the latest version of relevant information.

© Analog Microelectronics, Inc., August 2001

Document: 2006-DS8802-E

Corporate Headquarters
Analog Microelectronics, Inc.

3100 De La Cruz Blvd. Suite 201
Santa Clara, CA. 95054-2046
Tel : (408) 988-2388
Fax: (408) 988-2489

Asia Pacific Headquarters
AME, Inc.

2F, 187 Kang-Chien Road, Nei-Hu District
Taipei 114, Taiwan, R.O.C.
Tel : 886 2 2627-8687
Fax: 886 2 2659-2989