

RF AMP. FOR UHF TV TUNER
N-CHANNEL SILICON DUAL-GATE MOS FIELD-EFFECT TRANSISTOR
4PIN MINI MOLD

FEATURES

- Suitable for use as RF amplifier in UHF TV tuner.
- Low C_{rss} : 0.02 pF TYP.
- High G_{ps} : 18 dB TYP.
- Low NF : 2.7 dB TYP.

ABSOLUTE MAXIMUM RATINGS ($T_A = 25\text{ }^\circ\text{C}$)

Drain to Source Voltage	V_{DSX}	20	V
Gate1 to Source Voltage	V_{G1S}^*	± 10	V
Gate2 to Source Voltage	V_{G2S}^*	± 10	V
Drain Current	I_D	25	mA
Total Power Dissipation	P_T	200	mW
Channel Temperature	T_{ch}	150	$^\circ\text{C}$
Storage Temperature	T_{stg}	-65 to +150	$^\circ\text{C}$

* $R_L \geq 10\text{ k}\Omega$

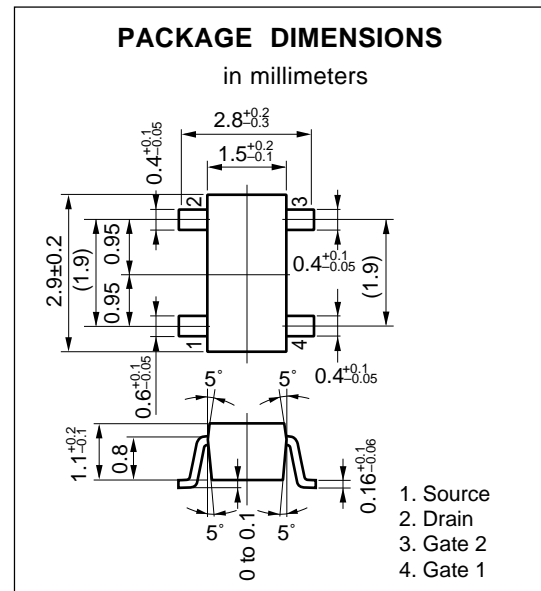

ELECTRICAL CHARACTERISTICS ($T_A = 25\text{ }^\circ\text{C}$)

CHARACTERISTIC	SYMBOL	MIN.	TYP.	MAX.	UNIT	TEST CONDITIONS
Drain to Source Breakdown Voltage	BV_{DSX}	20			V	$V_{G1S} = V_{G2S} = -2\text{ V}$, $I_D = 10\text{ }\mu\text{A}$
Drain Current	I_{DSS}	0.01		6	mA	$V_{DS} = 5\text{ V}$, $V_{G2S} = 4\text{ V}$, $V_{G1S} = 0$
Gate1 to Source Cutoff Voltage	$V_{G1S(off)}$			-2.0	V	$V_{DS} = 10\text{ V}$, $V_{G2S} = 4\text{ V}$, $I_D = 10\text{ }\mu\text{A}$
Gate2 to Source Cutoff Voltage	$V_{G2S(off)}$			-0.7	V	$V_{DS} = 10\text{ V}$, $V_{G1S} = 4\text{ V}$, $I_D = 10\text{ }\mu\text{A}$
Gate1 Reverse Current	I_{G1SS}			± 20	nA	$V_{DS} = 0$, $V_{G1S} = \pm 8\text{ V}$, $V_{G2S} = 0$
Gate2 Reverse Current	I_{G2SS}			± 20	nA	$V_{DS} = 0$, $V_{G2S} = \pm 8\text{ V}$, $V_{G1S} = 0$
Forward Transfer Admittance	$ y_{fs} $	14	18		ms	$V_{DS} = 5\text{ V}$, $V_{G2S} = 4\text{ V}$, $I_D = 10\text{ mA}$, $f = 1\text{ kHz}$
Input Capacitance	C_{iss}	1.5		2.5	pF	$V_{DS} = 10\text{ V}$, $V_{G2S} = 4\text{ V}$, $I_D = 10\text{ mA}$, $f = 1\text{ MHz}$
Output capacitance	C_{oss}	0.5	1.0	1.5	pF	
Reverse Transfer Capacitance	C_{rss}		0.02	0.03	pF	
Power Gain	G_{ps}^*	16	18		dB	$V_{DS} = 10\text{ V}$, $V_{G2S} = 4\text{ V}$, $I_D = 10\text{ mA}$, $f = 900\text{ MHz}$
Noise Figure	NF*		2.7	4.5	dB	

I_{DSS} Classification

Class	L/LS*	K/KS*
Marking	U65	U66
I_{DSS}	0.01 to 2	1 to 6

* Old specification/New specification

TYPICAL CHARACTERISTICS (T_A = 25 °C)

TOTAL POWER DISSIPATION vs. AMBIENT TEMPERATURE

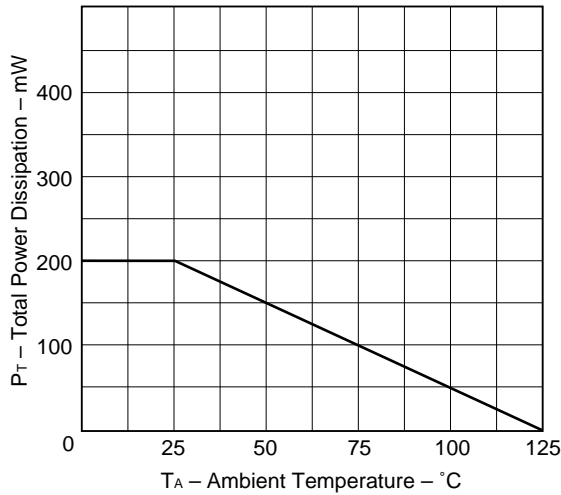

DRAIN CURRENT vs. DRAIN TO SOURCE VOLTAGE

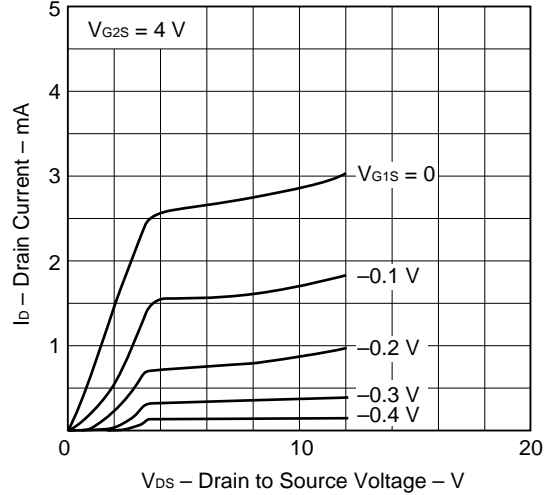

DRAIN CURRENT vs. GATE 1 TO SOURCE VOLTAGE

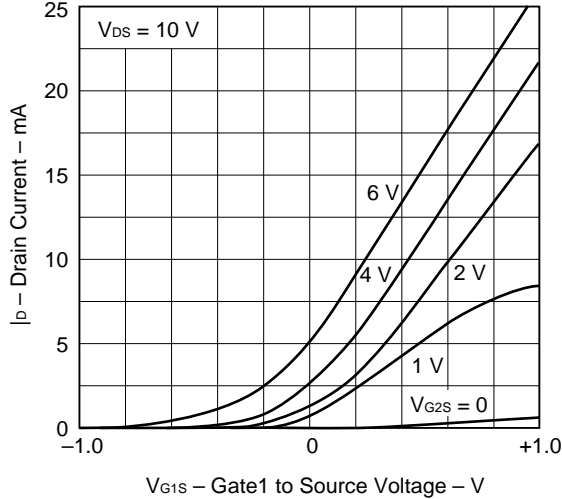

FORWARD TRANSFER ADMITTANCE vs. GATE 1 TO SOURCE VOLTAGE

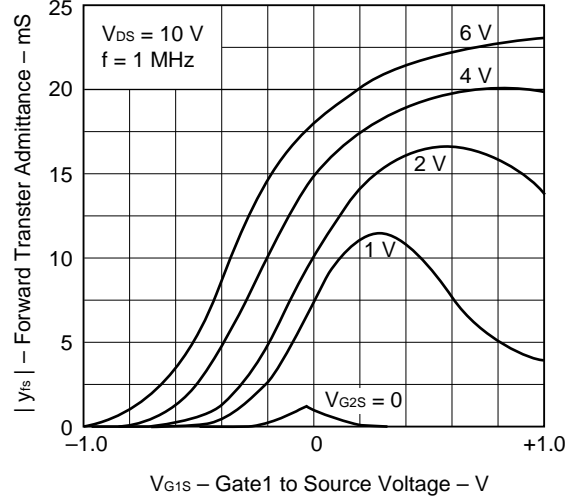

INPUT CAPACITANCE vs. DRAIN CURRENT

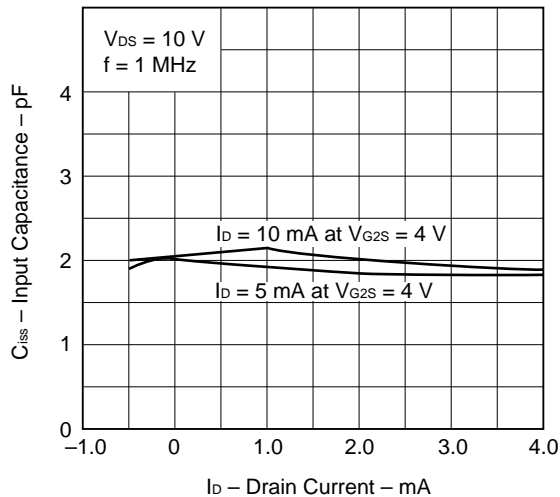

OUTPUT CAPACITANCE vs. GATE 2 TO SOURCE VOLTAGE

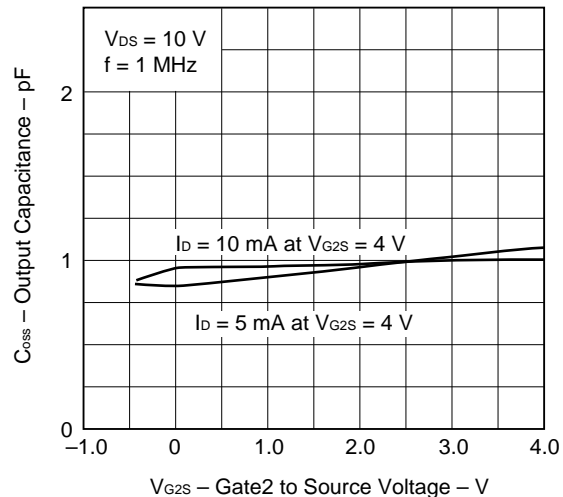

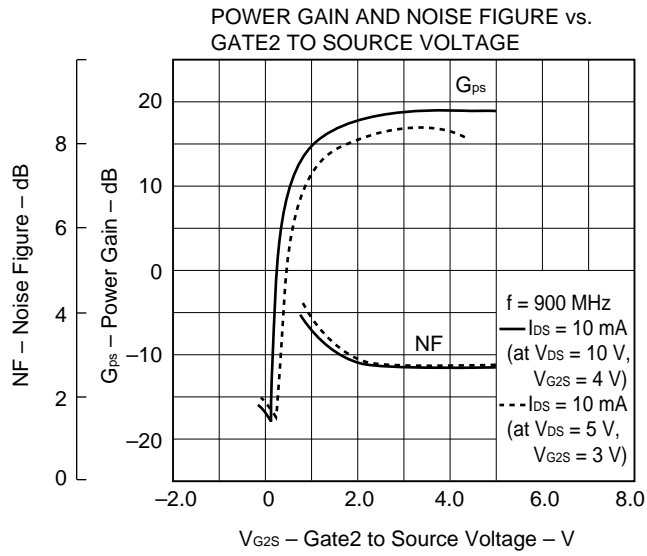

S-PARAMETER, Y-PARAMETER

S1, Y1		S1-MAG & ANGL							
CONDITION	FREQ.	11	21	12	22	11	21	12	22
$V_{DS} = 10\text{ V}$ $V_{G2S} = 4\text{ V}$ $I_{DS} = 10\text{ mA}$	50	1.023	-2	1.820	173	0.002	86	1.023	0
	100	0.989	-8	1.758	165	0.002	102	0.977	-4
	200	0.966	-11	1.778	153	0.003	56	0.977	-7
	300	0.923	-22	1.758	139	0.003	167	0.966	-10
	400	0.871	-23	1.758	128	0.008	-153	0.933	-11
	500	0.841	-33	1.718	113	0.017	-160	0.912	-15
	600	0.776	-34	1.738	101	0.034	-166	0.902	-15
	700	0.676	-41	1.718	88	0.058	-178	0.891	-18
	800	0.631	-43	1.698	76	0.089	173	0.881	-21
	900	0.575	-47	1.660	64	0.130	160	0.881	-20
1000	0.537	-49	1.567	48	0.172	142	0.891	-34	

Y1-MAG & ANGL		Y1-MAG & ANGL							
FREQ.	11	21	12	22	11	21	12	22	
50	0.405	125	17.780	-6	0.020	-93	0.234	-176	
100	1.382	85	17.940	-9	0.024	-72	0.715	71	
200	1.937	80	18.399	-18	0.027	-115	1.226	80	
300	3.962	77	19.044	-26	0.033	2	1.773	78	
400	4.327	69	20.003	-36	0.086	43	2.069	68	
500	6.197	71	20.688	-45	0.205	42	2.801	67	
600	6.589	62	21.986	-58	0.434	35	2.754	60	
700	8.151	53	23.697	-69	0.803	25	2.973	58	
800	8.287	47	24.190	-81	1.269	16	2.985	59	
900	8.404	44	23.916	-94	1.878	2	2.079	65	
1000	8.085	46	22.726	-103	2.492	-9	4.327	90	

S2, Y2		S2-MAG & ANGL							
CONDITION	FREQ.	11	21	12	22	11	21	12	22
$V_{DS} = 10\text{ V}$ $V_{G2S} = 4\text{ V}$ $I_{DS} = 5\text{ mA}$	50	1.023	-2	1.567	174	0.002	64	1.035	0
	100	0.989	-8	1.531	166	0.003	118	0.989	-4
	200	0.966	-11	1.549	153	0.003	49	0.977	-7
	300	0.933	-22	1.531	140	0.003	177	0.977	-10
	400	0.891	-23	1.567	129	0.008	-148	0.944	-11
	500	0.851	-34	1.531	114	0.017	-157	0.923	-15
	600	0.794	-35	1.567	102	0.035	-161	0.912	-16
	700	0.684	-43	1.549	88	0.062	-174	0.902	-19
	800	0.624	-46	1.549	76	0.095	176	0.891	-22
	900	0.556	-51	1.531	64	0.143	163	0.891	-22
1000	0.501	-52	1.462	48	0.191	144	0.891	-35	

Y2-MAG & ANGL		Y2-MAG & ANGL							
FREQ.	11	21	12	22	11	21	12	22	
50	0.411	126	15.215	-5	0.022	-115	0.354	-178	
100	1.385	85	15.540	-8	0.027	-56	0.690	80	
200	1.940	80	16.026	-18	0.028	-122	1.229	80	
300	3.946	79	16.402	-24	0.032	13	1.759	82	
400	4.259	73	17.533	-35	0.087	48	2.034	71	
500	6.358	72	18.279	-43	0.207	46	2.770	69	
600	6.724	64	19.600	-56	0.444	41	2.914	64	
700	8.534	55	21.366	-67	0.851	31	3.157	62	
800	8.961	48	22.388	-79	1.380	21	3.168	61	
900	9.289	43	22.717	-92	2.120	7	2.336	67	
1000	8.676	43	21.911	-103	2.855	-7	4.332	90	

900 MHz G_{ps} AND NF TEST CIRCUIT

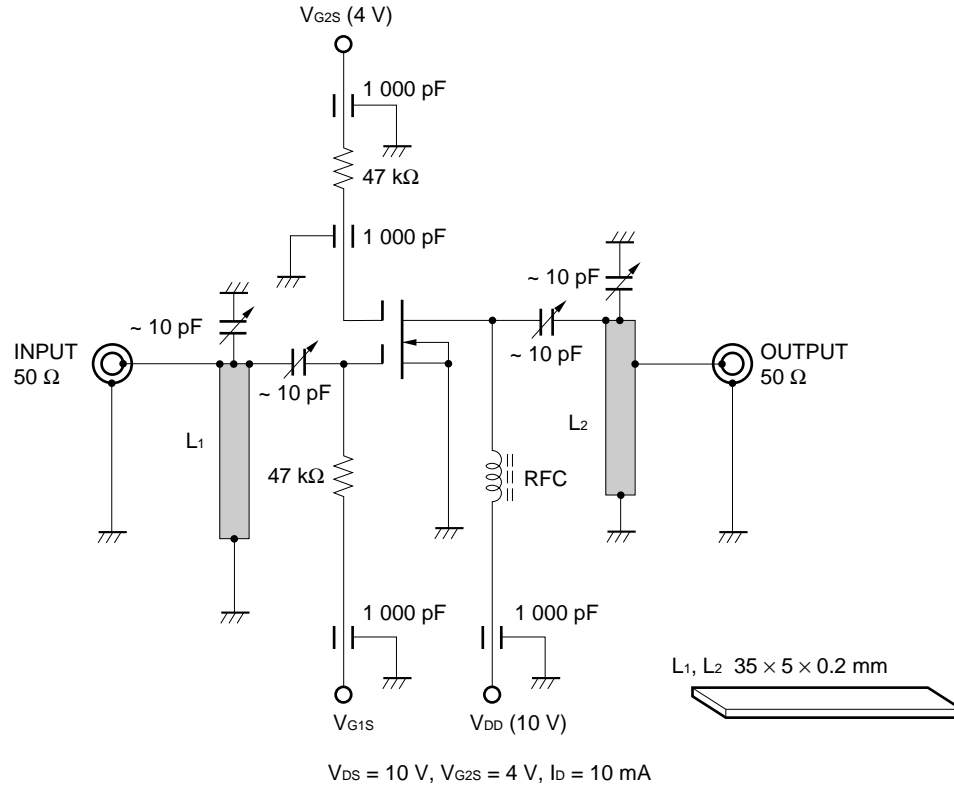

No part of this document may be copied or reproduced in any form or by any means without the prior written consent of NEC Corporation. NEC Corporation assumes no responsibility for any errors which may appear in this document.

NEC Corporation does not assume any liability for infringement of patents, copyrights or other intellectual property rights of third parties by or arising from use of a device described herein or any other liability arising from use of such device. No license, either express, implied or otherwise, is granted under any patents, copyrights or other intellectual property rights of NEC Corporation or others.

While NEC Corporation has been making continuous effort to enhance the reliability of its semiconductor devices, the possibility of defects cannot be eliminated entirely. To minimize risks of damage or injury to persons or property arising from a defect in an NEC semiconductor device, customer must incorporate sufficient safety measures in its design, such as redundancy, fire-containment, and anti-failure features.

NEC devices are classified into the following three quality grades:

"Standard", "Special", and "Specific". The Specific quality grade applies only to devices developed based on a customer designated "quality assurance program" for a specific application. The recommended applications of a device depend on its quality grade, as indicated below. Customers must check the quality grade of each device before using it in a particular application.

Standard: Computers, office equipment, communications equipment, test and measurement equipment, audio and visual equipment, home electronic appliances, machine tools, personal electronic equipment and industrial robots

Special: Transportation equipment (automobiles, trains, ships, etc.), traffic control systems, anti-disaster systems, anti-crime systems, safety equipment and medical equipment (not specifically designed for life support)

Specific: Aircrafts, aerospace equipment, submersible repeaters, nuclear reactor control systems, life support systems or medical equipment for life support, etc.

The quality grade of NEC devices in "Standard" unless otherwise specified in NEC's Data Sheets or Data Books. If customers intend to use NEC devices for applications other than those specified for Standard quality grade, they should contact NEC Sales Representative in advance.

Anti-radioactive design is not implemented in this product.