

## NPN Silicon High-Voltage Transistors

**BFN 16**  
**BFN 18**

- Suitable for video output stages in TV sets and switching power supplies
- High breakdown voltage
- Low collector-emitter saturation voltage
- Complementary types: BFN 17, BFN 19 (PNP)

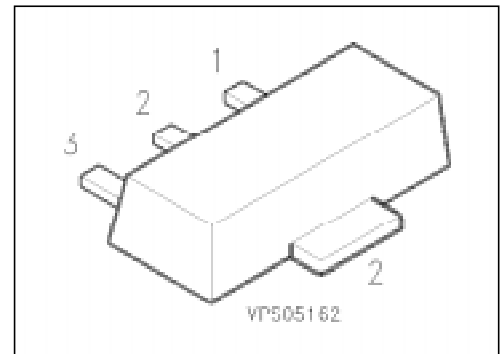

Type	Marking	Ordering Code (tape and reel)	Pin Configuration			Package <sup>1)</sup>
			1	2	3	
BFN 16	DD	Q62702-F885	B	C	E	SOT-89
BFN 18	DE	Q62702-F1056				

### Maximum Ratings

Parameter	Symbol	Values		Unit
		BFN 16	BFN 18	
Collector-emitter voltage	$V_{CE0}$	250	300	V
Collector-base voltage	$V_{CB0}$	250	300	
Emitter-base voltage	$V_{EB0}$	5		
Collector current	$I_C$	200		mA
Peak collector current	$I_{CM}$	500		
Base current	$I_B$	100		
Peak base current	$I_{BM}$	200		
Total power dissipation, $T_s = 130\text{ °C}$	$P_{tot}$	1		W
Junction temperature	$T_j$	150		°C
Storage temperature range	$T_{stg}$	- 65 ... + 150		

### Thermal Resistance

Junction - ambient <sup>2)</sup>	$R_{th\ JA}$	≤ 75	K/W
Junction - soldering point	$R_{th\ JS}$	≤ 20	

<sup>1)</sup> For detailed information see chapter Package Outlines.

<sup>2)</sup> Package mounted on epoxy pcb 40 mm × 40 mm × 1.5 mm/6 cm<sup>2</sup> Cu.

## Electrical Characteristics

at  $T_A = 25\text{ °C}$ , unless otherwise specified.

Parameter	Symbol	Values			Unit
		min.	typ.	max.	

### DC characteristics

Collector-emitter breakdown voltage $I_C = 1\text{ mA}$	BFN 16 BFN 18	$V_{(BR)CE0}$	250 300	– –	– –	V
Collector-base breakdown voltage $I_C = 100\text{ }\mu\text{A}$	BFN 16 BFN 18	$V_{(BR)CB0}$	250 300	– –	– –	
Emitter-base breakdown voltage $I_E = 100\text{ }\mu\text{A}$		$V_{(BR)EB0}$	5	–	–	
Collector-base cutoff current $V_{CB} = 200\text{ V}$ $V_{CB} = 250\text{ V}$ $V_{CB} = 200\text{ V}, T_A = 150\text{ °C}$ $V_{CB} = 250\text{ V}, T_A = 150\text{ °C}$	BFN 16 BFN 18 BFN 16 BFN 18	$I_{CB0}$	– – – –	– – – –	100 100 20 20	nA nA $\mu\text{A}$ $\mu\text{A}$
Emitter-base cutoff current $V_{EB} = 3\text{ V}$		$I_{EB0}$	–	–	100	nA
DC current gain $I_C = 1\text{ mA}, V_{CE} = 10\text{ V}$ $I_C = 10\text{ mA}, V_{CE} = 10\text{ V}^{1)}$ $I_C = 30\text{ mA}, V_{CE} = 10\text{ V}^{1)}$	BFN 16 BFN 18	$h_{FE}$	25 40 40 30	– – – –	– – – –	–
Collector-emitter saturation voltage <sup>1)</sup> $I_C = 20\text{ mA}, I_B = 2\text{ mA}$	BFN 16 BFN 18	$V_{CEsat}$	– –	– –	0.4 0.5	V
Base-emitter saturation voltage <sup>1)</sup> $I_C = 20\text{ mA}, I_B = 2\text{ mA}$		$V_{BEsat}$	–	–	0.9	

### AC characteristics

Transition frequency $I_C = 20\text{ mA}, V_{CE} = 10\text{ V}, f = 20\text{ MHz}$		$f_t$	–	70	–	MHz
Output capacitance $V_{CB} = 30\text{ V}, f = 1\text{ MHz}$		$C_{obo}$	–	1.5	–	pF

<sup>1)</sup> Pulse test conditions:  $t \leq 300\text{ }\mu\text{s}, D = 2\%$ .

### Total power dissipation $P_{tot} = f(T_A^*; T_S)$

\* Package mounted on epoxy

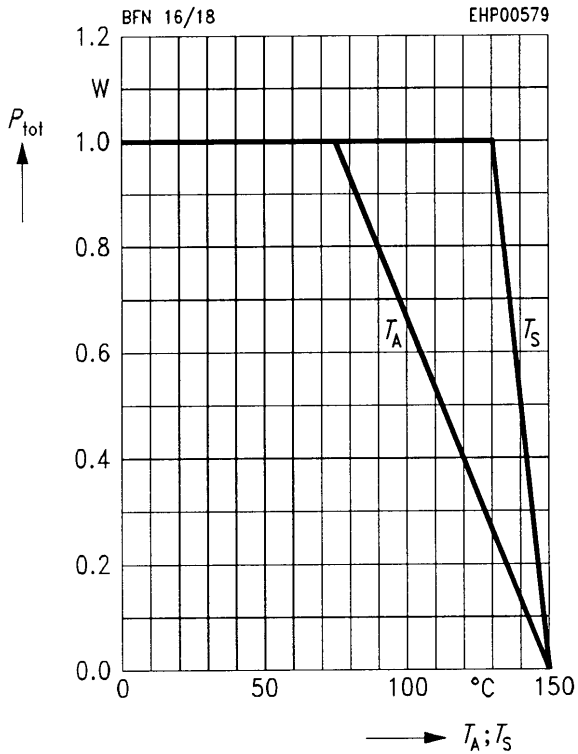

### Operating range $I_C = f(V_{CE0})$

$T_A = 25^\circ\text{C}, D = 0$

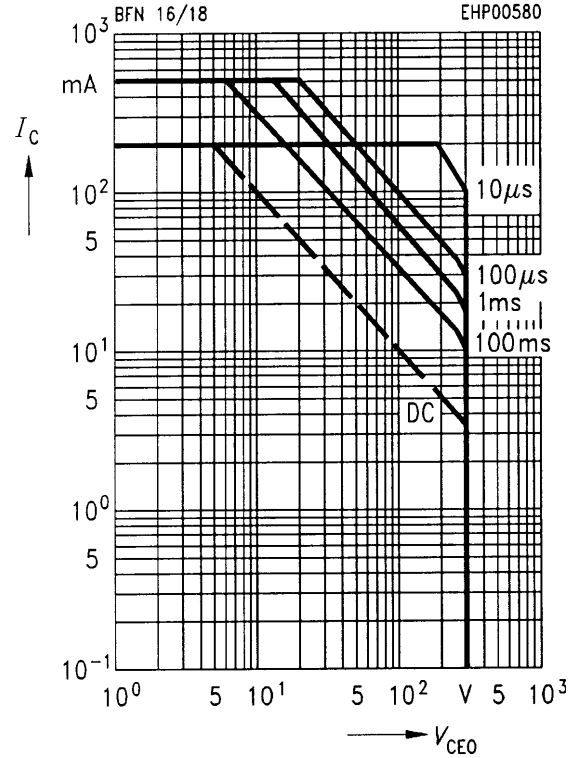

### Permissible pulse load $P_{tot\ max}/P_{tot\ DC} = f(t_p)$

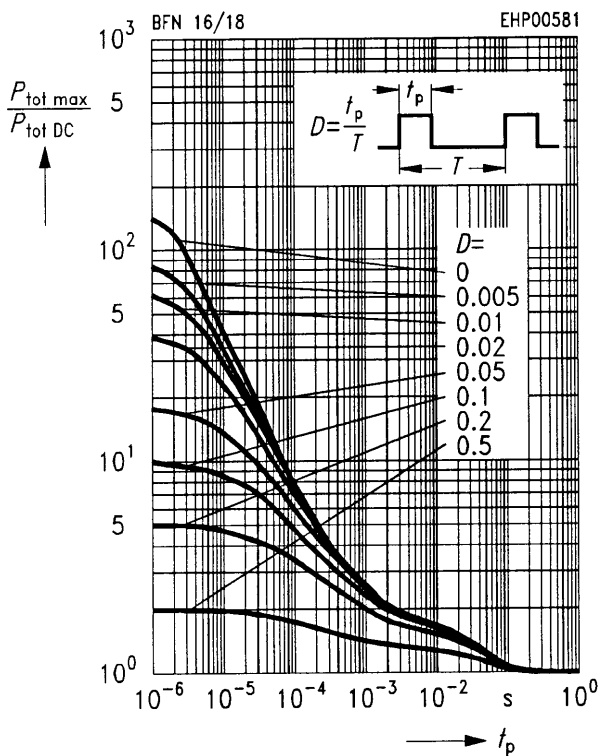

### Collector current $I_C = f(V_{BE})$

$V_{CE} = 10\text{ V}$

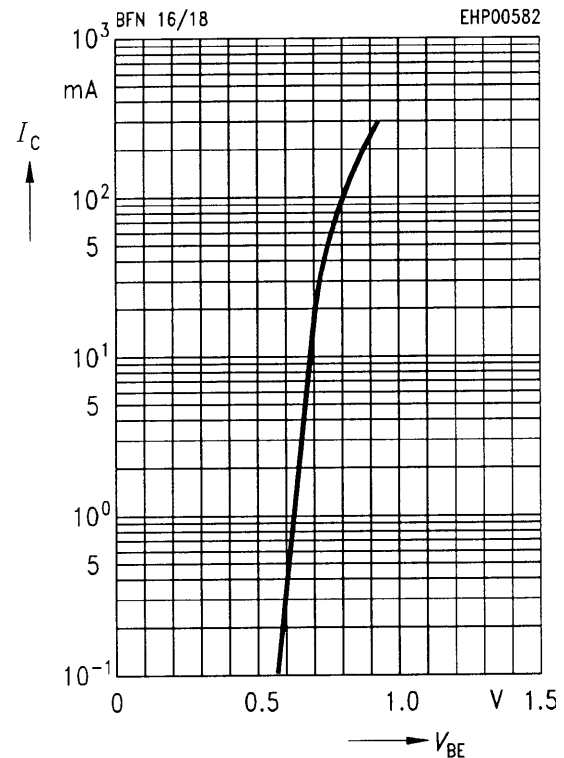

### Transition frequency $f_T = f(I_C)$

$V_{CE} = 10\text{ V}$

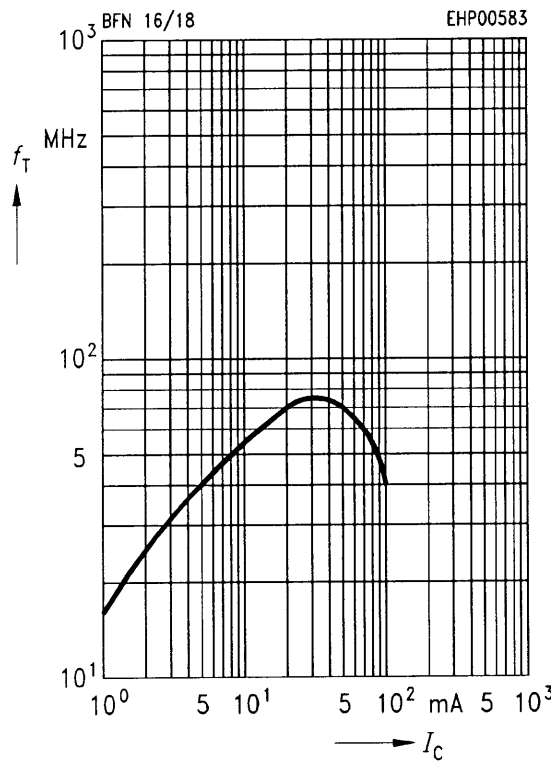

### Collector cutoff current $I_{CB0} = f(T_A)$

$V_{CB} = 200\text{ V}$

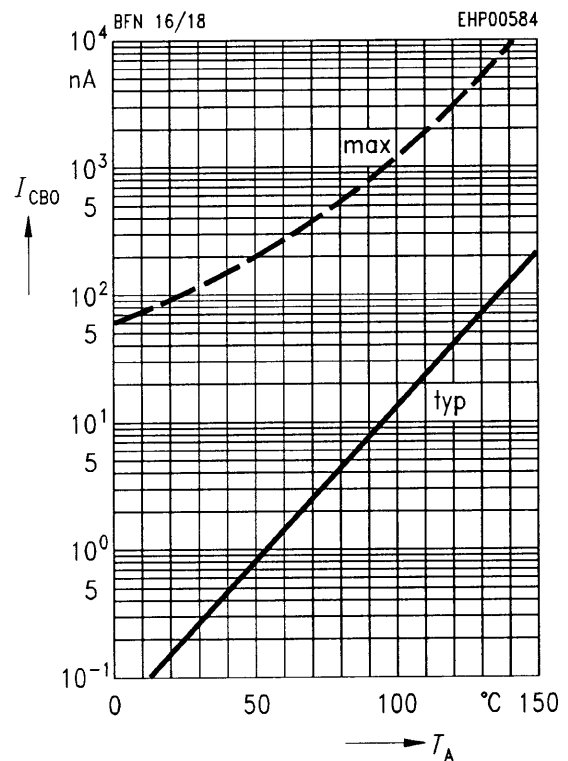

### DC current gain $h_{FE} = f(I_C)$

$V_{CE} = 10\text{ V}$

