

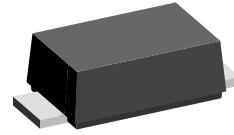

## Small Surface Mount Diodes

### Features

- For surface mounted applications
- Low profile package
- Ideal for automated placement
- Glass passivated
- High temperature soldering:  
260 °C/ 10 seconds at terminals



17249

### Mechanical Data

**Case:** JEDEC -DO219-AB (SMF<sup>®</sup>) Plastic case

**Polarity:** Band denotes cathode end

**Weight:** approx. 0.01 g

### Packaging codes-options:

GS18 - 10 K per 13" reel (8 mm tape), 50 K/box

GS08 - 3 K per 7" reel (8 mm tape), 30 K/box

### Parts Table

| Part | Marking |
|------|---------|
| S07B | SB      |
| S07D | SD      |
| S07G | SG      |
| S07J | SJ      |
| S07M | SM      |

### Absolute Maximum Ratings

T<sub>amb</sub> = 25 °C, unless otherwise specified

| Parameter   | Test condition                        | Part | Symbol             | Value | Unit |
|---|---------------------------------------|------|--------------------|-------|------|
| Maximum repetitive peak reverse voltage                 |                                       | S07B | V <sub>RRM</sub>   | 100   | V    |
|   |                                       | S07D | V <sub>RRM</sub>   | 200   | V    |
|   |                                       | S07G | V <sub>RRM</sub>   | 400   | V    |
|   |                                       | S07J | V <sub>RRM</sub>   | 600   | V    |
|   |                                       | S07M | V <sub>RRM</sub>   | 1000  | V    |
| Maximum RMS voltage                                     |                                       | S07B | V <sub>RMS</sub>   | 70    | V    |
|   |                                       | S07D | V <sub>RMS</sub>   | 140   | V    |
|   |                                       | S07G | V <sub>RMS</sub>   | 280   | V    |
|   |                                       | S07J | V <sub>RMS</sub>   | 420   | V    |
|   |                                       | S07M | V <sub>RMS</sub>   | 700   | V    |
| Maximum DC blocking voltage                             |                                       | S07B | V <sub>DC</sub>    | 100   | V    |
|   |                                       | S07D | V <sub>DC</sub>    | 200   | V    |
|   |                                       | S07G | V <sub>DC</sub>    | 400   | V    |
|   |                                       | S07J | V <sub>DC</sub>    | 600   | V    |
|   |                                       | S07M | V <sub>DC</sub>    | 1000  | V    |
| Maximum average forward rectified current               | T <sub>tp</sub> = 75 °C <sup>1)</sup> |      | I <sub>F(AV)</sub> | 1.5   | A    |
|   | T <sub>A</sub> = 65 °C <sup>1)</sup>  |      | I <sub>F(AV)</sub> | 0.7   | A    |
| Peak forward surge current 8.3 ms single half sine-wave | T <sub>L</sub> = 25 °C                |      | I <sub>FSM</sub>   | 25    | A    |

<sup>1)</sup> Averaged over any 20 ms period

### Thermal Characteristics

$T_{amb} = 25\text{ }^{\circ}\text{C}$ , unless otherwise specified

| Parameter  | Test condition | Symbol          | Value         | Unit               |
|--|----------------|-----------------|---------------|--------------------|
| Thermal resistance junction to ambient air <sup>2)</sup> |                | $R_{\theta JA}$ | 180           | K/W                |
| Operating junction and storage temperature range         |                | $T_J, T_{STG}$  | - 55 to + 150 | $^{\circ}\text{C}$ |

<sup>2)</sup> Mounted on epoxy substrate with 3 x 3 mm CU pads ( $\geq 40\text{ }\mu\text{m}$  thick)

### Electrical Characteristics

$T_{amb} = 25\text{ }^{\circ}\text{C}$ , unless otherwise specified

| Parameter   | Test condition   | Symbol   | Min | Typ. | Max | Unit          |
|---|--|----------|-----|------|-----|---------------|
| Maximum instantaneous forward voltage                   | $1.0\text{ A}^3)$  | $V_F$    |     |      | 1.1 | V             |
| Maximum DC reverse current at rated DC blocking voltage | $T_A = 25\text{ }^{\circ}\text{C}$                               | $I_R$    |     |      | 10  | $\mu\text{A}$ |
|   | $T_A = 125\text{ }^{\circ}\text{C}$                              | $I_R$    |     |      | 50  | $\mu\text{A}$ |
| Reverse recovery time                                   | $I_F = 0.5\text{ A}, I_R = 1.0\text{ A}, I_{rr} = 0.25\text{ A}$ | $t_{rr}$ |     |      | 1.8 | $\mu\text{s}$ |
| Typical capacitance at 4 V, MHz                         |  | $C_j$    |     | 4    |     | pF            |

<sup>3)</sup> Pulse test: 300  $\mu\text{s}$  pulse width, 1 % duty cycle

### Typical Characteristics ( $T_{amb} = 25\text{ }^{\circ}\text{C}$ unless otherwise specified)

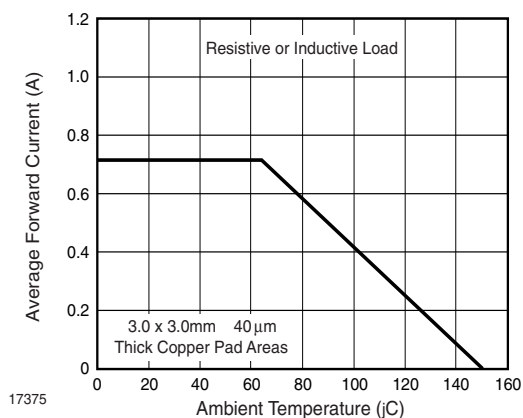

Fig. 1 Forward Current Derating Curve

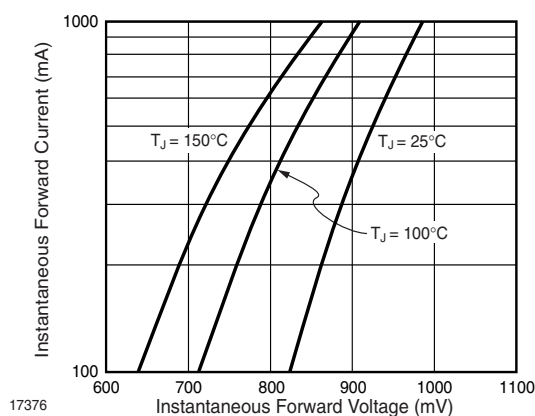

Fig. 2 Typical Instantaneous Forward Characteristics

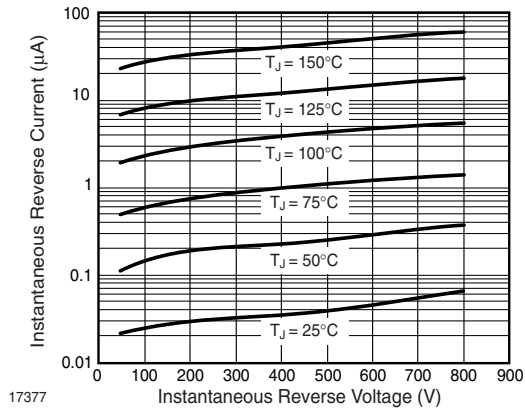

Fig. 3 Typical Instantaneous Reverse Characteristics

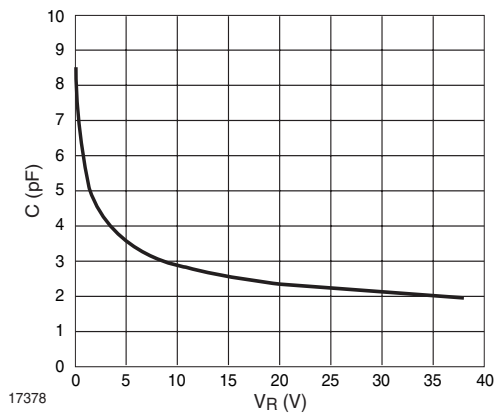
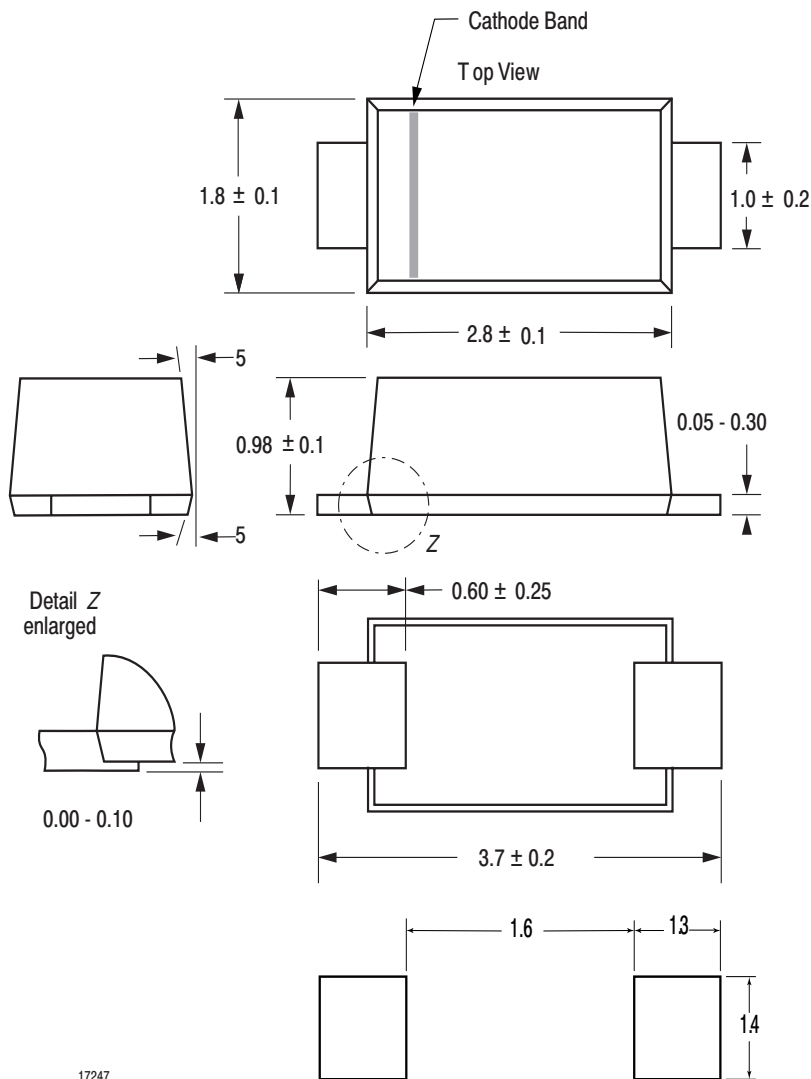
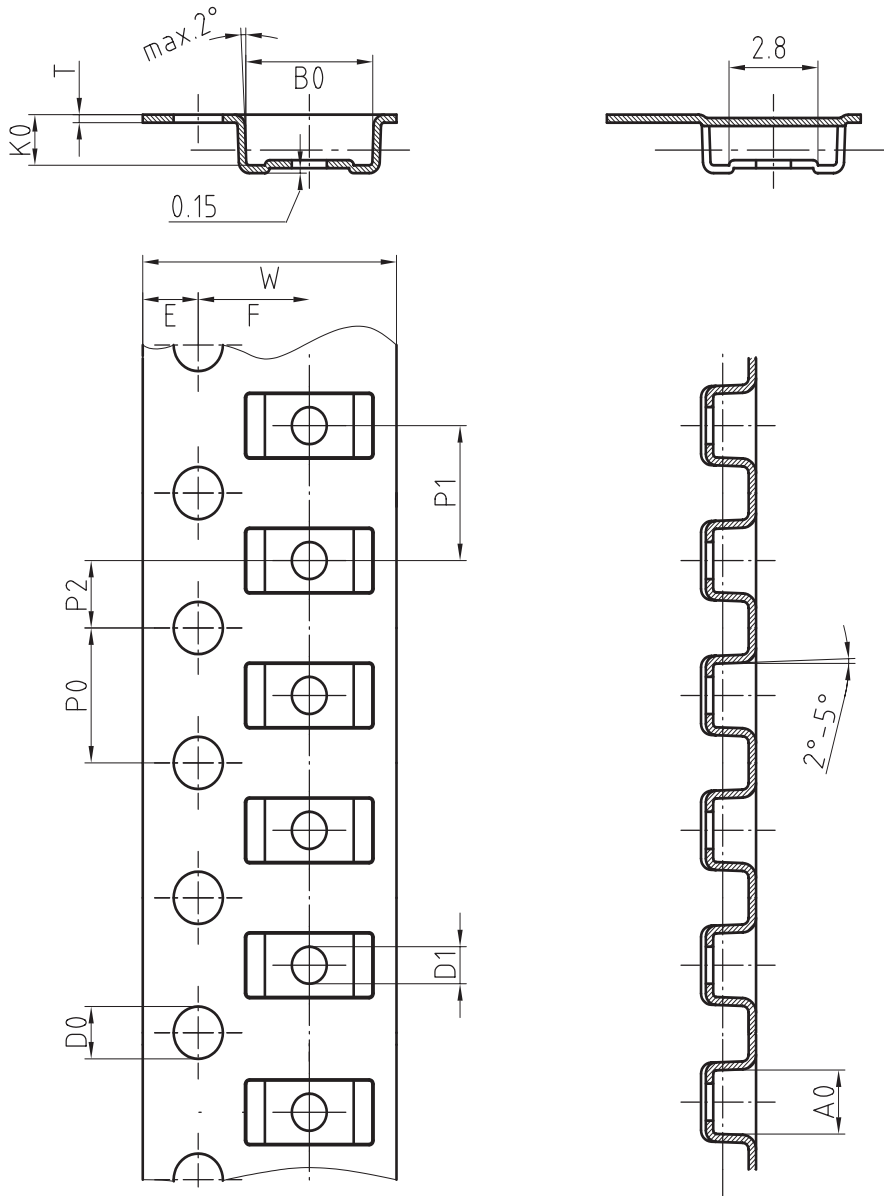

Fig. 4 Capacitance vs. Reverse Voltage

## Package Dimensions in mm



## Blistertape for SMF



| Mat: | A0  | B0  | K0  | W   | T     | P0  | P2  | P1  | D0  | D1 | E    | F   |
|------|-----|-----|-----|-----|-------|-----|-----|-----|-----|----|------|-----|
| PS   | 1.9 | 4.0 | 1.5 | 8.0 | 0.235 | 4.0 | 2.0 | 4.0 | 1.5 | 1  | 1.75 | 3.5 |

18513

### Ozone Depleting Substances Policy Statement

It is the policy of **Vishay Semiconductor GmbH** to

1. Meet all present and future national and international statutory requirements.
2. Regularly and continuously improve the performance of our products, processes, distribution and operating systems with respect to their impact on the health and safety of our employees and the public, as well as their impact on the environment.

It is particular concern to control or eliminate releases of those substances into the atmosphere which are known as ozone depleting substances (ODSs).

The Montreal Protocol (1987) and its London Amendments (1990) intend to severely restrict the use of ODSs and forbid their use within the next ten years. Various national and international initiatives are pressing for an earlier ban on these substances.

**Vishay Semiconductor GmbH** has been able to use its policy of continuous improvements to eliminate the use of ODSs listed in the following documents.

1. Annex A, B and list of transitional substances of the Montreal Protocol and the London Amendments respectively
2. Class I and II ozone depleting substances in the Clean Air Act Amendments of 1990 by the Environmental Protection Agency (EPA) in the USA
3. Council Decision 88/540/EEC and 91/690/EEC Annex A, B and C (transitional substances) respectively.

**Vishay Semiconductor GmbH** can certify that our semiconductors are not manufactured with ozone depleting substances and do not contain such substances.

**We reserve the right to make changes to improve technical design  
and may do so without further notice.**

Parameters can vary in different applications. All operating parameters must be validated for each customer application by the customer. Should the buyer use Vishay Semiconductors products for any unintended or unauthorized application, the buyer shall indemnify Vishay Semiconductors against all claims, costs, damages, and expenses, arising out of, directly or indirectly, any claim of personal damage, injury or death associated with such unintended or unauthorized use.

Vishay Semiconductor GmbH, P.O.B. 3535, D-74025 Heilbronn, Germany  
Telephone: 49 (0)7131 67 2831, Fax number: 49 (0)7131 67 2423