

# 8187

## LOW-DROPOUT, 3.3 V REGULATOR — HIGH EFFICIENCY

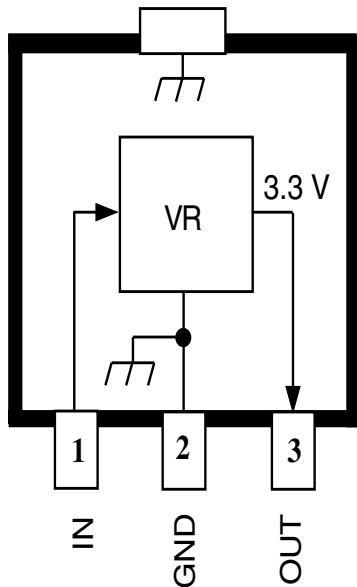

Dwg. PS-022-1

Designed specifically to meet the requirement for extended operation of battery-powered equipment such as cordless and cellular telephones, the A8187SLT voltage regulator offers the reduced dropout voltage and quiescent current essential for maximum battery life. Applicable also to palmtop computers and personal data assistants, the device delivers a regulated, continuous 3.3 V output at up to 75 mA under normal operating conditions, or to 150 mA (transient) under worst-case conditions.

A PMOS pass element provides a typical dropout voltage of only 85 mV at 60 mA of load current. The low dropout voltage permits deeper battery discharge before output regulation is lost. Furthermore, quiescent current does not increase as the dropout voltage is approached, an ideal feature in standby/resume power systems where data integrity is crucial. Regulator accuracy and excellent temperature characteristics are provided by a bandgap reference.

This device is supplied in a small-outline plastic transistor package (SOT-89/TO-243AA) for surface-mount applications. The A8187SLT is rated for operation over a temperature range of -20°C to +85°C. A similar device with an ENABLE input for control over sequential power up, standby, or power down is the A8186SLU.

### ABSOLUTE MAXIMUM RATINGS

Input Voltage, $V_I$ .....	10 V
Output Current, $I_O$ .....	150 mA*
Operating Temperature Range, $T_A$ .....	-20°C to +85°C
Junction Temperature, $T_J$ ...	+150°C†
Storage Temperature Range, $T_S$ .....	-40°C to +150°C

\* Output current rating is limited by input voltage, duty cycle, and ambient temperature. Under any set of conditions, do not exceed a junction temperature of +150°C. See next page.

† Fault conditions that produce excessive junction temperature will activate device thermal shutdown circuitry. These conditions can be tolerated but should be avoided.

### FEATURES AND BENEFITS

- High Efficiency Provides Extended Battery Life
- 85 mV Typical Dropout Voltage at  $I_O = 60$  mA
- 45  $\mu$ A Typical Quiescent Current at  $V_I = 6$  V
- Up to 150 mA Output Current
- Internal Thermal Protection
- Surface-Mount Package

### APPLICATIONS

- Cordless and Cellular Telephones
- Personal Data Assistants
- Personal Communicators
- Palmtop Computers

Always order by complete part number: **A8187SLT**

# 8187 LOW-DROPOUT, 3.3 V REGULATOR

## FUNCTIONAL BLOCK DIAGRAM

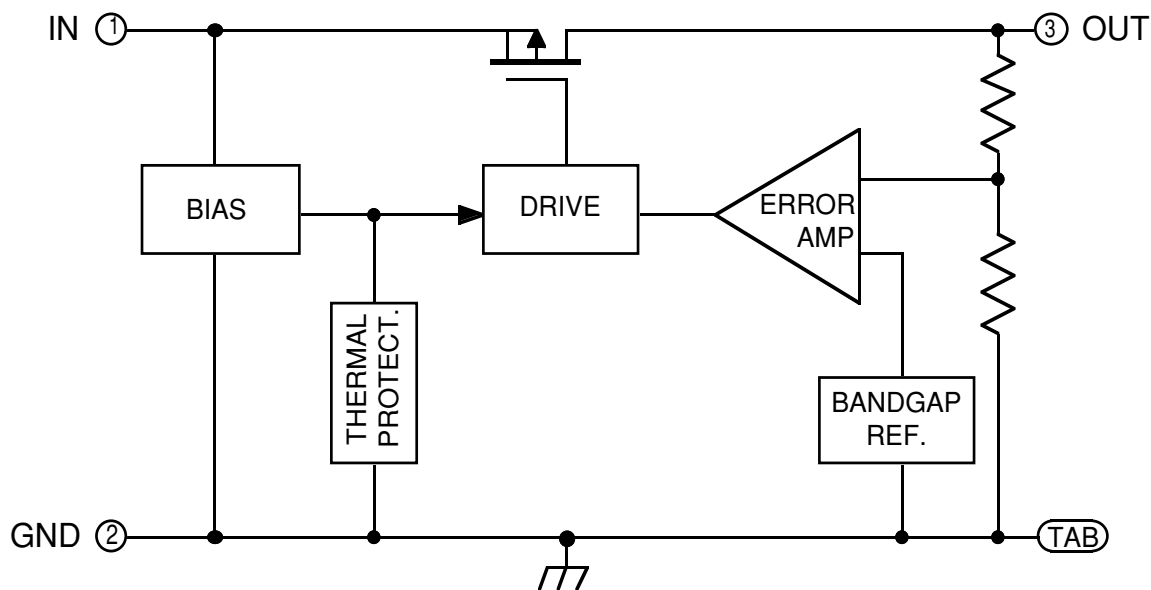

Dwg. FS-012-4

### MAXIMUM ALLOWABLE OUTPUT CURRENT with device mounted on 2.24" x 2.24" (56.9 mm x 56.9 mm) solder-coated copper-clad board in still air.

T <sub>A</sub>	Maximum Allowable Output Current in Milliamperes with V <sub>I</sub> = 8 V, T <sub>J</sub> = 150°C, Period ≤ 10 s*								
	dc (Duty Cycle)								
	100%	90%	80%	70%	60%	50%	40%	30%	20%
25°C	100	115	125	145	150	150	150	150	150
50°C	80	90	100	115	135	150	150	150	150
70°C	65	70	80	90	110	130	150	150	150
85°C	50	60	65	75	85	105	130	150	150

$$* I_O = (T_J - T_A) / ([V_I - V_O] R_{\theta JA} \cdot dc) = (150 - T_A) / (4.7 \cdot 258 \cdot dc)$$

Output current rating can be increased (to 150 mA maximum) by heat sinking or reducing the input voltage. Conditions that produce excessive junction temperature will activate device thermal shutdown circuitry. These conditions can be tolerated but should be avoided.



115 Northeast Cutoff, Box 15036  
Worcester, Massachusetts 01615-0036 (508) 853-5000  
Copyright © 1995, 2000 Allegro MicroSystems, Inc.

**8187**  
**LOW-DROPOUT,**  
**3.3 V REGULATOR**

**ELECTRICAL CHARACTERISTICS at  $T_A = +25^\circ\text{C}$  (unless otherwise noted).**

Characteristic	Symbol	Test Conditions	Limits				
			Min.	Typ.	Max.	Units	
Output Voltage	$V_O$	$4\text{ V} \leq V_I \leq 8\text{ V}$ , $10\ \mu\text{A} \leq I_O \leq 100\ \text{mA}^*$	$T_A = +25^\circ\text{C}$	3.25	3.30	3.35	V
			$-20^\circ\text{C} \leq T_A \leq +85^\circ\text{C}$	3.20	3.30	3.40	V
		$V_I = 3.3\text{ V}$ , $I_O = 60\ \text{mA}^*$ , $-20^\circ\text{C} \leq T_A \leq +85^\circ\text{C}$	3.00	—	—	V	
Output Volt. Temp. Coeff.	$\alpha_{V_O}$	$V_I = 6\text{ V}$ , $I_O = 10\ \text{mA}$	—	—	$\pm 1.0$	mV/ $^\circ\text{C}$	
Line Regulation	$\Delta V_{O(\Delta V_I)}$	$6\text{ V} \leq V_I \leq 8\text{ V}$ , $I_O = 1\ \text{mA}$	—	8.0	12	mV	
		$4\text{ V} \leq V_I \leq 6\text{ V}$ , $I_O = 1\ \text{mA}$	—	10	20	mV	
Load Regulation	$\Delta V_{O(\Delta I_O)}$	$1\ \text{mA} \leq I_O \leq 100\ \text{mA}^*$ , $V_I = 8\text{ V}$	—	20	30	mV	
		$1\ \text{mA} \leq I_O \leq 100\ \text{mA}^*$ , $V_I = 6\text{ V}$	—	13	25	mV	
		$1\ \text{mA} \leq I_O \leq 100\ \text{mA}^*$ , $V_I = 4\text{ V}$	—	8.0	20	mV	
Dropout Voltage	$V_{I,\text{min}} - V_O$	$I_O = 60\ \text{mA}^*$	—	85	150	mV	
		$I_O = 125\ \text{mA}^*$	—	190	300	mV	
Quiescent Current (GND terminal current)	$I_Q$	$V_I = 6\text{ V}$ , $1\ \text{mA} \leq I_O \leq 100\ \text{mA}^*$	—	45	60	$\mu\text{A}$	
		$V_I = 8\text{ V}$ , $1\ \text{mA} \leq I_O \leq 100\ \text{mA}^*$	—	50	65	$\mu\text{A}$	
Thermal Shutdown Temp.	$T_J$		150	—	—	$^\circ\text{C}$	
Thermal Resistance	$R_{\theta JA}$	Mounted on 2.24" x 2.24" solder-coated copper-clad board in still air	—	258	—	$^\circ\text{C}/\text{W}$	

Typical values are at  $T_A = +25^\circ\text{C}$  and are given for circuit design information only.

\* Pulse test ( $\leq 20\ \text{ms}$ ). See previous page for duty cycle limitations.

# 8187 LOW-DROPOUT, 3.3 V REGULATOR

## TYPICAL CHARACTERISTICS

### LOAD REGULATION

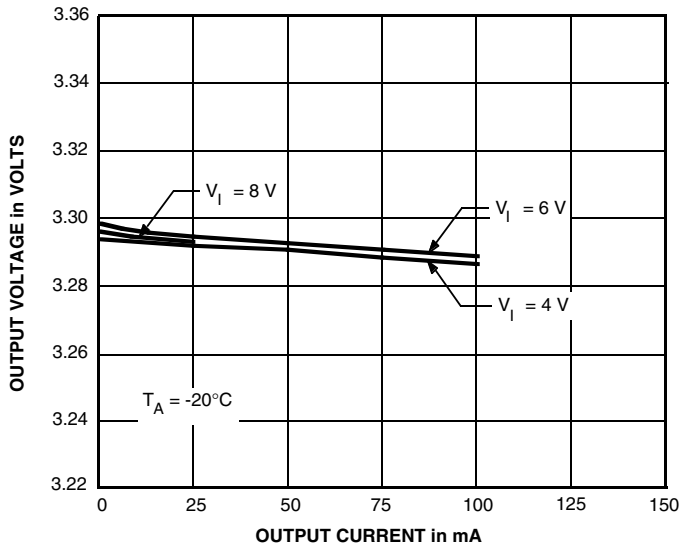

Dwg. GP-052-6

### LINE REGULATION

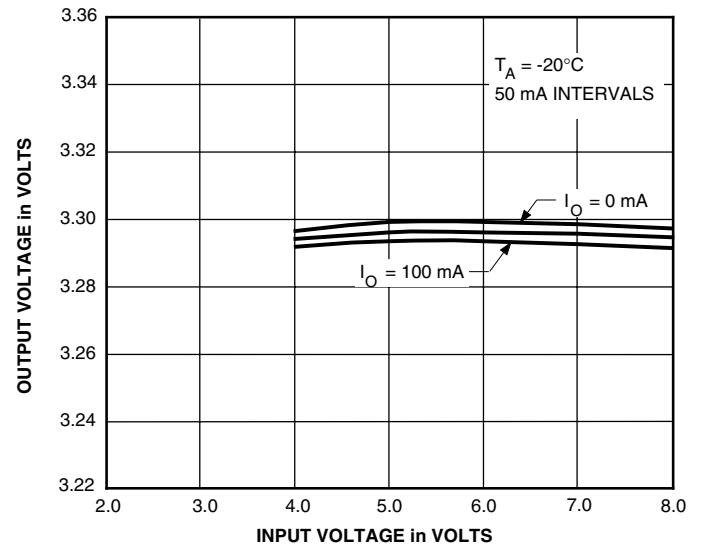

Dwg. GP-053-6

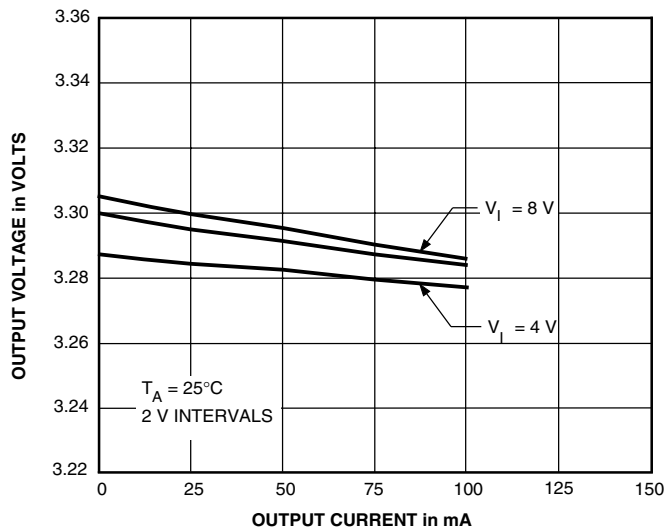

Dwg. GP-052-7

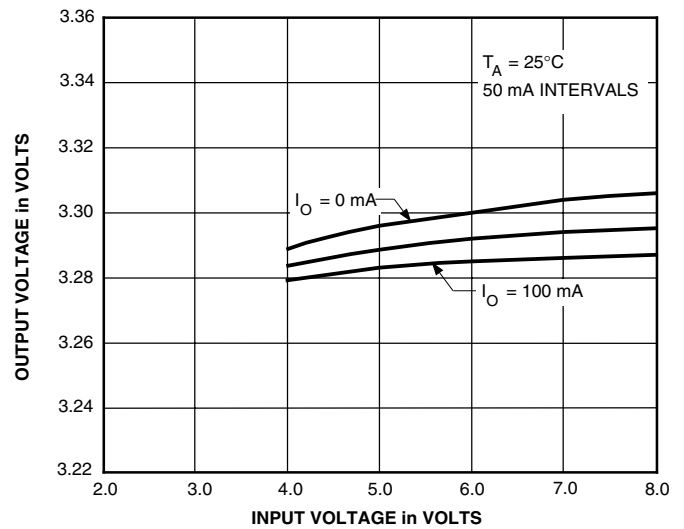

Dwg. GP-053-7

**CAUTION:** Maximum allowable duty cycle will be significantly less than 100% at high temperatures, at high input voltages, or at high output currents. See Maximum Allowable Output Current table.



115 Northeast Cutoff, Box 15036  
Worcester, Massachusetts 01615-0036 (508) 853-5000

# 8187 LOW-DROPOUT, 3.3 V REGULATOR

## TYPICAL CHARACTERISTICS (cont'd)

### LOAD REGULATION

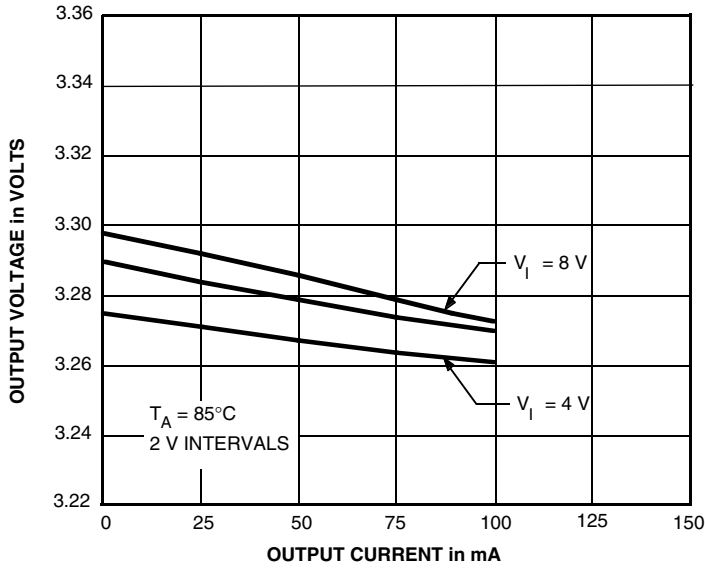

Dwg. GP-052-8

### LINE REGULATION

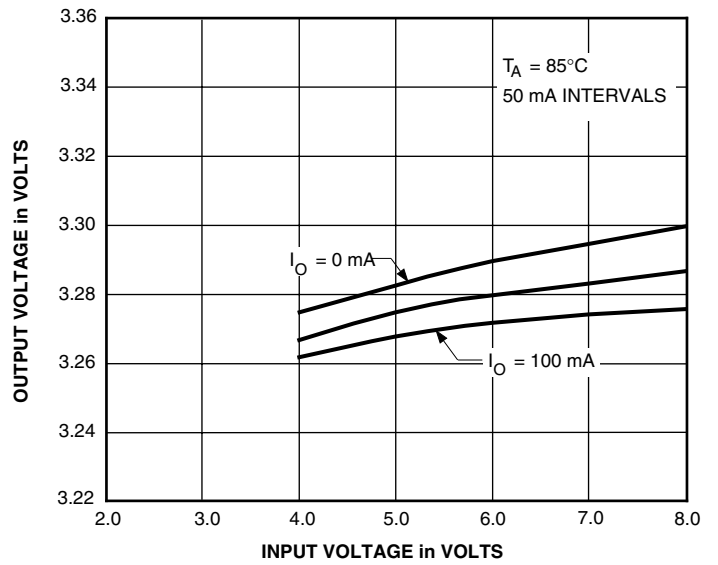

Dwg. GP-053-8

## OUTPUT VOLTAGE

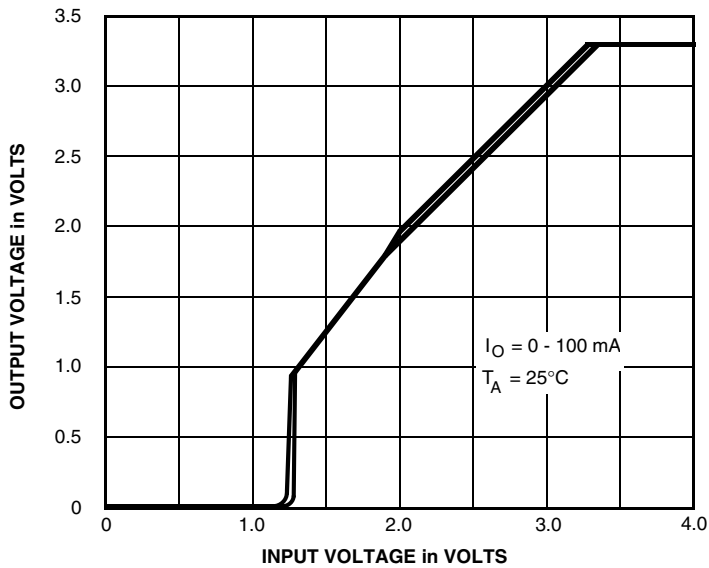

Dwg. GP-059-1

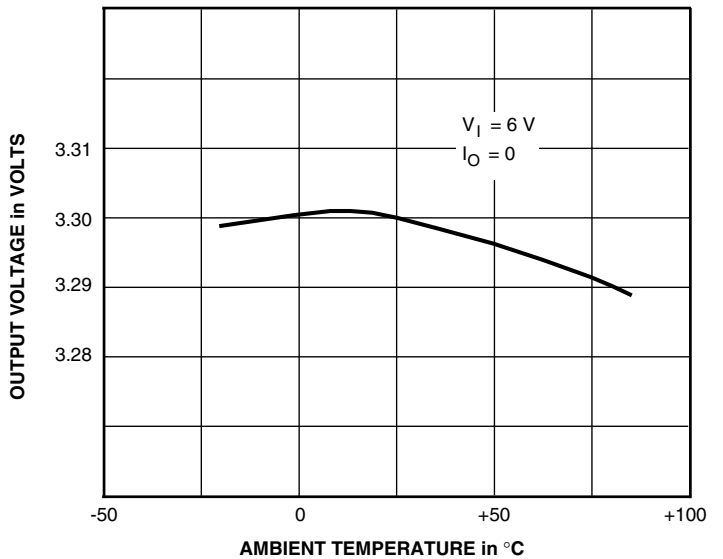

Dwg. GP-050-2

**CAUTION:** Maximum allowable duty cycle will be significantly less than 100% at high temperatures, at high input voltages, or at high output currents. See Maximum Allowable Output Current table.

# 8187 LOW-DROPOUT, 3.3 V REGULATOR

## TYPICAL CHARACTERISTICS (concluded)

### QUIESCENT (GROUND TERMINAL) CURRENT

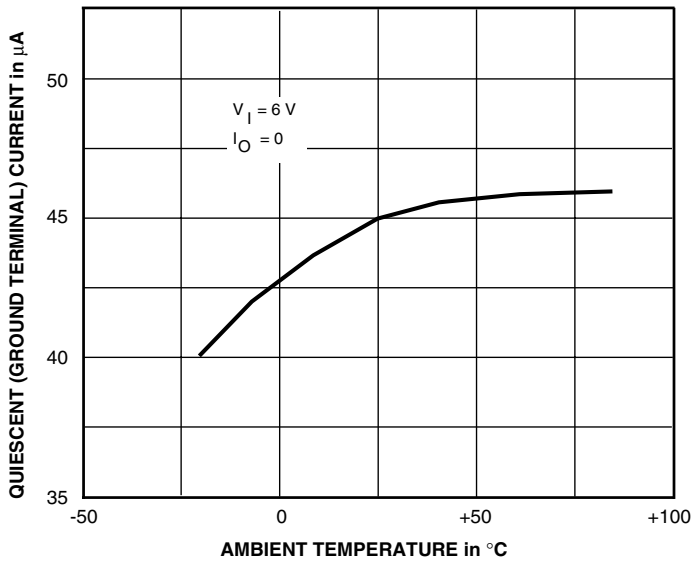

Dwg. GP-051-2

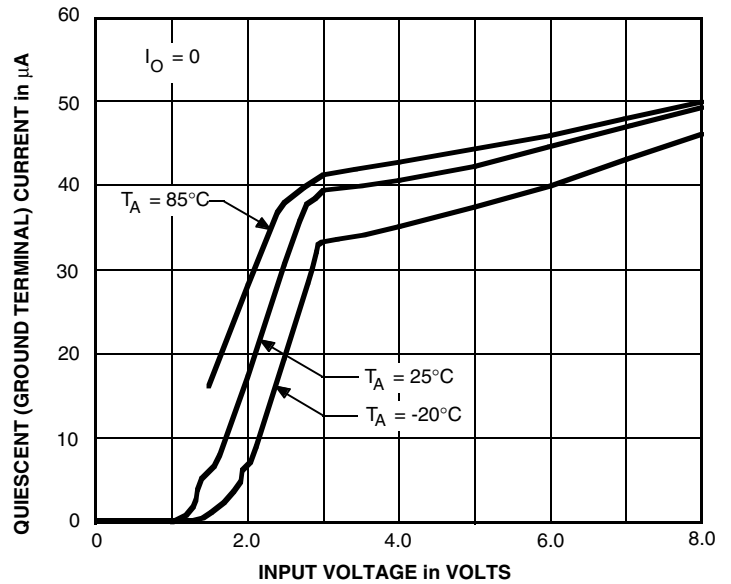

Dwg. GP-058

### DROPOUT VOLTAGE

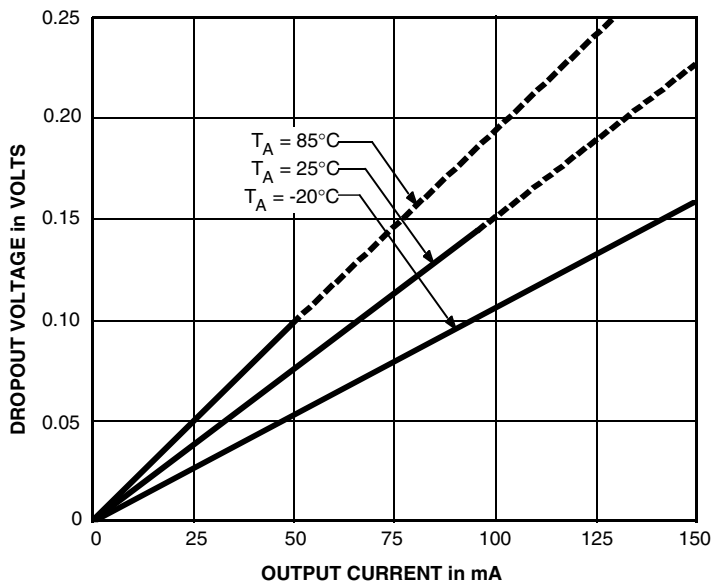

Dwg. GP-054-1

### LOAD TRANSIENT PERFORMANCE

$V_I = 3.5\text{ V to }6.5\text{ V}$ ,  $C_O$  as specified,  $T_A = 25^{\circ}\text{C}$

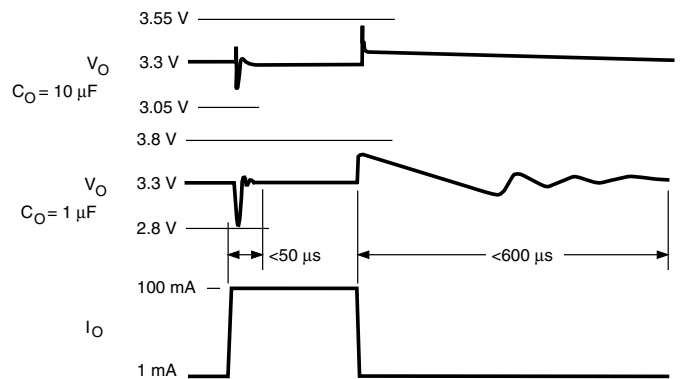

Dwg. WP-028-1

**CAUTION:** Maximum allowable duty cycle will be significantly less than 100% at high temperatures, at high input voltages, or at high output currents. See Maximum Allowable Output Current table.



115 Northeast Cutoff, Box 15036  
Worcester, Massachusetts 01615-0036 (508) 853-5000

# 8187 LOW-DROPOUT, 3.3 V REGULATOR

## Dimensions in Inches (for reference only)

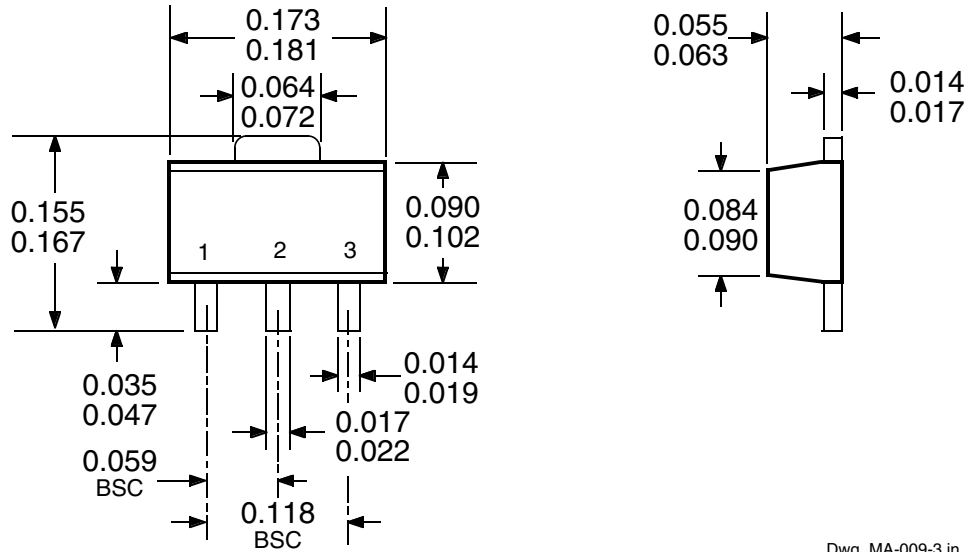

Dwg. MA-009-3 in

## Dimensions in Millimeters (controlling dimensions)

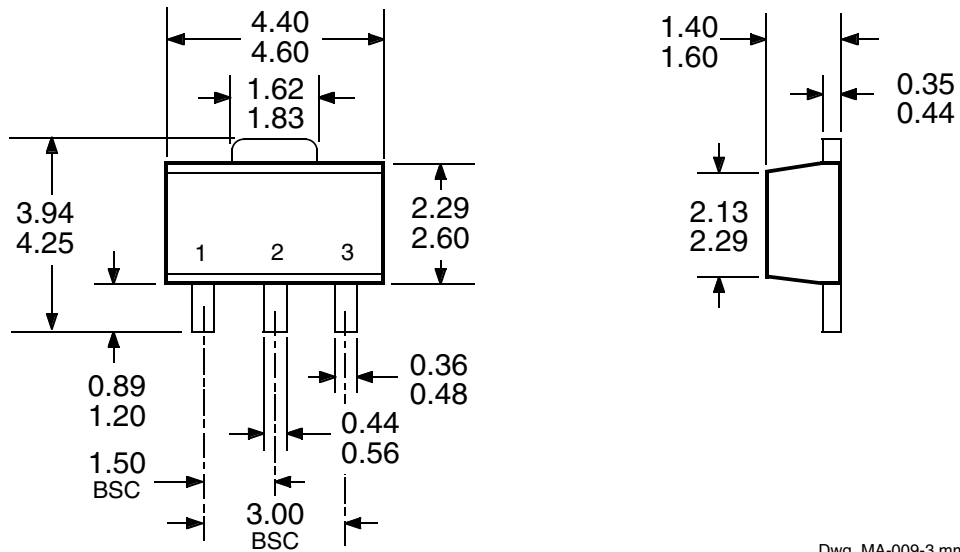

Dwg. MA-009-3 mm

- NOTES: 1. Lead spacing tolerance is non-cumulative.  
2. Exact body and lead configuration at vendor's option within limits shown.

**8187**  
***LOW-DROPOUT,***  
***3.3 V REGULATOR***

*Allegro MicroSystems, Inc. reserves the right to make, from time to time, such departures from the detail specifications as may be required to permit improvements in the design of its products.*

*The information included herein is believed to be accurate and reliable. However, Allegro MicroSystems, Inc. assumes no responsibility for its use; nor for any infringements of patents or other rights of third parties which may result from its use.*



115 Northeast Cutoff, Box 15036  
Worcester, Massachusetts 01615-0036 (508) 853-5000