

## SIPMOS® Small-Signal Transistor

- P channel
- Enhancement mode
- Logic Level
- $V_{GS(th)} = -0.8...-2.0$  V

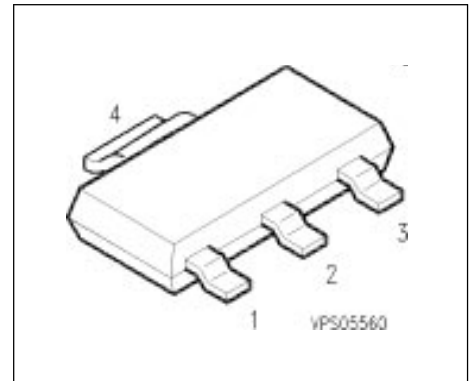

Pin 1	Pin 2	Pin 3	Pin 4
G	D	S	D

Type	$V_{DS}$	$I_D$	$R_{DS(on)}$	Package	Marking
BSP 316	-100 V	-0.65 A	2.2 $\Omega$	SOT-223	BSP 316

Type	Ordering Code	Tape and Reel Information
BSP 316	Q67000-S92	E6327

### Maximum Ratings

Parameter	Symbol	Values	Unit
Drain source voltage	$V_{DS}$	-100	V
Drain-gate voltage $R_{GS} = 20$ k $\Omega$	$V_{DGR}$	-100	
Gate source voltage	$V_{GS}$	$\pm 20$	
Continuous drain current $T_A = 24$ °C	$I_D$	-0.65	A
DC drain current, pulsed $T_A = 25$ °C	$I_{Dpuls}$	-2.6	
Power dissipation $T_A = 25$ °C	$P_{tot}$	1.8	W

## Maximum Ratings

Parameter	Symbol	Values	Unit
Chip or operating temperature	$T_j$	-55 ... + 150	°C
Storage temperature	$T_{stg}$	-55 ... + 150	
Thermal resistance, chip to ambient air	$R_{thJA}$	≤ 70	K/W
Thermal resistance, junction-soldering point <sup>1)</sup>	$R_{thJS}$	≤ 10	
DIN humidity category, DIN 40 040		E	
IEC climatic category, DIN IEC 68-1		55 / 150 / 56	

1) Transistor on epoxy pcb 40 mm x 40 mm x 1,5 mm with 6 cm<sup>2</sup> copper area for drain connection

## Electrical Characteristics, at $T_j = 25^\circ\text{C}$ , unless otherwise specified

Parameter	Symbol	Values			Unit
		min.	typ.	max.	

### Static Characteristics

Drain- source breakdown voltage $V_{GS} = 0 \text{ V}, I_D = -0.25 \text{ mA}, T_j = 25 \text{ }^\circ\text{C}$	$V_{(BR)DSS}$	-100	-	-	V
Gate threshold voltage $V_{GS} = V_{DS}, I_D = -1 \text{ mA}$	$V_{GS(th)}$	-0.8	-1.1	-2	
Zero gate voltage drain current $V_{DS} = -100 \text{ V}, V_{GS} = 0 \text{ V}, T_j = 25 \text{ }^\circ\text{C}$ $V_{DS} = -100 \text{ V}, V_{GS} = 0 \text{ V}, T_j = 125 \text{ }^\circ\text{C}$ $V_{DS} = -60 \text{ V}, V_{GS} = 0 \text{ V}, T_j = 25 \text{ }^\circ\text{C}$	$I_{DSS}$	-	-0.1 -10 -	-1 -100 -100	$\mu\text{A}$  nA
Gate-source leakage current $V_{GS} = -20 \text{ V}, V_{DS} = 0 \text{ V}$	$I_{GSS}$	-	-10	-100	nA
Drain-Source on-state resistance $V_{GS} = -10 \text{ V}, I_D = -0.65 \text{ A}$	$R_{DS(on)}$	-	1.4	2.2	$\Omega$

## Electrical Characteristics, at $T_j = 25^\circ\text{C}$ , unless otherwise specified

Parameter	Symbol	Values			Unit
		min.	typ.	max.	

### Dynamic Characteristics

Transconductance $V_{DS} \geq 2 * I_D * R_{DS(on)max}$ , $I_D = -0.65 \text{ A}$	$g_{fs}$	0.25	0.45	-	S
Input capacitance $V_{GS} = 0 \text{ V}$ , $V_{DS} = 25 \text{ V}$ , $f = 1 \text{ MHz}$	$C_{iss}$	-	280	370	pF
Output capacitance $V_{GS} = 0 \text{ V}$ , $V_{DS} = 25 \text{ V}$ , $f = 1 \text{ MHz}$	$C_{oss}$	-	75	110	
Reverse transfer capacitance $V_{GS} = 0 \text{ V}$ , $V_{DS} = 25 \text{ V}$ , $f = 1 \text{ MHz}$	$C_{rss}$	-	25	40	
Turn-on delay time $V_{DD} = -30 \text{ V}$ , $V_{GS} = -10 \text{ V}$ , $I_D = -0.29 \text{ A}$ $R_{GS} = 50 \Omega$	$t_{d(on)}$	-	8	12	ns
Rise time $V_{DD} = -30 \text{ V}$ , $V_{GS} = -10 \text{ V}$ , $I_D = -0.29 \text{ A}$ $R_{GS} = 50 \Omega$	$t_r$	-	30	45	
Turn-off delay time $V_{DD} = -30 \text{ V}$ , $V_{GS} = -10 \text{ V}$ , $I_D = -0.29 \text{ A}$ $R_{GS} = 50 \Omega$	$t_{d(off)}$	-	80	110	
Fall time $V_{DD} = -30 \text{ V}$ , $V_{GS} = -10 \text{ V}$ , $I_D = -0.29 \text{ A}$ $R_{GS} = 50 \Omega$	$t_f$	-	95	130	

**Electrical Characteristics, at  $T_j = 25^\circ\text{C}$ , unless otherwise specified**

Parameter	Symbol	Values			Unit
		min.	typ.	max.	

**Reverse Diode**

Inverse diode continuous forward current $T_A = 25^\circ\text{C}$	$I_S$	-	-	-0.65	A
Inverse diode direct current, pulsed $T_A = 25^\circ\text{C}$	$I_{SM}$	-	-	-2.6	
Inverse diode forward voltage $V_{GS} = 0\text{ V}, I_F = -1.3\text{ A}, T_j = 25^\circ\text{C}$	$V_{SD}$	-	-1	-1.3	V

### Power dissipation

$$P_{\text{tot}} = f(T_A)$$

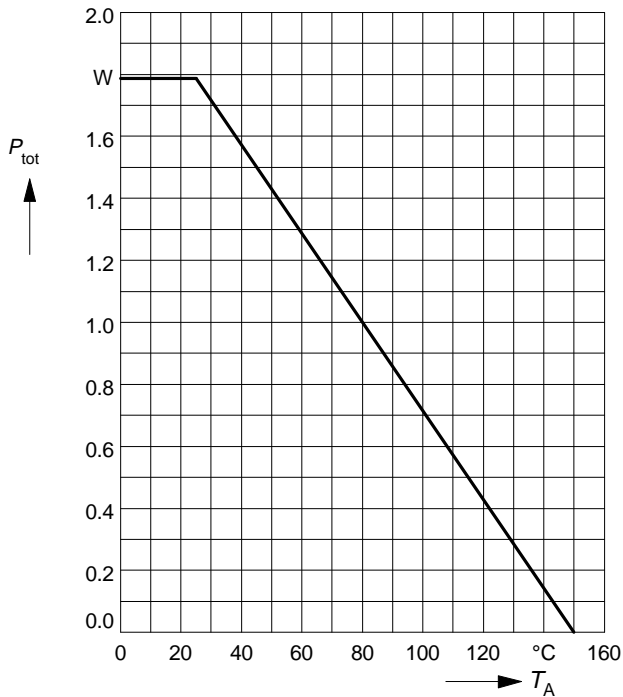

### Drain current

$$I_D = f(T_A)$$

parameter:  $V_{GS} \geq -10 \text{ V}$

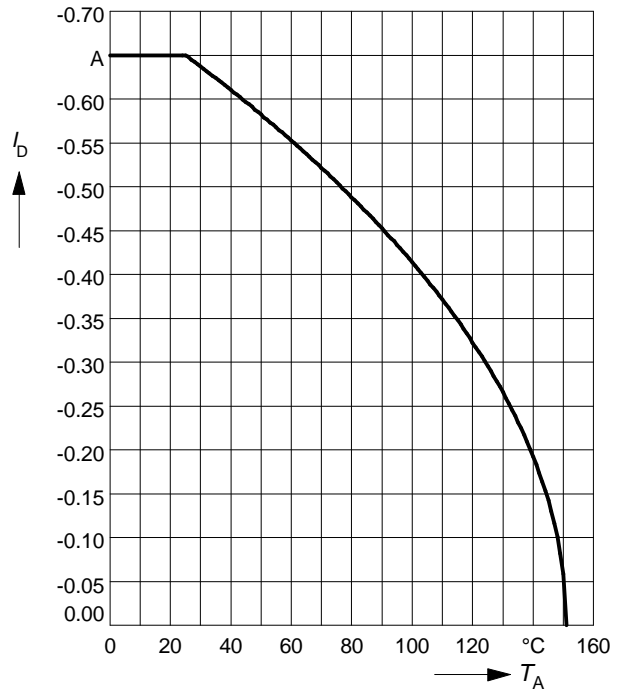

### Safe operating area $I_D = f(V_{DS})$

parameter:  $D = 0, T_C = 25^\circ\text{C}$

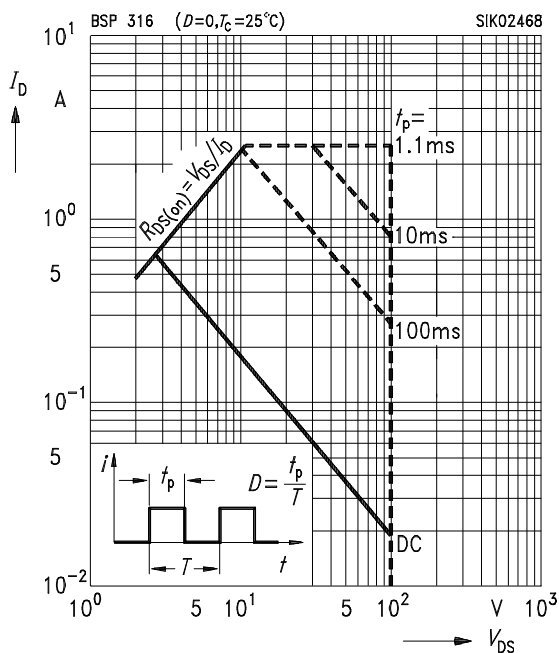

### Transient thermal impedance

$$Z_{\text{thJA}} = f(t_p)$$

parameter:  $D = t_p / T$

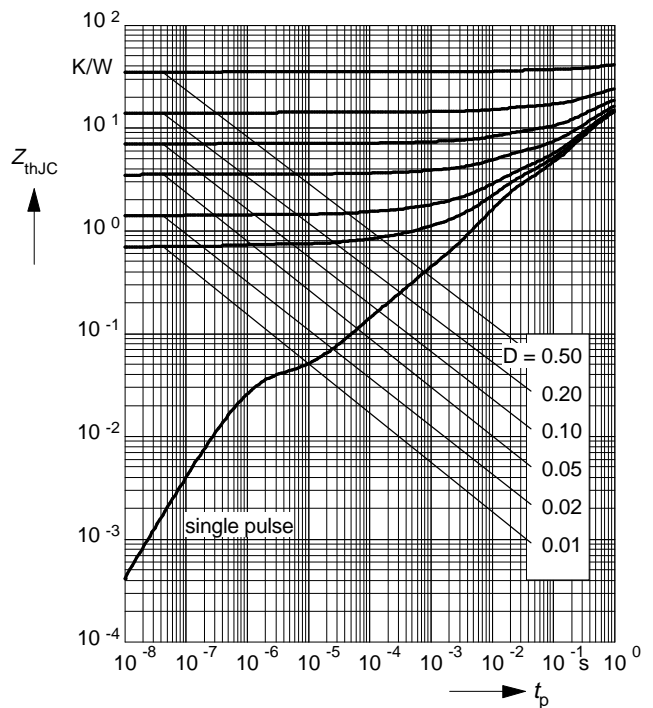

### Typ. output characteristics

$$I_D = f(V_{DS})$$

parameter:  $t_p = 80 \mu s$

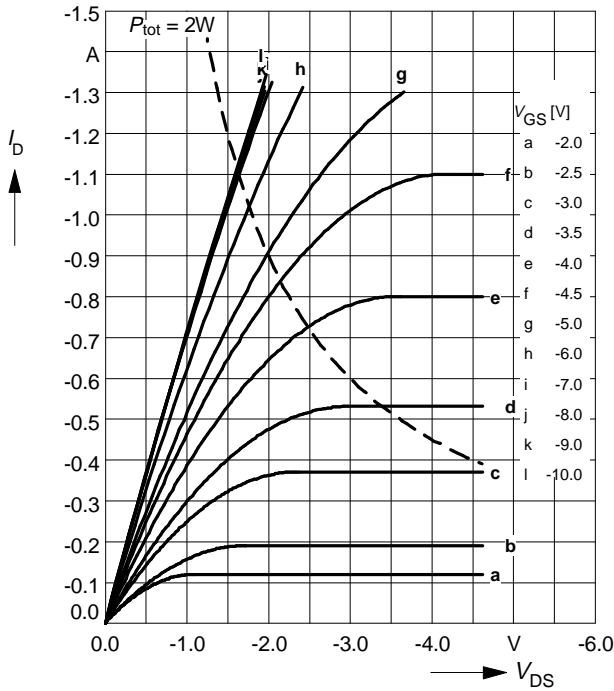

### Typ. drain-source on-resistance

$$R_{DS(on)} = f(I_D)$$

parameter:  $t_p = 80 \mu s, T_j = 25^\circ C$

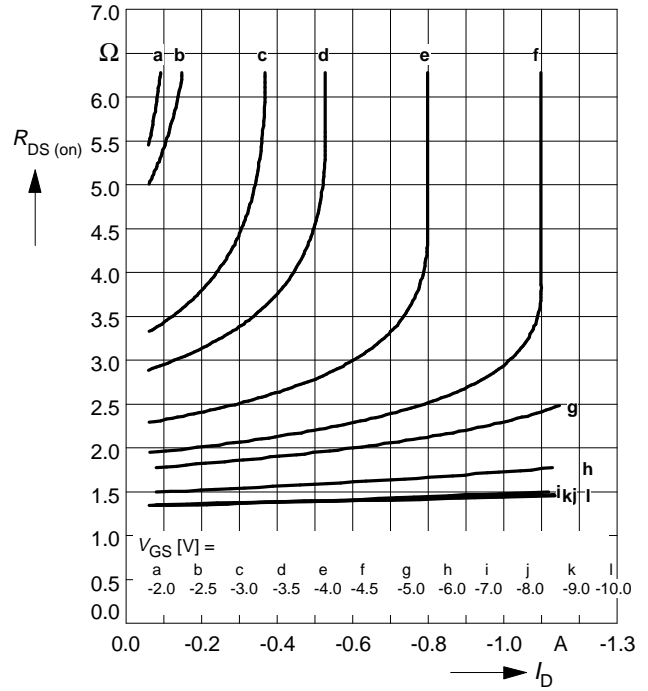

### Typ. transfer characteristics $I_D = f(V_{GS})$

parameter:  $t_p = 80 \mu s$

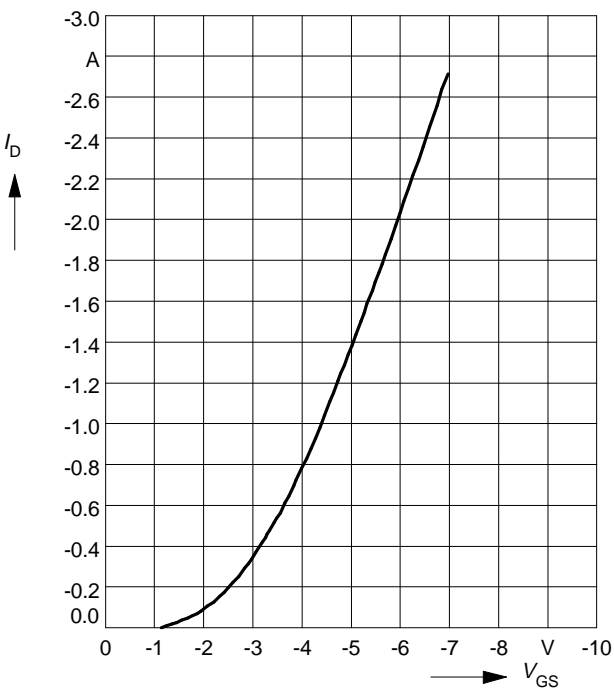

### Typ. forward transconductance $g_{fs} = f(I_D)$

parameter:  $t_p = 80 \mu s$

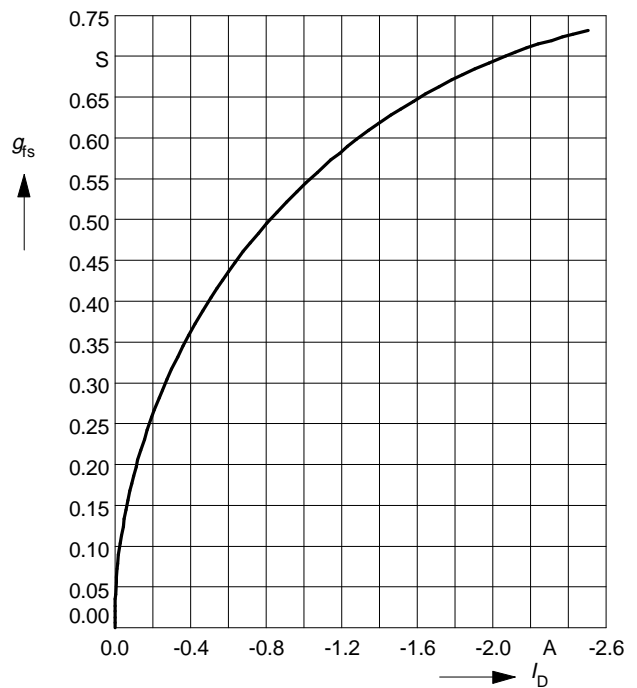

### Drain-source on-resistance

$$R_{DS(on)} = f(T_j)$$

parameter:  $I_D = -0.65 \text{ A}$ ,  $V_{GS} = -10 \text{ V}$

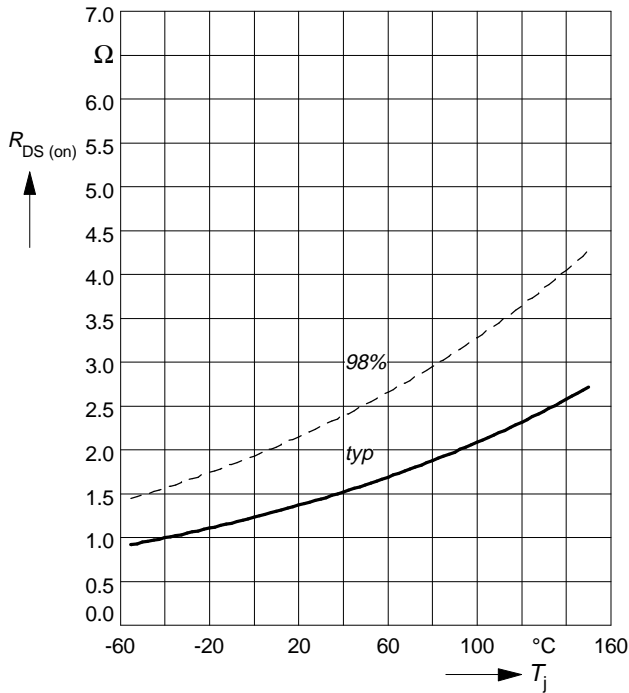

### Gate threshold voltage

$$V_{GS(th)} = f(T_j)$$

parameter:  $V_{GS} = V_{DS}$ ,  $I_D = -1 \text{ mA}$

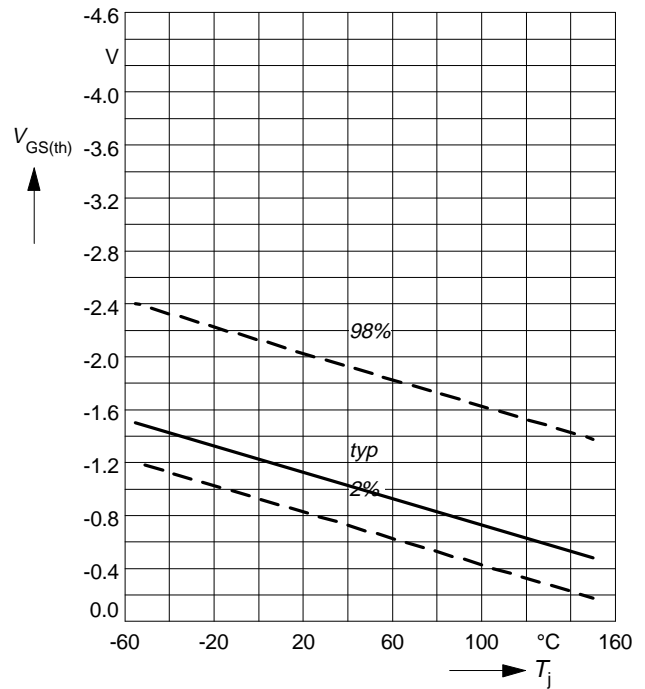

### Typ. capacitances

$$C = f(V_{DS})$$

parameter:  $V_{GS}=0\text{V}$ ,  $f = 1 \text{ MHz}$

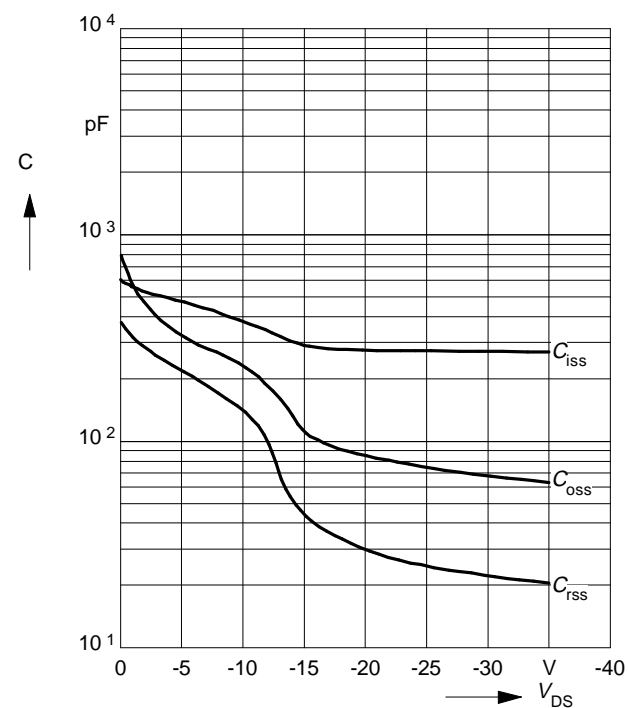

### Forward characteristics of reverse diode

$$I_F = f(V_{SD})$$

parameter:  $T_j$ ,  $t_p = 80 \mu\text{s}$

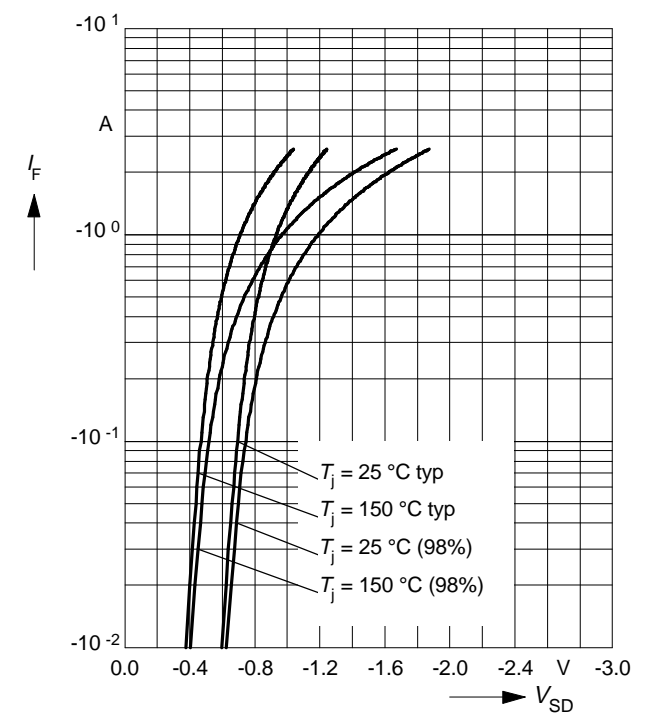

### Drain-source breakdown voltage

$$V_{(BR)DSS} = f(T_j)$$

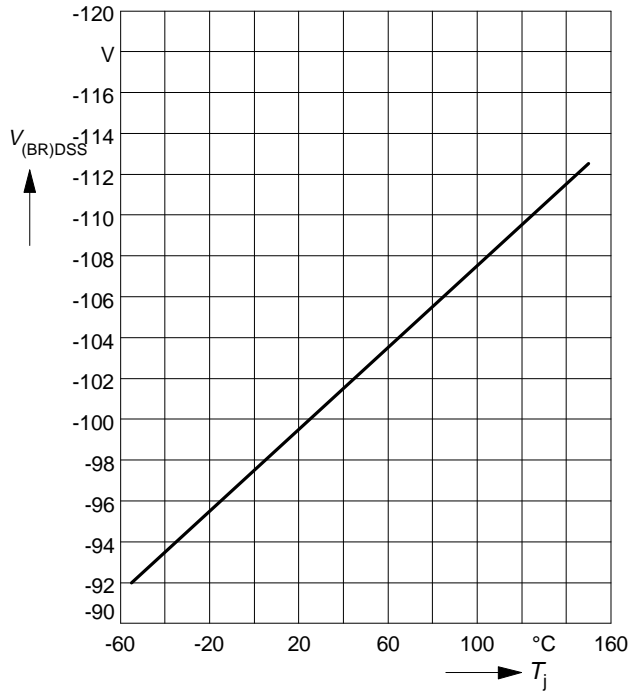

### Safe operating area $I_D = f(V_{DS})$

parameter :  $D = 0.01$ ,  $T_C = 25^\circ\text{C}$

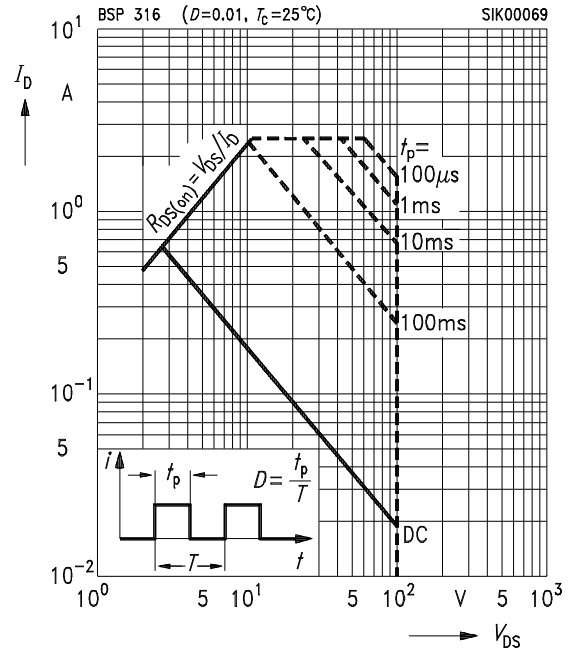



## Package outlines

SOT-223

Dimensions in mm

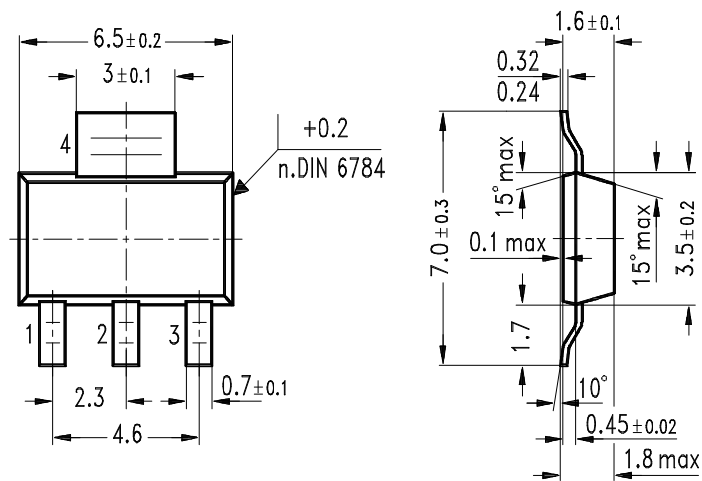

GPS05560