

SINGLE COMPARATOR

■ GENERAL DESCRIPTION

The NJM2406F is a single comparator of ultra miniature surface mount package.

The NJM2406F is suitable for small electronic equipments and hybrid circuits.

■ PACKAGE OUTLINE

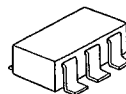

NJM2406F

■ FEATURES

- Operating Voltage (2.5V~7V)
- Single Supply Operation
- Mounted in Ultra Miniature Package 2.9×1.5mm (1/5 of DMP-8 package)
- Ground Shield Plate between + Input and Output
- Ground Shield Plate between + Input and - Input
- Suitable Pin Arrangement for Application
- Package Outline MTP5
- Bipolar Technology

■ PIN CONFIGURATION

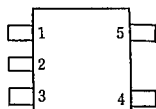

NJM2406F

PIN FUNCTION

1. -INPUT
2. GND
3. +INPUT
4. OUTPUT
5. V+

■ EQUIVALENT CIRCUIT

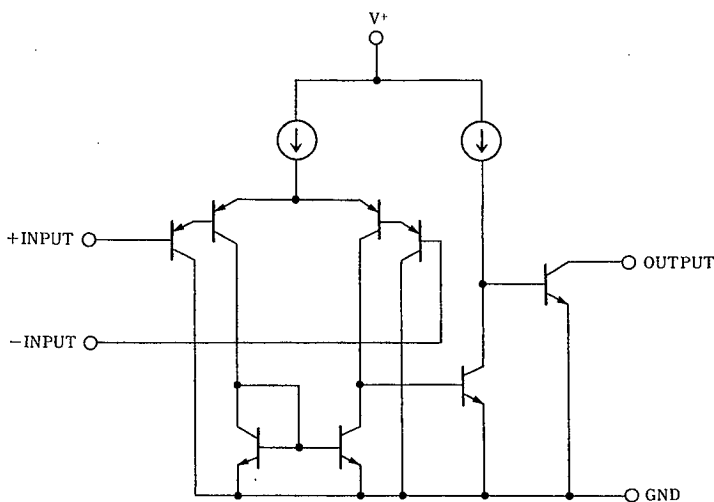

5

■ ABSOLUTE MAXIMUM RATINGS

(Ta=25°C)

PARAMETER	SYMBOL	RATINGS	UNIT
Supply Voltage	V*	7	V
Differential Input Voltage	V _{ID}	7	V
Input Voltage	V _{IN}	-0.3 to 7	V
Power Dissipation	P _D	200	mW
Output to Negative Supply Voltage	V _{SUS}	20	V
Operating Temperature Range	T _{OPR}	-40~+85	°C
Storage Temperature Range	T _{STG}	-40~+125	°C

■ ELECTRICAL CHARACTERISTICS

(V*=5V, Ta=25°C)

PARAMETER	SYMBOL	TEST CONDITION	MIN.	TYP.	MAX.	UNIT
Input Offset Voltage	V _{IO}	R _S = 0Ω, V _O = 1.4V	—	1	7	mV
Input Offset Current	I _{IO}		—	1	50	nA
Input Bias Current	I _B		—	20	250	nA
Input Common Mode Voltage Range	V _{ICM}		0~3.5	—	—	V
Large Signal Voltage Gain	A _V	R _L = 15kΩ	—	106	—	dB
Response Time	t _r	R _L = 5.1kΩ	—	1.5	—	μs
Output Sink Current	I _{SINK}	V _{IN} ⁻ = 1V, V _{IN} ⁺ = 0V, V _O = 1.5V	6	—	—	mA
Output Saturation Voltage	V _{SAT}	V _{IN} ⁻ = 1V, V _{IN} ⁺ = 0V, I _{SINK} = 5mA	—	300	500	mV
Output Leakage Current	I _{LEAK}	V _{IN} ⁻ = 0V, V _{IN} ⁺ = 1V, V _O = 20V	—	—	1	μA
Operating Current	I _{CC}		200	400	800	μA



TYPICAL CHARACTERISTICS

Input Bias Current vs. Temperature
($V^+ = 5\text{ V}$)

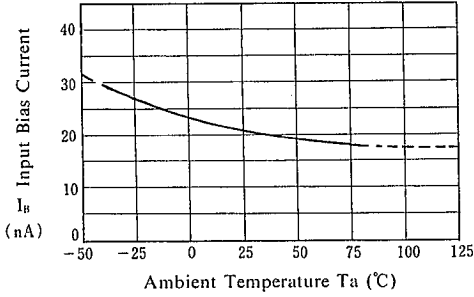

Input Offset Voltage vs. Temperature
($V^+ = 5\text{ V}$)

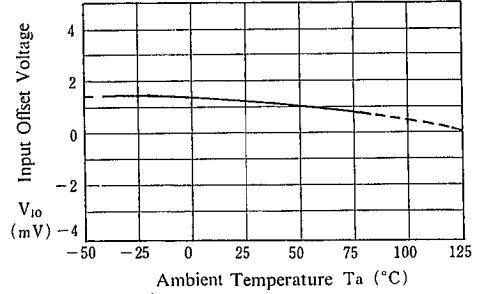

Operating Current vs. Operating Voltage
($T_a = 25^\circ\text{C}$)

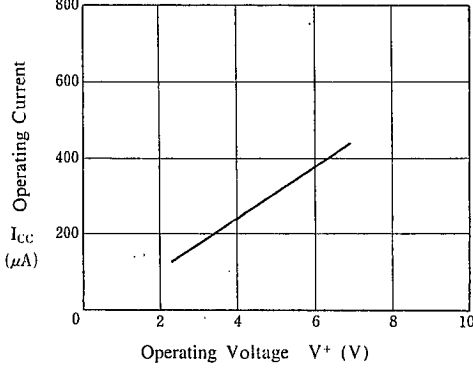

Input Bias Current vs. Operating Voltage
($T_a = 25^\circ\text{C}$)

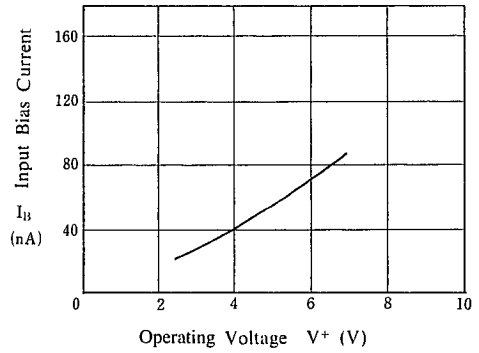

Output Saturation Voltage vs. Output Sink Current
($V^+ = 5\text{ V}$)

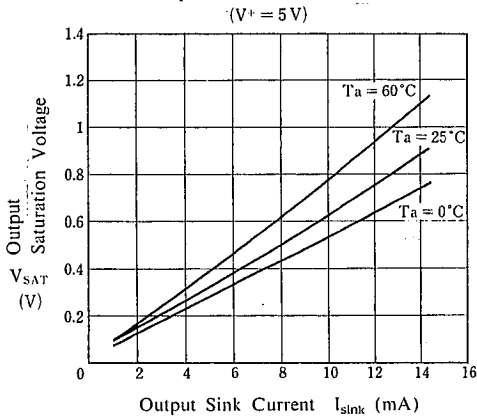

Output Saturation Voltage vs. Operating Voltage
($T_a = 25^\circ\text{C}$)

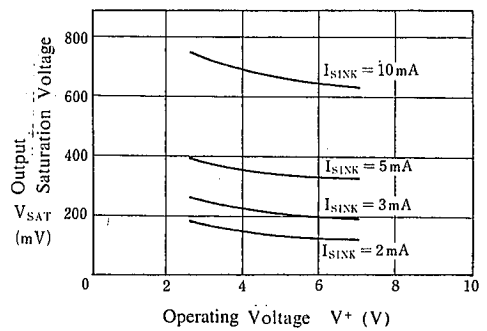

■ TYPICAL CHARACTERISTICS

Response Time for Various Input Over Drives
($T_a = 25^\circ\text{C}$)

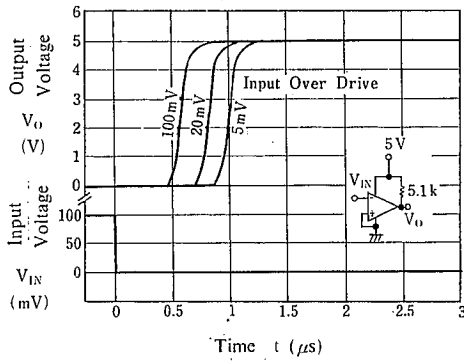

Response Time for Various Input Over Drives
($T_a = 25^\circ\text{C}$)

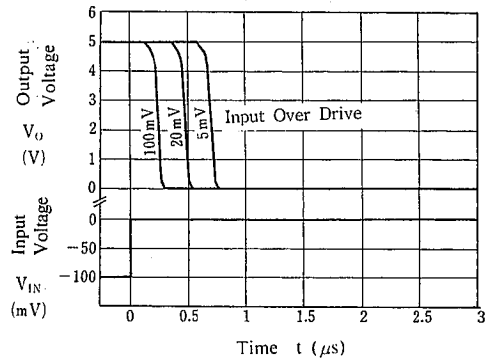

5

MEMO

[CAUTION]

The specifications on this databook are only given for information, without any guarantee as regards either mistakes or omissions. The application circuits in this databook are described only to show representative usages of the product and not intended for the guarantee or permission of any right including the industrial rights.