

Complementary N- and P-Channel 20-V (D-S) MOSFET

PRODUCT SUMMARY			
	V_{DS} (V)	$R_{DS(on)}$ (Ω)	I_D (mA)
N-Channel	20	0.70 at $V_{GS} = 4.5$ V	600
		0.85 at $V_{GS} = 2.5$ V	500
		1.25 at $V_{GS} = 1.8$ V	350
P-Channel	- 20	1.2 at $V_{GS} = - 4.5$ V	- 400
		1.6 at $V_{GS} = - 2.5$ V	- 300
		2.7 at $V_{GS} = - 1.8$ V	- 150

FEATURES

- Halogen-free Option Available
- TrenchFET[®] Power MOSFETs
- 2000 V ESD Protection
- Very Small Footprint
- High-Side Switching
- Low On-Resistance:
N-Channel, 0.7 Ω
P-Channel, 1.2 Ω
- Low Threshold: ± 0.8 V (Typ.)
- Fast Switching Speed: 14 ns
- 1.8 V Operation



RoHS
COMPLIANT

BENEFITS

- Ease in Driving Switches
- Low Offset (Error) Voltage
- Low-Voltage Operation
- High-Speed Circuits
- Low Battery Voltage Operation

APPLICATIONS

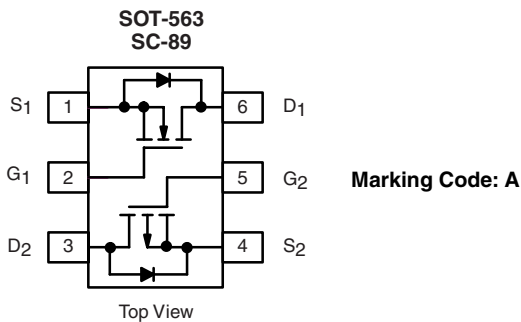
- Replace Digital Transistor, Level-Shifter
- Battery Operated Systems
- Power Supply Converter Circuits
- Load/Power Switching Cell Phones, Pagers



Ordering Information: Si1016X-T1-E3 (Lead (Pb)-free)
Si1016X-T1-GE3 (Lead (Pb)-free and Halogen-free)

ABSOLUTE MAXIMUM RATINGS $T_A = 25$ °C, unless otherwise noted							
Parameter	Symbol	N-Channel		P-Channel		Unit	
		5 s	Steady State	5 s	Steady State		
Drain-Source Voltage	V_{DS}	20		- 20		V	
Gate-Source Voltage	V_{GS}	± 6					
Continuous Drain Current ($T_J = 150$ °C) ^a	I_D	$T_A = 25$ °C	515	485	- 390	- 370	mA
		$T_A = 85$ °C	370	350	- 280	- 265	
Pulsed Drain Current ^b	I_{DM}	650		- 650			
Continuous Source Current (Diode Conduction) ^a	I_S	450	380	- 450	- 380		
Maximum Power Dissipation ^a	P_D	$T_A = 25$ °C	280	250	280	250	mW
		$T_A = 85$ °C	145	130	145	130	
Operating Junction and Storage Temperature Range	T_J, T_{stg}	- 55 to 150				°C	
Gate-Source ESD Rating (HBM, Method 3015)	ESD	2000				V	

Notes:

- a. Surface Mounted on FR4 board.
b. Pulse width limited by maximum junction temperature.

SPECIFICATIONS $T_J = 25\text{ }^\circ\text{C}$, unless otherwise noted							
Parameter	Symbol	Test Conditions	Min.	Typ.	Max.	Unit	
Static							
Gate Threshold Voltage	$V_{GS(th)}$	$V_{DS} = V_{GS}, I_D = 250\text{ }\mu\text{A}$	N-Ch	0.45		1	V
		$V_{DS} = V_{GS}, I_D = -250\text{ }\mu\text{A}$	P-Ch	-0.45		-1	
Gate Body Leakage	I_{GSS}	$V_{DS} = 0\text{ V}, V_{GS} = \pm 4.5\text{ V}$	N-Ch P-Ch		± 0.5 ± 1.0	± 1.0 ± 2.0	μA
Zero Gate Voltage Drain Current	I_{DSS}	$V_{DS} = 16\text{ V}, V_{GS} = 0\text{ V}$	N-Ch		0.3	100	nA
		$V_{DS} = -16\text{ V}, V_{GS} = 0\text{ V}$	P-Ch		-0.3	-100	
		$V_{DS} = 16\text{ V}, V_{GS} = 0\text{ V}, T_J = 85\text{ }^\circ\text{C}$	N-Ch			5	μA
		$V_{DS} = -16\text{ V}, V_{GS} = 0\text{ V}, T_J = 85\text{ }^\circ\text{C}$	P-Ch			-5	
On State Drain Current ^a	$I_{D(on)}$	$V_{DS} = 5\text{ V}, V_{GS} = 4.5\text{ V}$	N-Ch	700			mA
		$V_{DS} = -5\text{ V}, V_{GS} = -4.5\text{ V}$	P-Ch	-700			
Drain-Source On-State Resistance ^a	$R_{DS(on)}$	$V_{GS} = 4.5\text{ V}, I_D = 600\text{ mA}$	N-Ch		0.41	0.70	Ω
		$V_{GS} = -4.5\text{ V}, I_D = -350\text{ mA}$	P-Ch		0.80	1.2	
		$V_{GS} = 2.5\text{ V}, I_D = 500\text{ mA}$	N-Ch		0.53	0.85	
		$V_{GS} = -2.5\text{ V}, I_D = -300\text{ mA}$	P-Ch		1.20	1.6	
		$V_{GS} = 1.8\text{ V}, I_D = 350\text{ mA}$	N-Ch		0.70	1.25	
		$V_{GS} = -1.8\text{ V}, I_D = -150\text{ mA}$	P-Ch		1.80	2.7	
Forward Transconductance ^a	g_{fs}	$V_{DS} = 10\text{ V}, I_D = 400\text{ mA}$	N-Ch		1.0		S
		$V_{DS} = -10\text{ V}, I_D = -250\text{ mA}$	P-Ch		0.4		
Diode Forward Voltage ^a	V_{SD}	$I_S = 150\text{ mA}, V_{GS} = 0\text{ V}$	N-Ch		0.8	1.2	V
		$I_S = -150\text{ mA}, V_{GS} = 0\text{ V}$	P-Ch		-0.8	-1.2	
Dynamic^b							
Total Gate Charge	Q_g	N-Channel $V_{DS} = 10\text{ V}, V_{GS} = 4.5\text{ V}, I_D = 250\text{ mA}$ P-Channel $V_{DS} = -10\text{ V}, V_{GS} = -4.5\text{ V}, I_D = -250\text{ mA}$	N-Ch		750		pC
Gate-Source Charge	Q_{gs}		N-Ch		75		
Gate-Drain Charge	Q_{gd}		N-Ch		225		
Turn-On Time	t_{ON}	N-Channel $V_{DD} = 10\text{ V}, R_L = 47\text{ }\Omega$ $I_D \cong 200\text{ mA}, V_{GEN} = 4.5\text{ V}, R_G = 10\text{ }\Omega$ P-Channel $V_{DD} = -10\text{ V}, R_L = 47\text{ }\Omega$ $I_D \cong -200\text{ mA}, V_{GEN} = -4.5\text{ V}, R_G = 10\text{ }\Omega$	N-Ch		5		ns
Turn-Off Time	t_{OFF}		N-Ch		25		
			P-Ch		35		

Notes:

- a. Pulse test; pulse width $\leq 300\text{ }\mu\text{s}$, duty cycle $\leq 2\%$.
b. Guaranteed by design, not subject to production testing.

Stresses beyond those listed under "Absolute Maximum Ratings" may cause permanent damage to the device. These are stress ratings only, and functional operation of the device at these or any other conditions beyond those indicated in the operational sections of the specifications is not implied. Exposure to absolute maximum rating conditions for extended periods may affect device reliability.

N-CHANNEL TYPICAL CHARACTERISTICS $T_A = 25\text{ }^\circ\text{C}$, unless otherwise noted

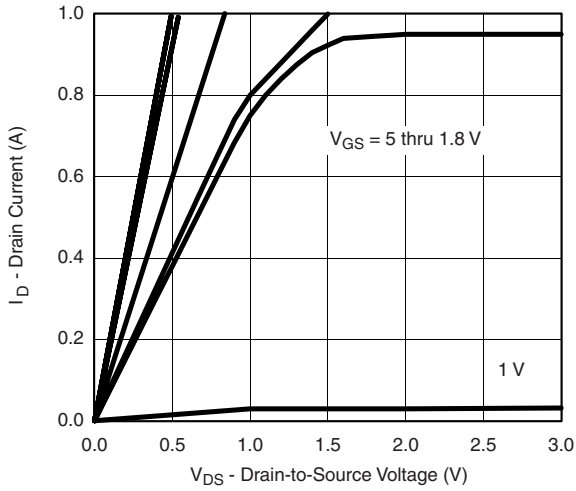

Output Characteristics

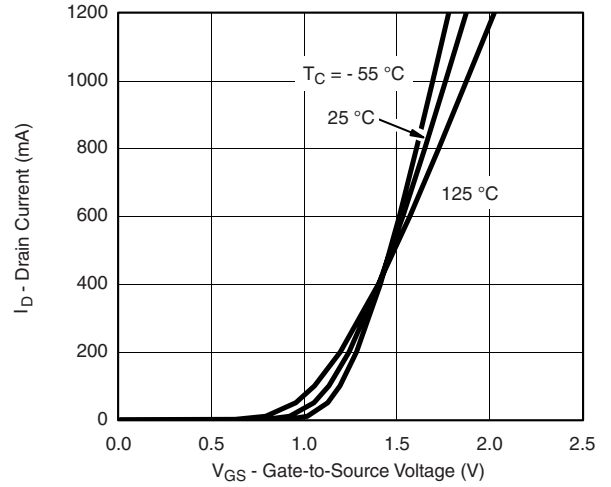

Transfer Characteristics

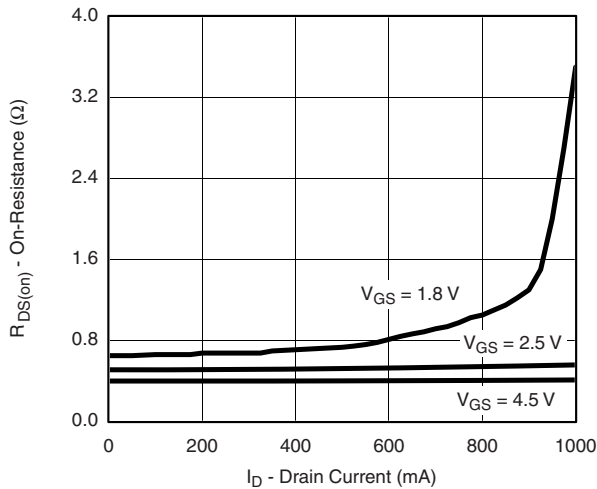

On-Resistance vs. Drain Current

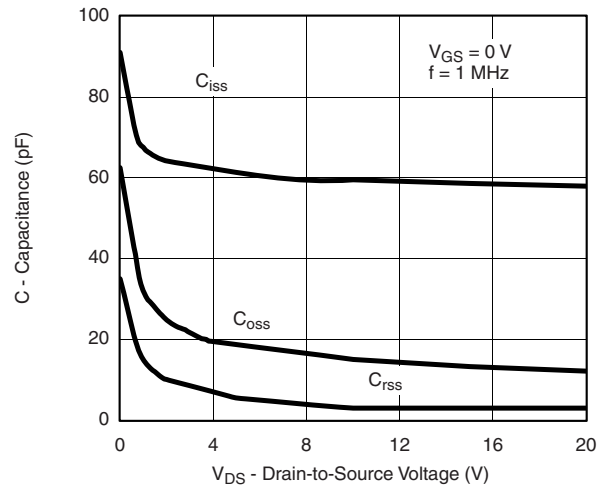

Capacitance

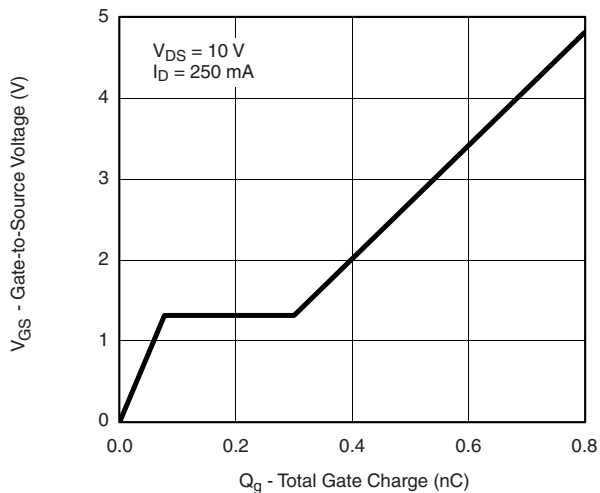

Gate Charge

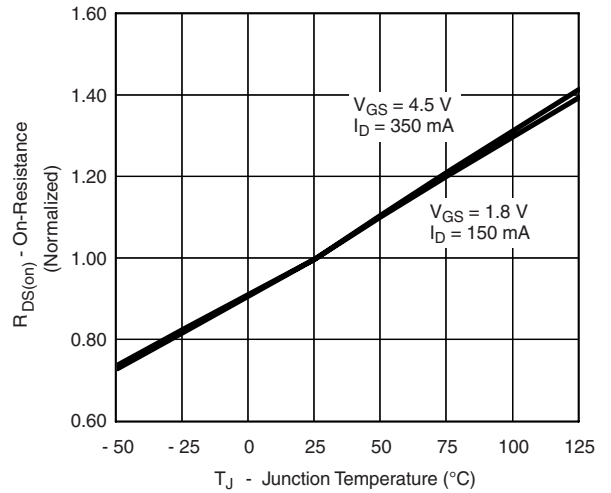

On-Resistance vs. Junction Temperature

N-CHANNEL TYPICAL CHARACTERISTICS $T_A = 25\text{ }^\circ\text{C}$, unless otherwise noted

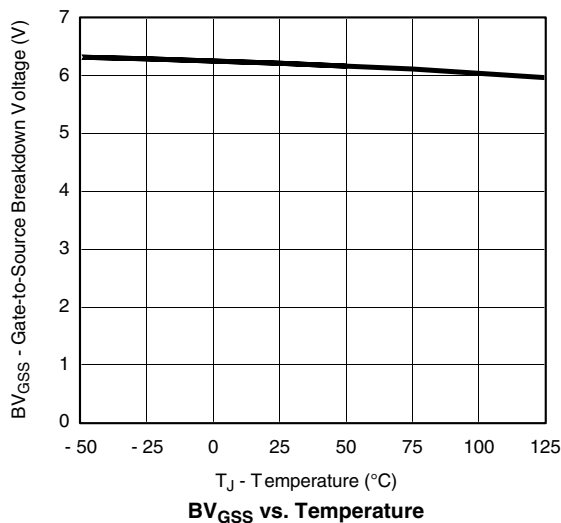
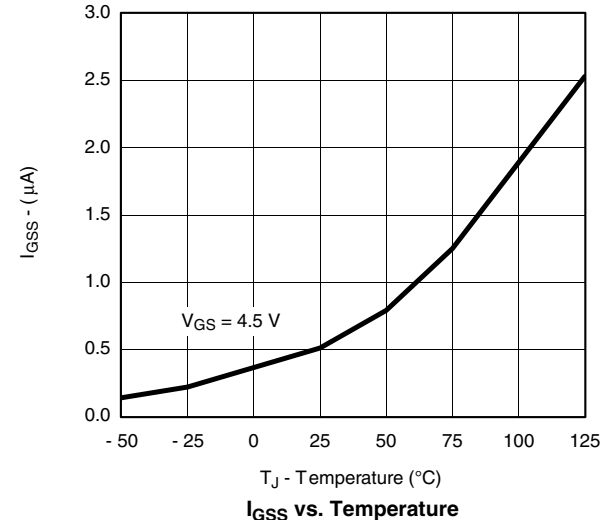
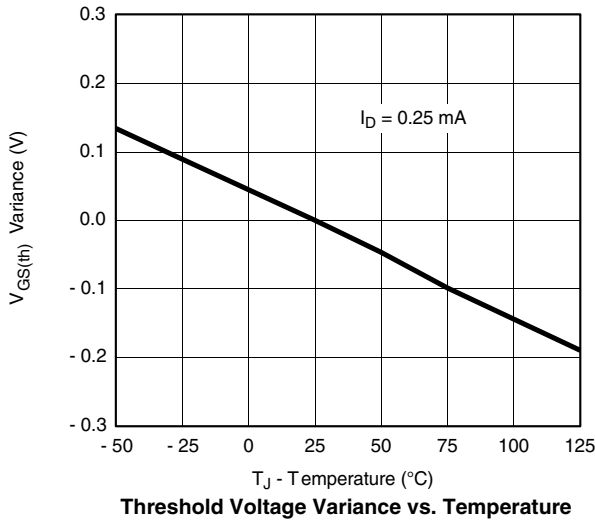
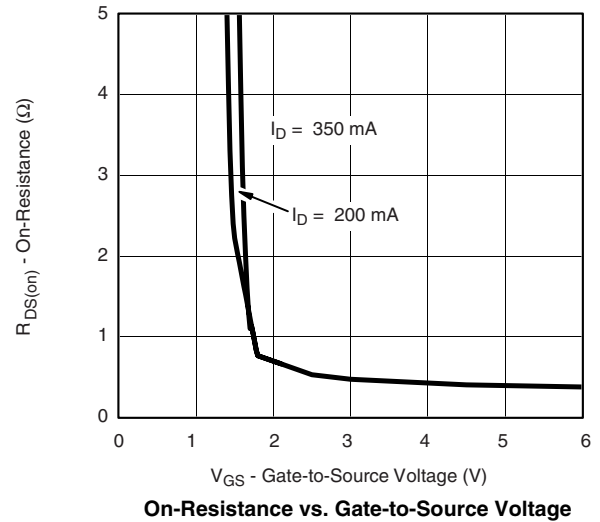
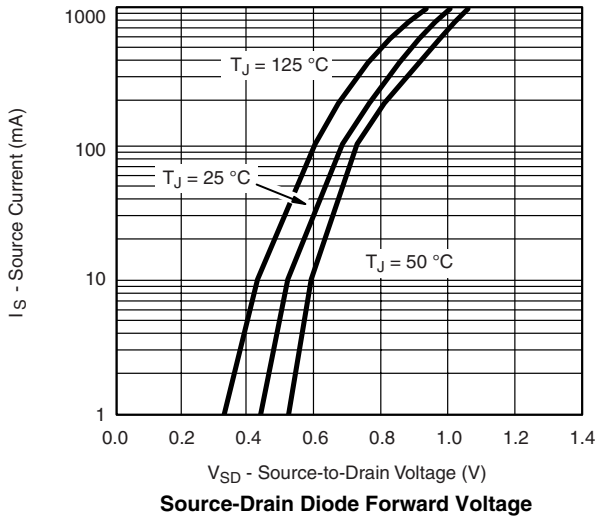

P-CHANNEL TYPICAL CHARACTERISTICS $T_A = 25\text{ }^\circ\text{C}$, unless otherwise noted

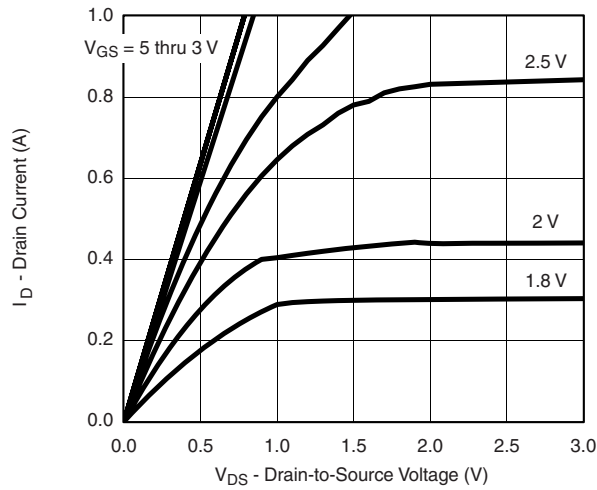

Output Characteristics

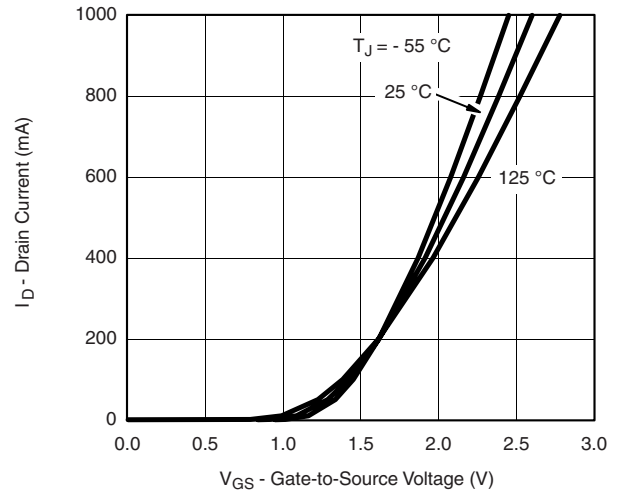

Transfer Characteristics

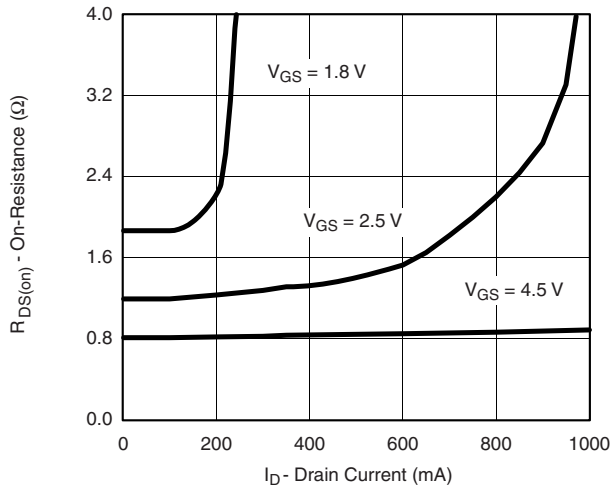

On-Resistance vs. Drain Current

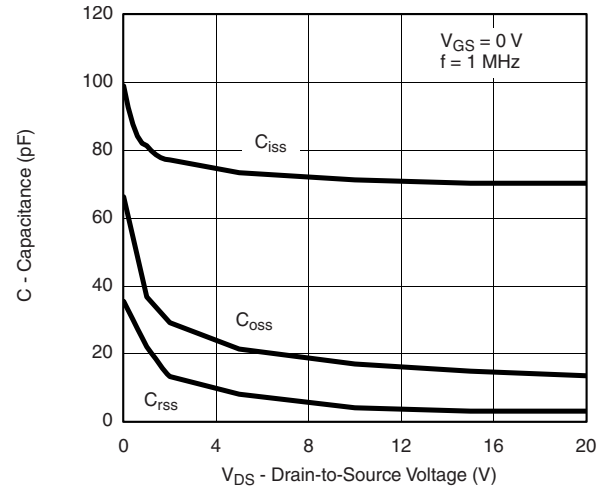

Capacitance

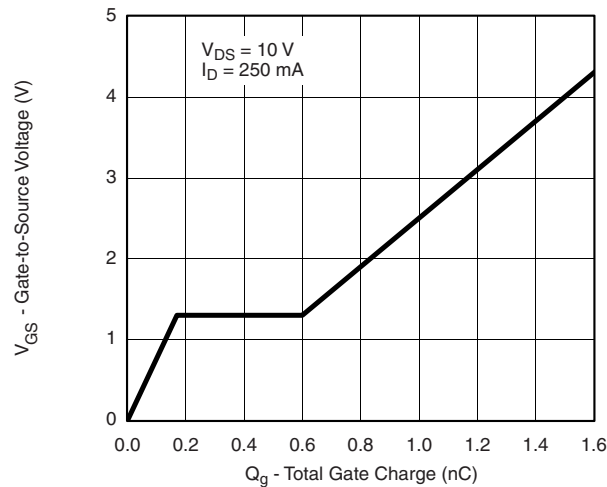

Gate Charge

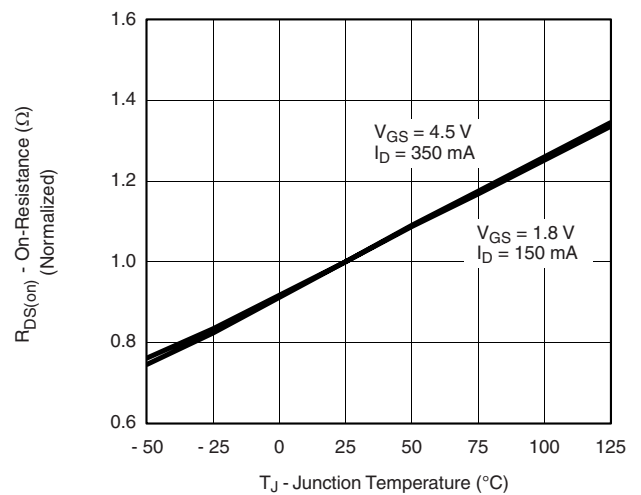

On-Resistance vs. Junction Temperature

P-CHANNEL TYPICAL CHARACTERISTICS $T_A = 25\text{ }^\circ\text{C}$, unless otherwise noted

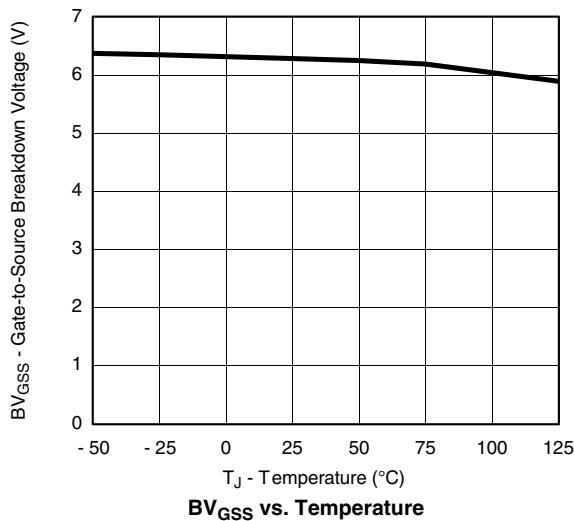
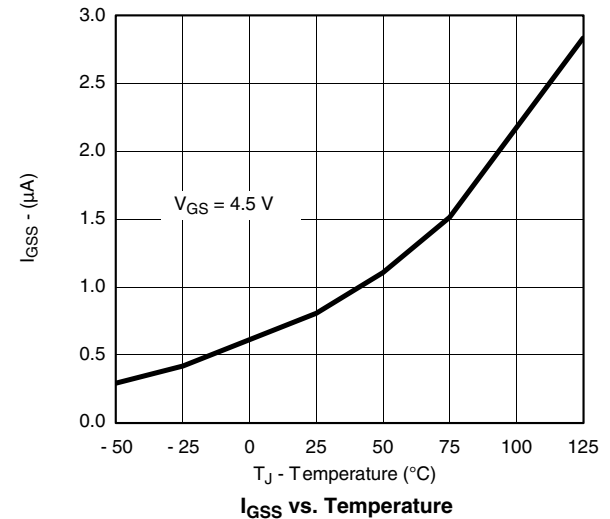
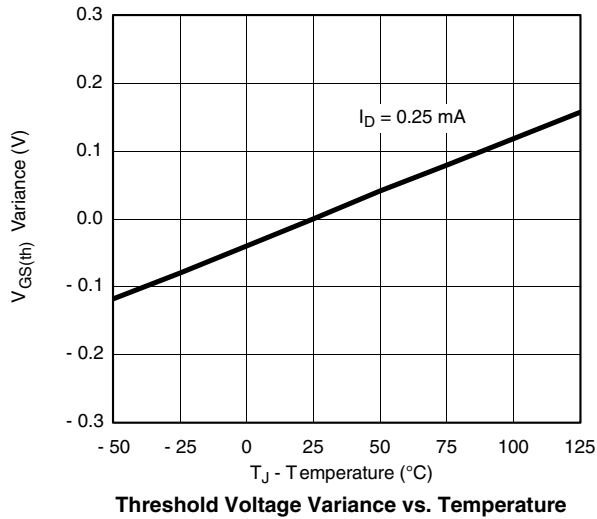
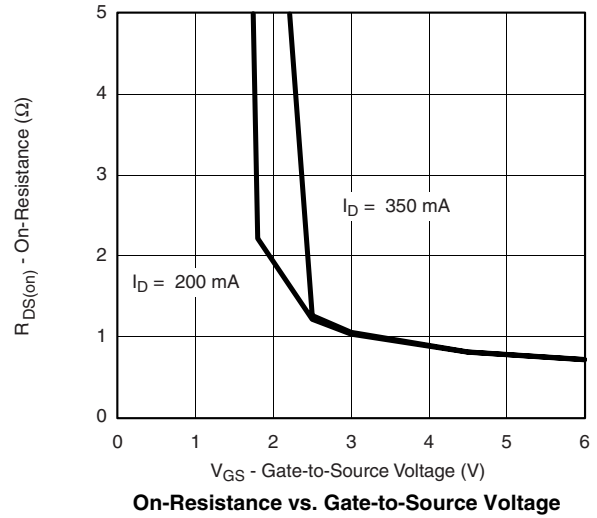
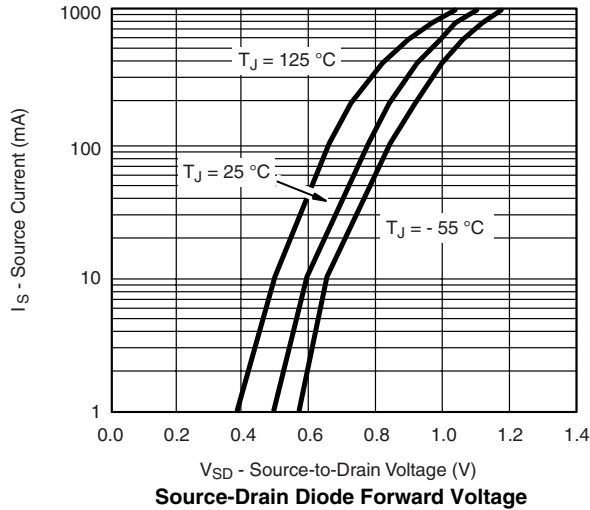

N- OR P-CHANNEL TYPICAL CHARACTERISTICS $T_A = 25\text{ }^\circ\text{C}$, unless otherwise noted

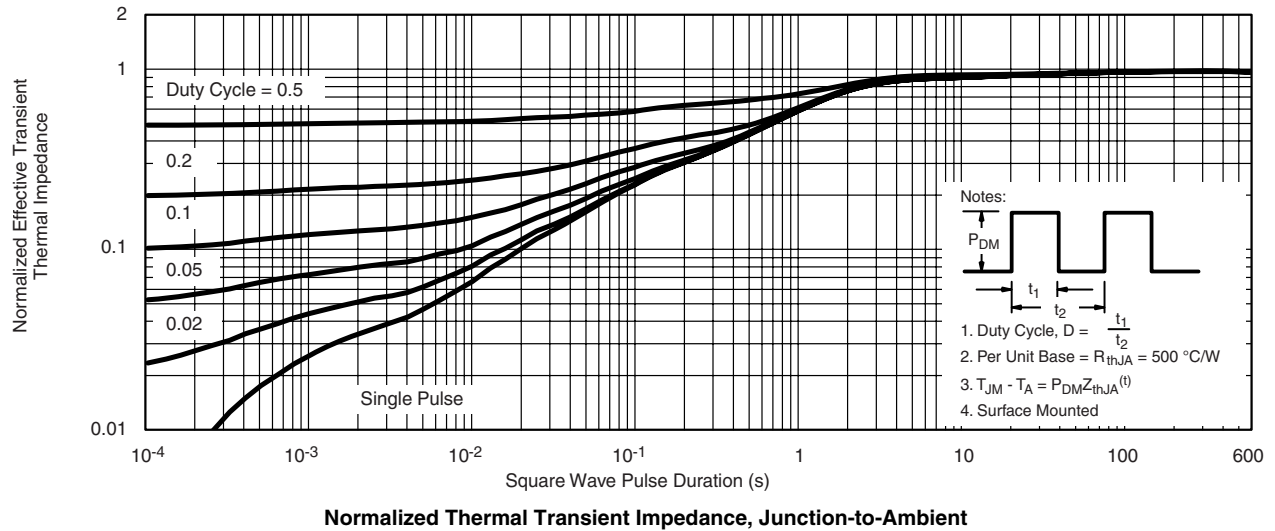

Vishay Siliconix maintains worldwide manufacturing capability. Products may be manufactured at one of several qualified locations. Reliability data for Silicon Technology and Package Reliability represent a composite of all qualified locations. For related documents such as package/tape drawings, part marking, and reliability data, see <http://www.vishay.com/ppg?71168>.



Disclaimer

All product specifications and data are subject to change without notice.

Vishay Intertechnology, Inc., its affiliates, agents, and employees, and all persons acting on its or their behalf (collectively, "Vishay"), disclaim any and all liability for any errors, inaccuracies or incompleteness contained herein or in any other disclosure relating to any product.

Vishay disclaims any and all liability arising out of the use or application of any product described herein or of any information provided herein to the maximum extent permitted by law. The product specifications do not expand or otherwise modify Vishay's terms and conditions of purchase, including but not limited to the warranty expressed therein, which apply to these products.

No license, express or implied, by estoppel or otherwise, to any intellectual property rights is granted by this document or by any conduct of Vishay.

The products shown herein are not designed for use in medical, life-saving, or life-sustaining applications unless otherwise expressly indicated. Customers using or selling Vishay products not expressly indicated for use in such applications do so entirely at their own risk and agree to fully indemnify Vishay for any damages arising or resulting from such use or sale. Please contact authorized Vishay personnel to obtain written terms and conditions regarding products designed for such applications.

Product names and markings noted herein may be trademarks of their respective owners.