

Negative Output Low Drop Out voltage regulator

■ GENERAL DESCRIPTION

The NJM2828 is a negative output low dropout regulator. Advanced bipolar technology achieves low noise, high precision voltage and high ripple rejection.

It has soft-start and shunt SW function. 1.0 μ F Output capacitor and small package can make NJM2828 suitable for portable items.

■ PACKAGE OUTLINE

SC88A

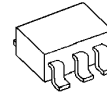

NJM2828F3

■ FEATURES

- Low Current Consumption 0.13V (typ.) @ $I_o=60\text{mA}$
- High Precision Output $\pm 1.5\%$
- High Ripple Rejection 65dB(typ.) @ $f=1\text{kHz}$, $V_o=-7\text{V}$ Version
- Output capacitor with 0.1F ceramic capacitor.
- Output Current $I_o(\text{max.})=100\text{mA}$
- ON/OFF Control(Positive voltage control from 0 to +5V)
- Soft-start Function
- Shunt SW Function
- Internal Thermal Overload Protection
- Internal Short Circuit Current Limit
- Bipolar Technology
- Package Outline SC88A

■ PIN CONFIGURATION

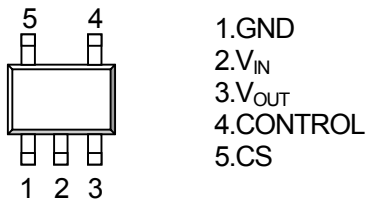

NJM2828F3-XX

■ EQUIVALENT CIRCUIT

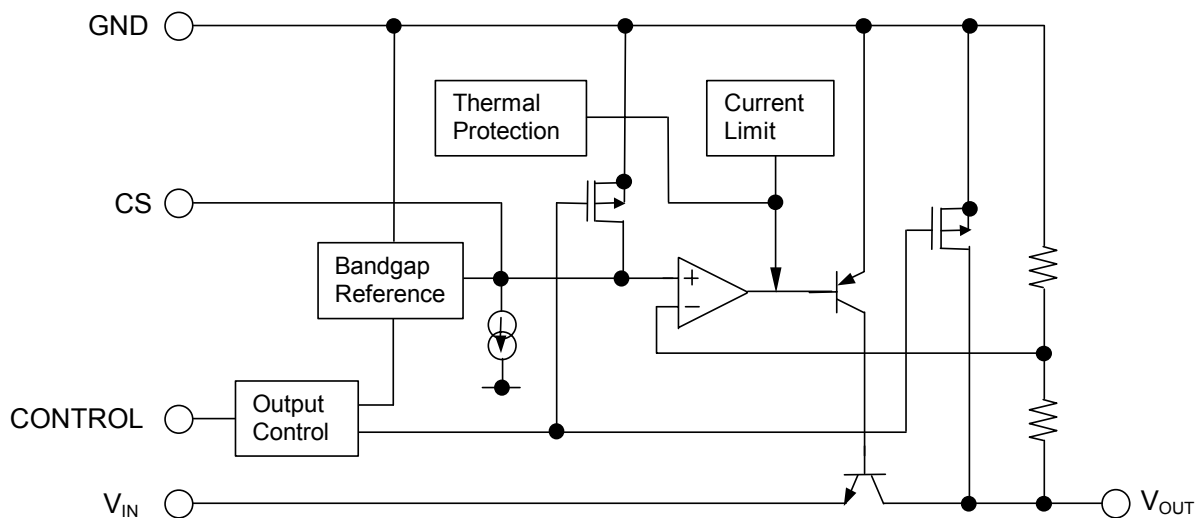

NJM2828

■ OUTPUT VOLTAGE RANK LIST

Device Name	V _{OUT}	Device Name	V _{OUT}
NJM2828F3-14	-1.4V	NJM2828F3-06	-6.0V
NJM2828F3-15	-1.5V	NJM2828F3-63	-6.3V
NJM2828F3-02	-2.0V	NJM2828F3-65	-6.5V
NJM2828F3-03	-3.0V	NJM2828F3-07	-7.0V
NJM2828F3-04	-4.0V	NJM2828F3-75	-7.5V
NJM2828F3-05	-5.0V	NJM2828F3-08	-8.0V
NJM2828F3-51	-5.1V	NJM2828F3-85	-8.5V
NJM2828F3-55	-5.5V	NJM2828F3-10	-10.0V

Output voltage options available : -1.5 ~ -10.0V (0.1V step)

■ ABSOLUTE MAXIMUM RATINGS (Ta=25°C)

PARAMETER	SYMBOL	RATINGS	UNIT
Input Voltage	V _{IN}	-14	V
Control Voltage	V _{CONT}	+5	V
Power Dissipation	P _D	250(*1)	mW
Operating Temperature	T _{opr}	-40 ~ +85	°C
Storage Temperature	T _{stg}	-40 ~ +125	°C
Output Sink Current at OFF-state	I _{SINK(OFF)}	10	mA

(*1): Mounted on glass epoxy board. (114.3×76.2×1.6mm : 2layer,FR-4)

■ Operating voltage

V_{IN}=-3.2 ~ -12V (In case of Vo>-3.0V version)

■ ELECTRICAL CHARACTERISTICS

(Vo<-2.2V Version: V_{IN}=Vo-1V, V_{CONT}=3V, C_{IN}=0.1μF, Co=1.0μF, Ta=25°C)

(Vo≥-2.2V Version: V_{IN}=-3.2V, V_{CONT}=3V, C_{IN}=0.1μF, Co=2.2μF(Vo>-2.0V: Co=4.7μF), Ta=25°C)

PARAMETER	SYMBOL	TEST CONDITION	MIN.	TYP.	MAX.	UNIT
Output Voltage	V _O	I _O =30mA	+1.5%	-	-1.5%	V
Quiescent Current	I _Q	I _O =0mA, except I _{cont}	-	130	200	μA
Quiescent Current at OFF-state	I _{Q(OFF)}	V _{CONT} =0V	-	-	100	nA
Output Current	I _O	V _O +0.3V	100	130	-	mA
Line Regulation	ΔV _O /ΔV _{IN}	V _{IN} =Vo-1V~ -12V, I _O =30mA	-	-	0.10	%/V
Load Regulation	ΔV _O /ΔI _O	I _O =0~60mA	-	-	0.03	%/mA
Dropout Voltage(*2)	ΔV _{I O}	I _O =60mA	-	0.13	0.23	V
Ripple Rejection	RR	e _{in} =200mVrms, f=1kHz, I _O =10mA Vo=-7V Version	-	65	-	dB
Average Temperature Coefficient of Output Voltage	ΔV _O /ΔTa	Ta=0~85°C, I _O =10mA	-	±50	-	ppm/°C
Output Noise Voltage1	V _{NO}	f=10Hz~80kHz, I _O =10mA, Vo=-7V Version	-	100	-	μVrms
CS Terminal Charge Current	I _{CS}	V _{CS} =0V	4	5	6	μA
Output Resistance at OFF-state	R _{O(OFF)}	V _{CONT} =0V, Vo=-7V Version	-	360	-	Ω
Control Current	I _{CONT}	V _{CONT} =1.6V	-	2	4	μA
Control Voltage for ON-state	V _{CONT(ON)}		1.6	-	-	V
Control Voltage for OFF-state	V _{CONT(OFF)}		-	-	0.6	V
Input Voltage	V _{IN}		-12	-	-	V

(*2):Excludes Vo>-3.0V version.

The above specification is a common specification for all output voltages.

Therefore, it may be different from the individual specification for a specific output voltage.

NJM2828

■ TEST CIRCUIT

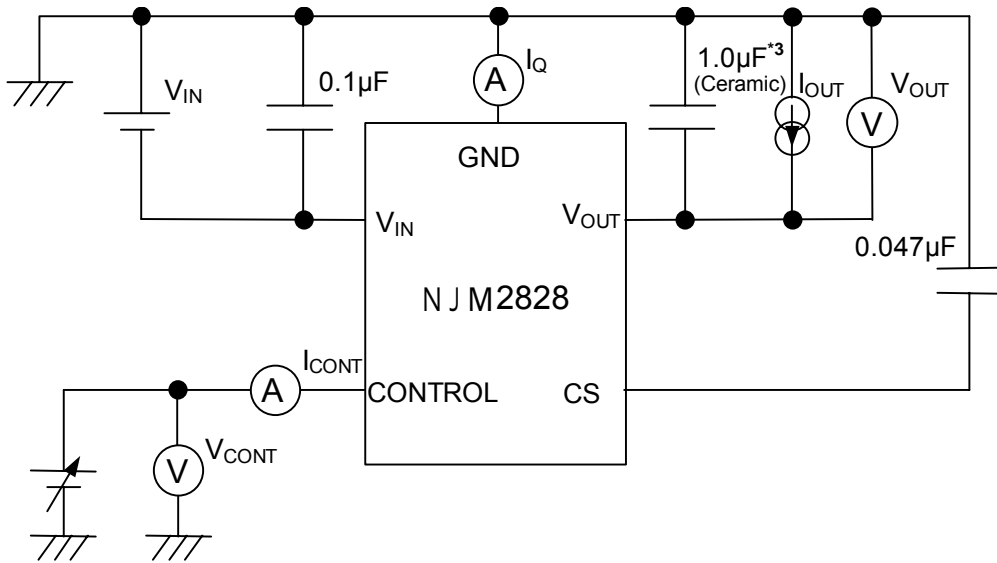

*3 $-2.2V \leq V_o < -2.0V$ version : $C_o = 2.2\mu F$ (Ceramic)
 $V_o \geq -2.0V$ version : $C_o = 4.7\mu F$ (Ceramic)

■ TYPICAL APPLICATIONS

*ON/OFF control

ON/OFF control can be achieved by applying positive control voltage to CONTROL terminal.

Apply positive V_{cont} ("H") to make chip to be ON (Enabled), and either V_{cont} is "L" or open (High Z) to make chip to be OFF (Disabled).

The relations between V_{cont} and the state is as follows:

$V_{cont} + 1.6V \leq V_{cont} \leq +5V$ ("H" level):	ON state
$V_{cont} 0V \leq V_{cont} \leq +0.6V$ ("L" level):	OFF state
$V_{cont} +0.6V < V_{cont} < +1.6V$ ("L" level):	Undefined

In case ON/OFF control is not used, keep applying positive V_{cont} to CONTROL terminal to make chip ON.

Note that negative V_{cont} does not make the chip enabled.

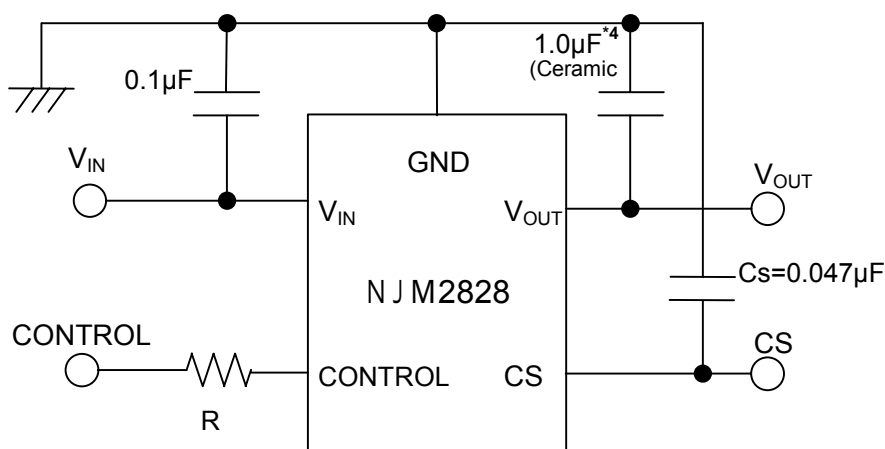

*4 $-2.2V \leq V_o < -2.0V$ version : $C_o = 2.2\mu F$
 $V_o \geq -2.0V$ version : $C_o = 4.7\mu F$

In the case of using a resistance "R" between V_{IN} and control.

The current flow into the control terminal while the IC is ON state (I_{CONT}) can be reduced when a pull up resistance "R" is inserted between V_{IN} and the control terminal.

The minimum control voltage for ON state ($V_{CONT(ON)}$) is increased due to the voltage drop caused by I_{CONT} and the resistance "R". The I_{CONT} is temperature dependence as shown in the "Control Current vs. Temperature" characteristics. Therefore, the resistance "R" should be carefully selected to ensure the control voltage exceeds the $V_{CONT(ON)}$ over the required temperature range.

*Input Capacitance C_{IN}

Input capacitance C_{IN} is required to prevent oscillation and reduce power supply ripple for applications with high power supply impedance or a long power supply line.

Use the C_{IN} value of $0.1\mu F$ greater to avoid the problem.

C_{IN} should connect between GND and V_{IN} as short as possible.

*Output Capacitance C_o

Output capacitor (C_o) is required for a phase compensation of the internal error amplifier. The capacitance and the equivalent series resistance (ESR) influences stability of the regulator.

This product is designed to work with a low ESR capacitor for the C_o ; however, use of recommended capacitance or greater value is essential for stable operation.

Use of a smaller C_o may cause excess output noise or oscillation of the regulator due to lack of the phase compensation.

Therefore, use C_o with the recommended capacitance or greater value and connect between V_o terminal and GND terminal with minimal wiring. The recommended capacitance depends on the output voltage. Low voltage regulator requires greater value of the C_o . Thus, check the recommended capacitance for each output voltage.

Use of a greater C_o reduces output noise and ripple output, and also improves transient response of the output voltage against rapid load change.

*Soft-start function

Capacitance C_s connect between CS pin and GND for the following.

- Control at risetime of output voltage.
- Reduces inrush current at output ON.

When the soft start function is not used, CS pin should be open.

1. C_s capacitance vs risetime of output voltage

Calculation : risetime of output voltage $\Delta t \cong 213 \times C_s(\mu F)$

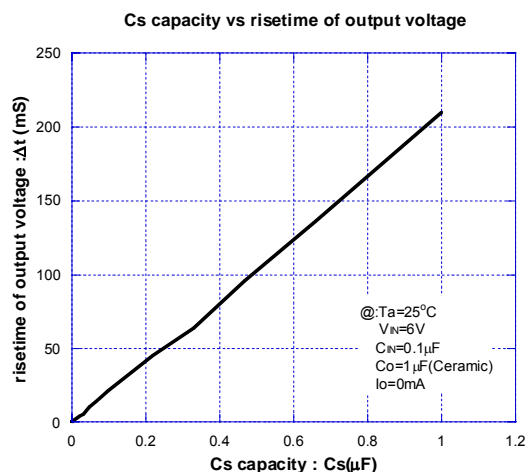

2. Inrush current at control ON

The peak value of the inrush current can be limited according to the capacitance of the C_s .

Inrush current wave :

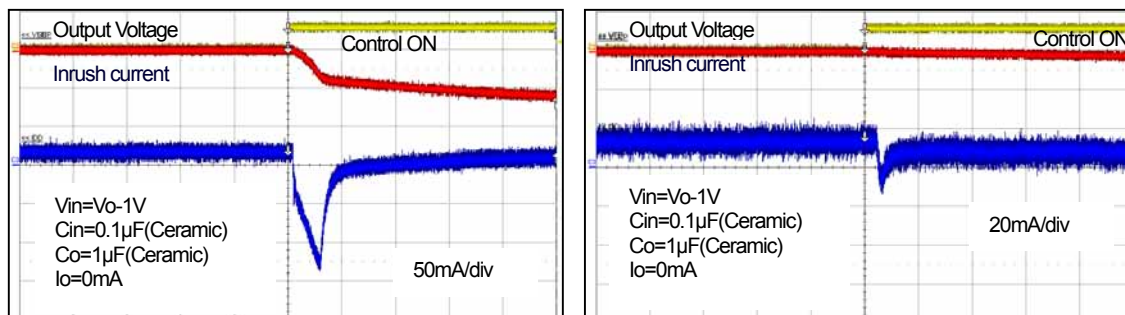

* This characteristic is one example. It is necessary to examine the characteristic with an actual circuit because there is an influence by the characteristic such as output voltage/output capacitor.

NJM2828

POWER DISSIPATION vs. AMBIENT TEMPERATURE

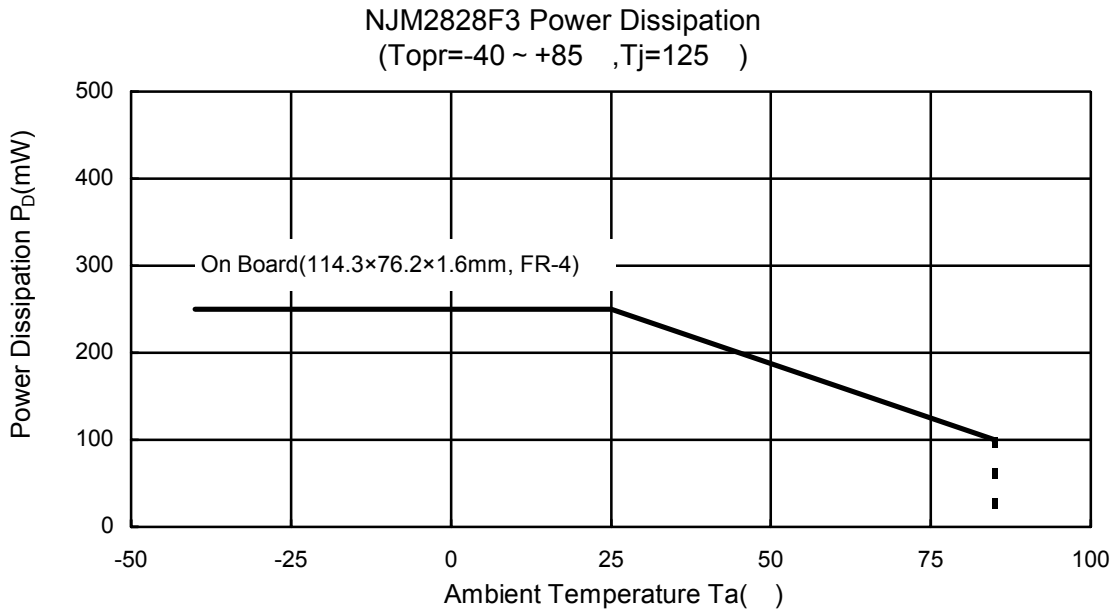

ELECTRICAL CHARACTERISTICS

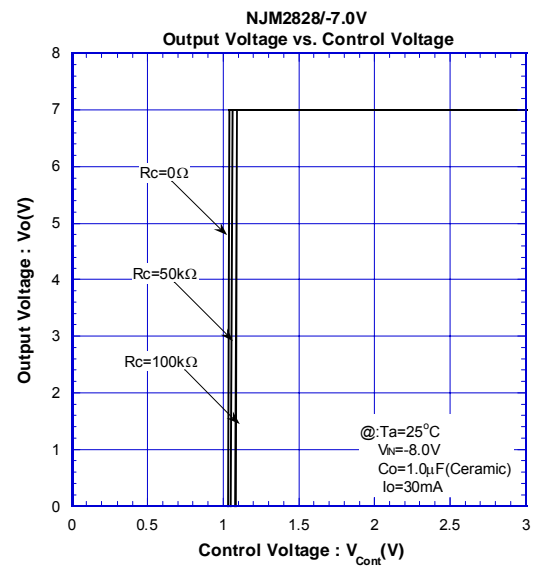
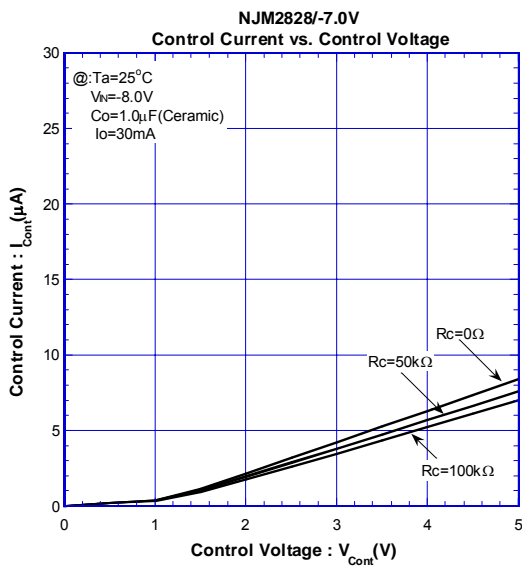
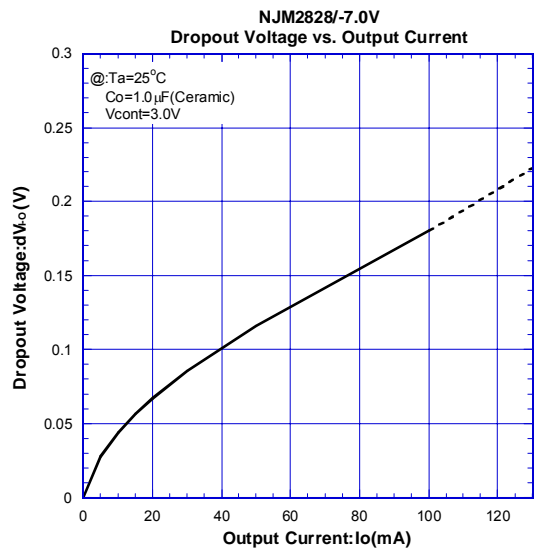
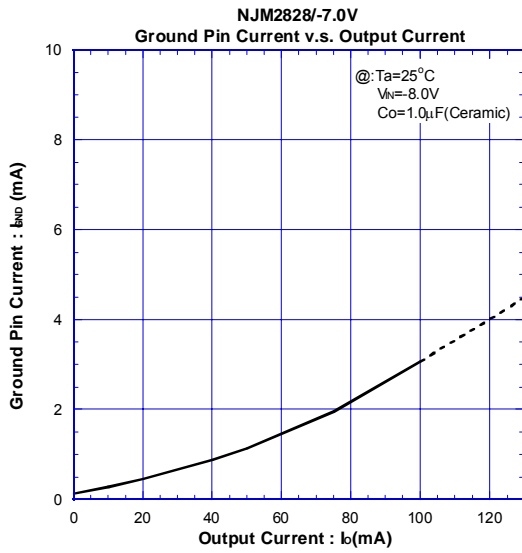
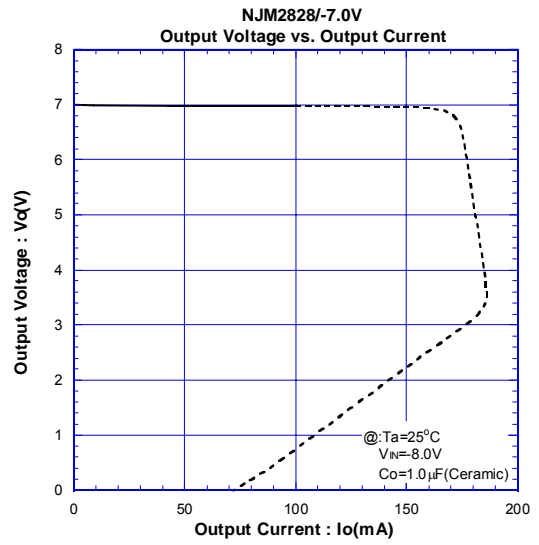
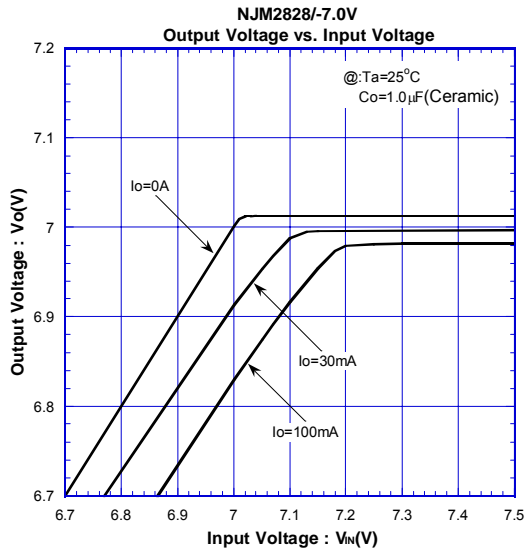

NJM2828

ELECTRICAL CHARACTERISTICS

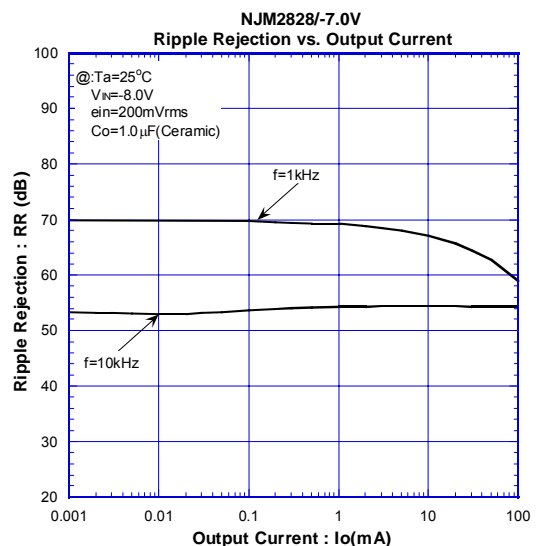
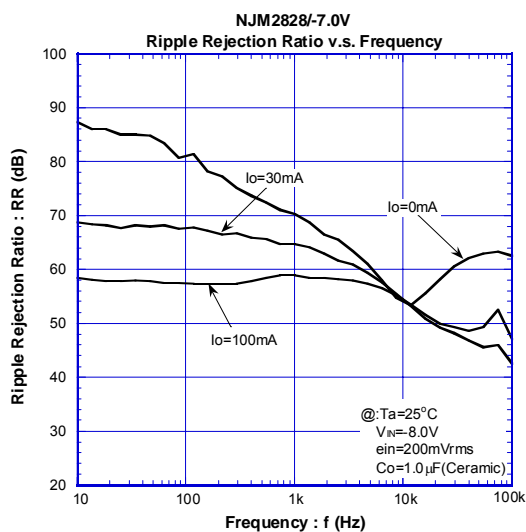
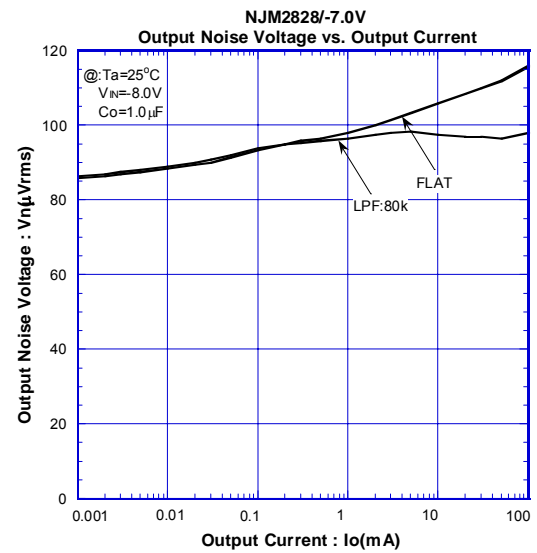
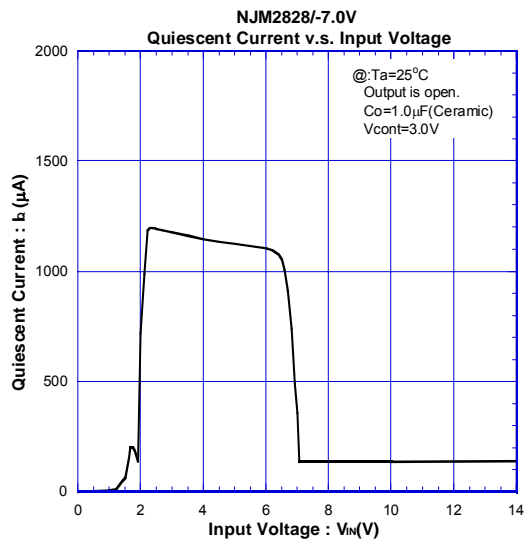
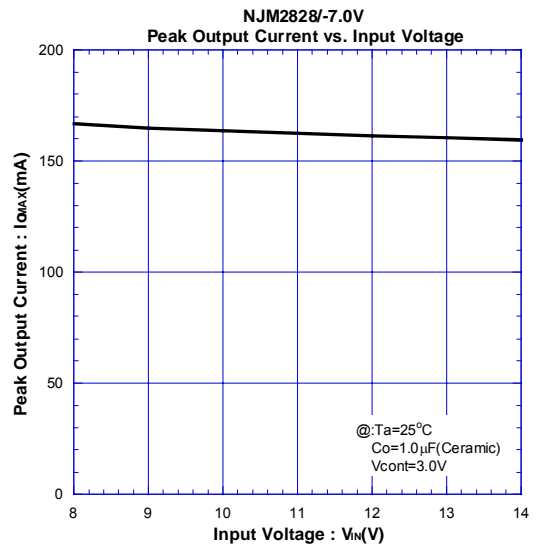
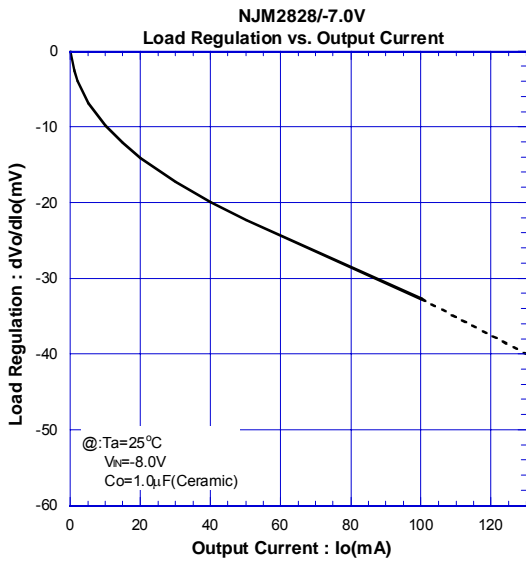

ELECTRICAL CHARACTERISTICS

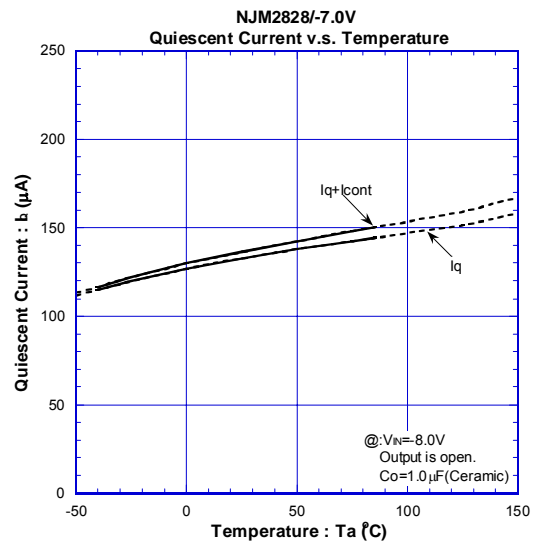
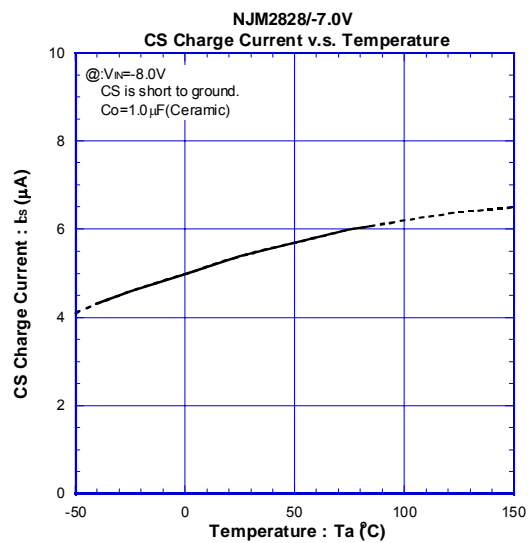
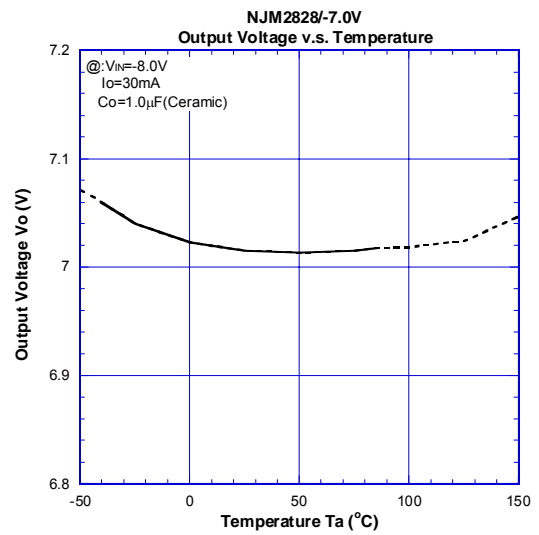
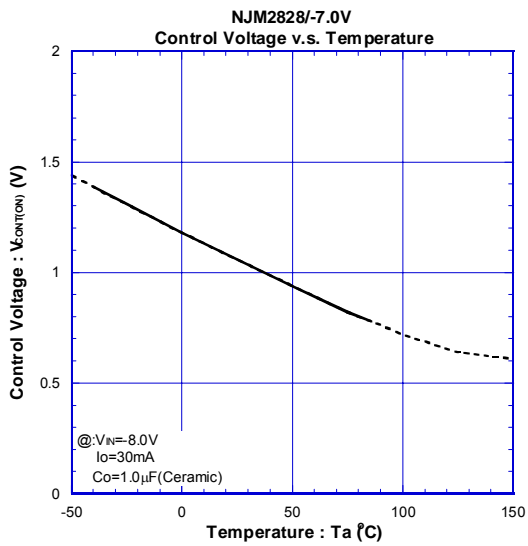
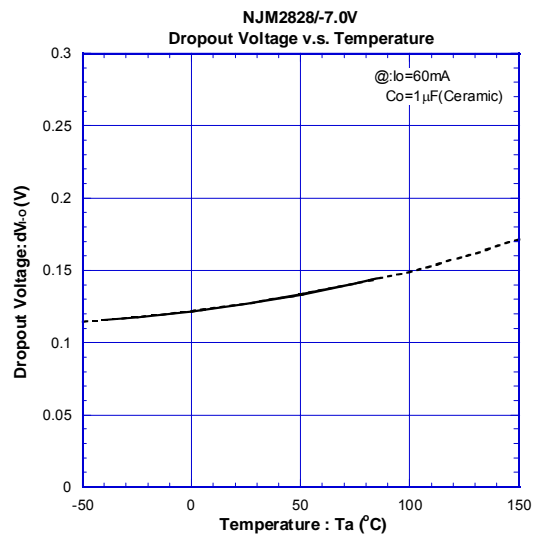
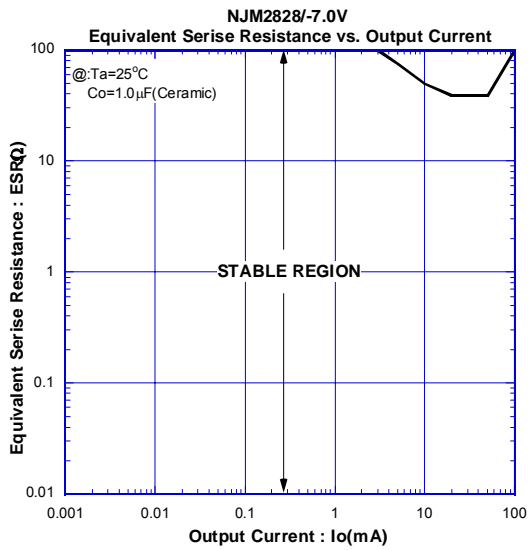

■ ELECTRICAL CHARACTERISTICS

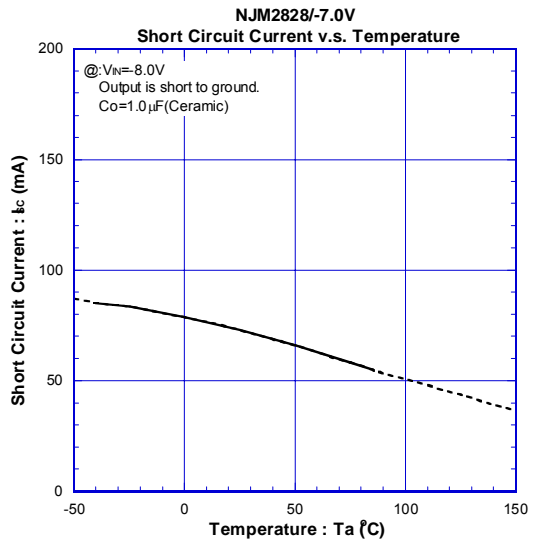
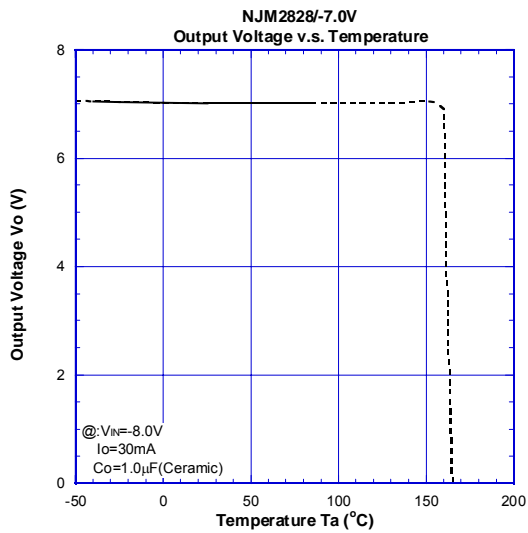
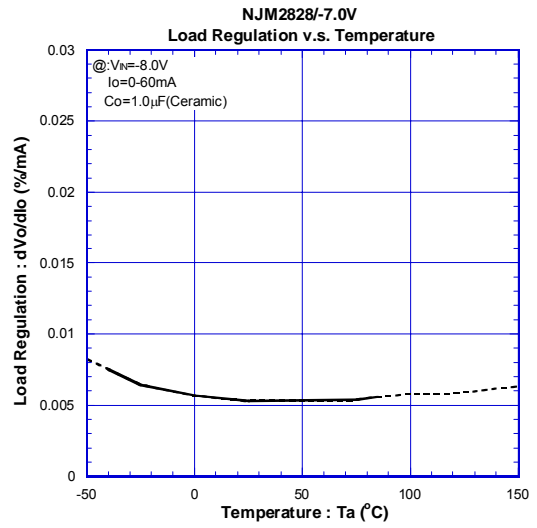
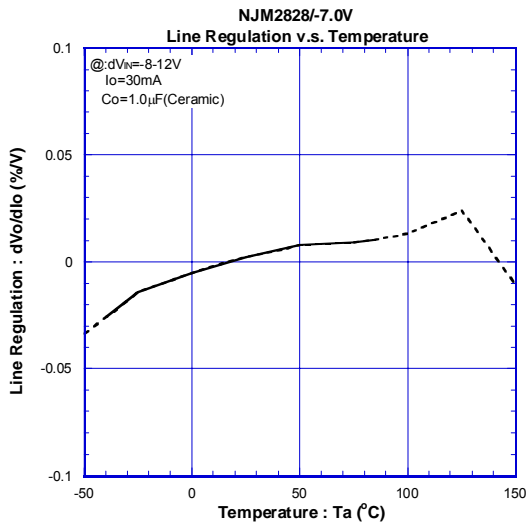

ELECTRICAL CHARACTERISTICS

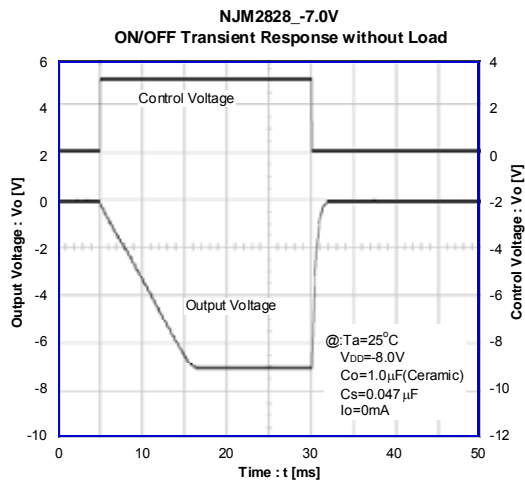
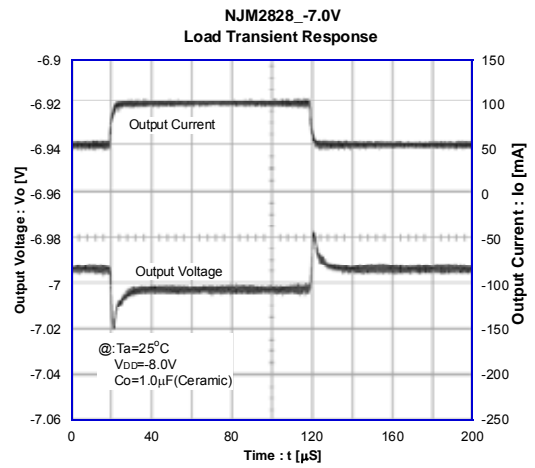
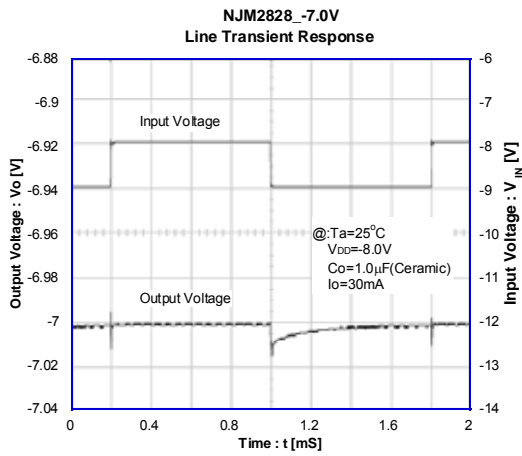

[CAUTION]

The specifications on this databook are only given for information, without any guarantee as regards either mistakes or omissions. The application circuits in this databook are described only to show representative usages of the product and not intended for the guarantee or permission of any right including the industrial rights.