

## NC7SZ74 TinyLogic® UHS D-Type Flip-Flop with Preset and Clear

### General Description

The NC7SZ74 is a single D-type CMOS Flip-Flop with preset and clear from Fairchild's Ultra High Speed Series of TinyLogic® in the space saving US8 package. The device is fabricated with advanced CMOS technology to achieve ultra high speed with high output drive while maintaining low static power dissipation over a very broad  $V_{CC}$  operating range. The device is specified to operate over the 1.65V to 5.5V  $V_{CC}$  range. The inputs and output are high impedance when  $V_{CC}$  is 0V. Inputs tolerate voltages up to 7V independent of  $V_{CC}$  operating voltage.

The signal level applied to the D input is transferred to the Q output during the positive going transition of the CLK pulse.

### Features

- Space saving US8 surface mount package
- MicroPak™ Pb-Free leadless package
- Ultra High Speed;  $t_{PD}$  2.6 ns Typ into 50 pF at 5V  $V_{CC}$
- High Output Drive;  $\pm 24$  mA at 3V  $V_{CC}$
- Broad  $V_{CC}$  Operating Range; 1.65V to 5.5V
- Power down high impedance inputs/output
- Overvoltage tolerant inputs facilitate 5V to 3V translation
- Patented noise/EMI reduction circuitry implemented

### Ordering Code:

Order Number	Package Number	Product Code Top Mark	Package Description	Supplied As
NC7SZ74K8X	MAB08A	SZ74	8-Lead US8, JEDEC MO-187, Variation CA 3.1mm Wide	3k Units on Tape and Reel
NC7SZ74L8X	MAC08A	N9	Pb-Free 8-Lead MicroPak, 1.6 mm Wide	5k Units on Tape and Reel

Pb-Free package per JEDEC J-STD-020B.

TinyLogic® is a registered trademark of Fairchild Semiconductor Corporation.  
MicroPak™ is a trademark of Fairchild Semiconductor Corporation.

NC7SZ74 TinyLogic® UHS D-Type Flip-Flop with Preset and Clear

### Logic Symbol

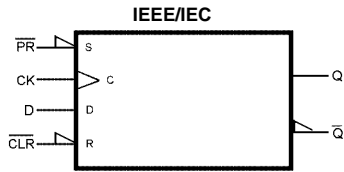

### Pin Descriptions

Pin Names	Description
D	Data Input
CK	Clock Pulse Input
$\overline{\text{CLR}}$	Direct Clear Input
Q, $\overline{\text{Q}}$	Flip-Flop Output
$\overline{\text{PR}}$	Direct Preset Input

### Truth Table

Inputs				Outputs		Function
$\overline{\text{CLR}}$	$\overline{\text{PR}}$	D	CK	Q	$\overline{\text{Q}}$	
L	H	X	X	L	H	Clear
H	L	X	X	H	L	Preset
L	L	X	X	H	H	—
H	H	L	↑	L	H	—
H	H	H	↑	H	L	—
H	H	X	↓	$Q_n$	$\overline{Q}_n$	No Change

H = HIGH Logic Level  
 L = LOW Logic Level  
 $Q_n$  = No change in data  
 Z = High Impedance  
 X = Immaterial  
 ↑ = Rising Edge  
 ↓ = Falling edge

### Connection Diagrams

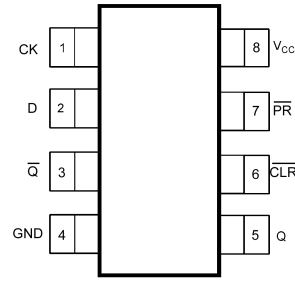

(Top View)

### Pin One Orientation Diagram

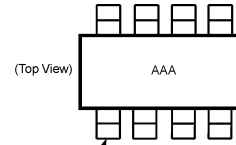

Pin One

AAA represents Product Code Top Mark - see ordering code

**Note:** Orientation of Top Mark determines Pin One location. Read the top product code mark left to right, Pin One is the lower left pin (see diagram).

### Pad Assignments for MicroPak

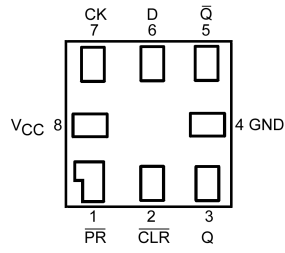

(Top Thru View)

Absolute Maximum Ratings <sup>(Note 1)</sup>			Recommended Operating Conditions <sup>(Note 2)</sup>		
Supply Voltage ( $V_{CC}$ )	-0.5V to +7.0V		Power Supply	Operating ( $V_{CC}$ )	1.65V to 5.5V
DC Input Voltage ( $V_{IN}$ )	-0.5V to +7.0V		Data Retention		1.5V to 5.5V
DC Output Voltage ( $V_{OUT}$ )	-0.5V to +7.0V		Input Voltage ( $V_{IN}$ )		0V to 5.5V
DC Input Diode Current ( $I_{IK}$ )			Output Voltage ( $V_{OUT}$ )	Active State	0V to $V_{CC}$
$V_{IN} < 0V$	-50 mA		3-STATE		0V to 5.5V
DC Output Diode Current ( $I_{OK}$ )			Input Rise and Fall Time ( $t_r, t_f$ )	$V_{CC} = 1.8V, 2.5V \pm 0.2V$	0 to 20 ns/V
$V_{OUT} < 0V$	-50 mA			$V_{CC} = 3.3V \pm 0.3V$	0 to 10 ns/V
DC Output ( $I_{OUT}$ ) Source/Sink Current	$\pm 50$ mA			$V_{CC} = 5.5V \pm 0.5V$	0 to 5 ns/V
DC $V_{CC}/GND$ Current ( $I_{CC}/I_{GND}$ )	$\pm 50$ mA		Operating Temperature ( $T_A$ )		-40°C to +85°C
Storage Temperature Range ( $T_{STG}$ )	-65°C to +150°C		Thermal Resistance ( $\theta_{JA}$ )		250°C/W
Junction Temperature under Bias ( $T_J$ )	150°C				
Junction Lead Temperature ( $T_L$ )					
(Soldering, 10 seconds)	260°C				
Power Dissipation ( $P_D$ ) @ +85°C	250 mW				

**Note 1:** Absolute Maximum Ratings: are those values beyond which the safety of the device cannot be guaranteed. The device should not be operated at these limits. The parametric values defined in the Electrical Characteristics tables are not guaranteed at the absolute maximum ratings. The "Recommended Operating Conditions" table will define the conditions for actual device operation.

**Note 2:** Unused inputs must be held HIGH or LOW. They may not float.

### DC Electrical Characteristics

Symbol	Parameter	$V_{CC}$ (V)	$T_A = +25^\circ C$			$T_A = -40^\circ C$ to $+85^\circ C$		Units	Conditions	
			Min	Typ	Max	Min	Max			
$V_{IH}$	HIGH Level Control Input Voltage	1.65 to 1.95	0.75 $V_{CC}$			0.75 $V_{CC}$		V		
		2.3 to 5.5	0.75 $V_{CC}$			0.7 $V_{CC}$				
$V_{IL}$	LOW Level Control Input Voltage	1.65 to 1.95	0.25 $V_{CC}$			0.25 $V_{CC}$		V		
		2.3 to 5.5	0.3 $V_{CC}$			0.3 $V_{CC}$				
$V_{OH}$	HIGH Level Control Output Voltage	1.65	1.55	1.65	1.55		V	$V_{IN} = V_{IH}$	$I_{OH} = -100 \mu A$	
		2.3	2.2	2.3	2.2					
		3.0	2.9	3.0	2.9					
		4.5	4.4	4.5	4.4					
			1.65	1.29	1.52	1.29		V	$V_{IN} = V_{IH}$	$I_{OH} = -4$ mA
			2.3	1.9	2.15	1.9				
			3.0	2.4	2.8	2.4				
			3.0	2.3	2.68	2.3				
			4.5	3.8	4.2	3.8				
			3.8	4.2		3.8				
$V_{OL}$	LOW Level Control Output Voltage	1.65	0.1			0.1		V	$V_{IN} = V_{IH}$	$I_{OL} = 100 \mu A$
		2.3	0.1			0.1				
		3.0	0.1			0.1				
		4.5	0.1			0.1				
			1.65	0.08	0.24	0.24		V	$V_{IN} = V_{IH}$	$I_{OL} = 4$ mA
			2.3	0.10	0.3	0.3				
			3.0	0.15	0.4	0.4				
			3.0	0.22	0.55	0.55				
			4.5	0.22	0.55	0.55				
			0.22	0.55		0.55				
$I_{IN}$	Input Leakage Current	0 to 5.5	$\pm 0.1$			$\pm 1.0$		$\mu A$	$0 \leq V_{IN} \leq 5.5V$	
$I_{OFF}$	Power Off Leakage Current	0.0	1.0			10		$\mu A$	$V_{IN}$ or $V_{OUT} = 5.5V$	
$I_{CC}$	Quiescent Supply Current	1.65 to 5.5	1.0			10.0		$\mu A$	$V_{IN} = 5.5V, GND$	

AC Electrical Characteristics										
Symbol	Parameter	V <sub>CC</sub> (V)	T <sub>A</sub> = +25°C			T <sub>A</sub> = -40°C to +85°C		Units	Conditions	Figure Number
			Min	Typ	Max	Min	Max			
f <sub>MAX</sub>	Maximum Clock Frequency	1.8 ± 0.15	75			75		MHz	C <sub>L</sub> = 15 pF R <sub>D</sub> = 1 MΩ S <sub>1</sub> = Open	Figures 1, 5
		2.5 ± 0.2	150			150				
		3.3 ± 0.3	200			200				
		5.0 ± 0.5	250			250				
		3.3 ± 0.3	175			175				
		5.0 ± 0.5	200			200				
t <sub>PLH</sub> t <sub>PHL</sub>	Propagation Delay CK to Q, $\bar{Q}$	1.8 ± 0.15	2.5	6.5	12.5	2.5	13.0	ns	C <sub>L</sub> = 15 pF R <sub>D</sub> = 1 MΩ S <sub>1</sub> = Open	Figures 1, 3
		2.5 ± 0.2	1.5	3.8	7.5	1.5	8.0			
		3.3 ± 0.3	1.0	2.8	6.5	1.0	7.0			
		5.0 ± 0.5	0.8	2.2	4.5	0.8	5.0			
		3.3 ± 0.3	1.0	3.4	7.0	1.0	7.5			
		5.0 ± 0.5	1.0	2.6	5.0	1.0	5.5			
t <sub>PLH</sub> t <sub>PHL</sub>	Propagation Delay $\overline{\text{CLR}}$ , $\overline{\text{PR}}$ , to Q, $\bar{Q}$	1.8 ± 0.15	2.5	6.5	14.0	2.5	14.5	ns	C <sub>L</sub> = 15 pF R <sub>D</sub> = 1 MΩ S <sub>1</sub> = Open	Figures 1, 3
		2.5 ± 0.2	1.5	3.8	9.0	1.5	9.5			
		3.3 ± 0.3	1.0	2.8	6.5	1.0	7.0			
		5.0 ± 0.5	0.8	2.2	5.0	0.8	5.5			
		3.3 ± 0.3	1.0	3.4	7.0	1.0	7.5			
		5.0 ± 0.5	1.0	2.6	5.0	1.0	5.5			
t <sub>S</sub>	Setup Time, CK to D	1.8 ± 0.15	6.5			6.5		ns	C <sub>L</sub> = 15 pF R <sub>D</sub> = 1 MΩ S <sub>1</sub> = Open	Figures 1, 4
		2.5 ± 0.2	3.5			3.5				
		3.3 ± 0.3	2.0			2.0				
		5.0 ± 0.5	1.5			1.5				
		3.3 ± 0.3	2.0			2.0				
		5.0 ± 0.5	1.5			1.5				
t <sub>H</sub>	Hold Time, CK to D	1.8 ± 0.15	0.5			0.5		ns	C <sub>L</sub> = 15 pF R <sub>D</sub> = 1 MΩ S <sub>1</sub> = Open	Figures 1, 4
		2.5 ± 0.2	0.5			0.5				
		3.3 ± 0.3	0.5			0.5				
		5.0 ± 0.5	0.5			0.5				
		3.3 ± 0.3	0.5			0.5				
		5.0 ± 0.5	0.5			0.5				
t <sub>W</sub>	Pulse Width, CK, $\overline{\text{PR}}$ , $\overline{\text{CLR}}$	1.8 ± 0.15	6.0			6.0		ns	C <sub>L</sub> = 15 pF R <sub>D</sub> = 1 MΩ S <sub>1</sub> = Open	Figures 1, 5
		2.5 ± 0.2	4.0			4.0				
		3.3 ± 0.3	3.0			3.0				
		5.0 ± 0.5	2.0			2.0				
		3.3 ± 0.3	3.0			3.0				
		5.0 ± 0.5	2.0			2.0				
t <sub>REC</sub>	Recover Time $\overline{\text{CLR}}$ , $\overline{\text{PR}}$ to CK	1.8 ± 0.15	8.0			8.0		ns	C <sub>L</sub> = 15 pF R <sub>D</sub> = 1 MΩ S <sub>1</sub> = Open	Figures 1, 4
		2.5 ± 0.2	4.5			4.5				
		3.3 ± 0.3	3.0			3.0				
		5.0 ± 0.5	3.0			3.0				
		3.3 ± 0.3	3.0			3.0				
		5.0 ± 0.5	3.0			3.0				
Capacitance (Note 3)										
Symbol	Parameter	Typ	Max	Units	Conditions					
C <sub>IN</sub>	Input Capacitance	3		pF	V <sub>CC</sub> = 0V					
C <sub>OUT</sub>	Output Capacitance	4		pF	V <sub>CC</sub> = 0V					
C <sub>PD</sub>	Power Dissipation Capacitance (Note 4)	10		pF	V <sub>CC</sub> = 3.3V					
		12			V <sub>CC</sub> = 5.0V					
<p><b>Note 3:</b> T<sub>A</sub> = +25C, f = 1MHz.</p> <p><b>Note 4:</b> C<sub>PD</sub> is defined as the value of the internal equivalent capacitance which is derived from dynamic operating current consumption (I<sub>CCD</sub>) at no output loading and operating at 50% duty cycle. (See Figure 2) C<sub>PD</sub> is related to I<sub>CCD</sub> dynamic operating current by the expression: I<sub>CCD</sub> = (C<sub>PD</sub>) (V<sub>CC</sub>) (f<sub>IN</sub>) + (I<sub>CCstatic</sub>).</p>										

## AC Loading and Waveforms

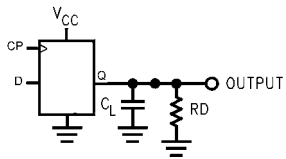

$C_L$  includes load and stray capacitance  
 Input PRR = 1.0 MHz;  $t_w = 500$  ns

**FIGURE 1. AC Test Circuit**

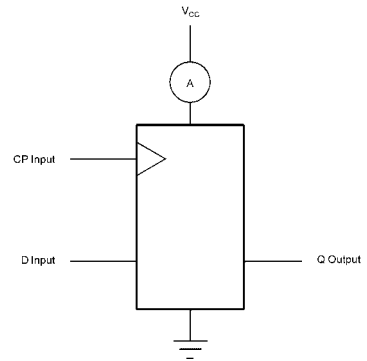

CP Input = AC Waveform;  $t_r = t_f = 2.5$  ns;  
 CP Input PRR = 10 MHz; Duty Cycle = 50%  
 D Input PRR = 5MHz; Duty Cycle = 50%

**FIGURE 2.  $I_{CCD}$  Test Circuit**

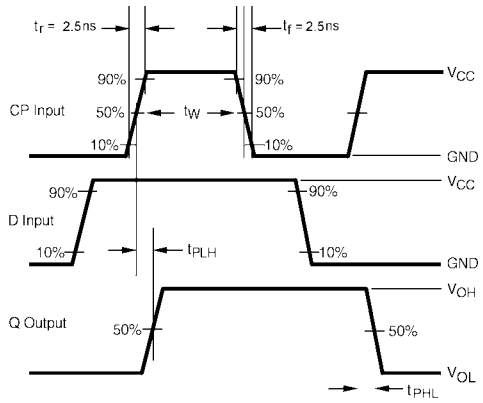

**FIGURE 3. AC Waveforms**

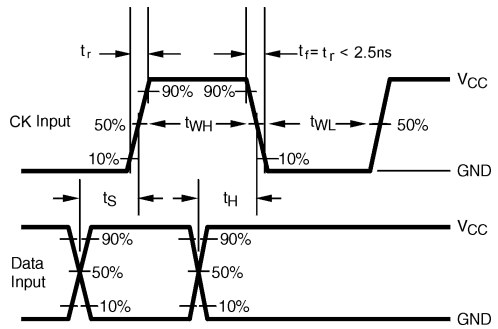

**FIGURE 4. AC Waveforms**

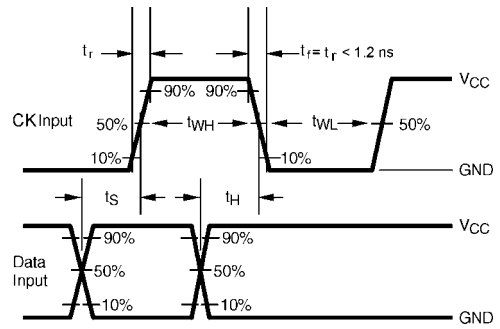

**FIGURE 5. AC Waveforms**

### Tape and Reel Specification

#### TAPE FORMAT for US8

Package Designator	Tape Section	Number Cavities	Cavity Status	Cover Tape Status
K8X	Leader (Start End)	125 (typ)	Empty	Sealed
	Carrier	3000	Filled	Sealed
	Trailer (Hub End)	75 (typ)	Empty	Sealed

#### TAPE DIMENSIONS inches (millimeters)

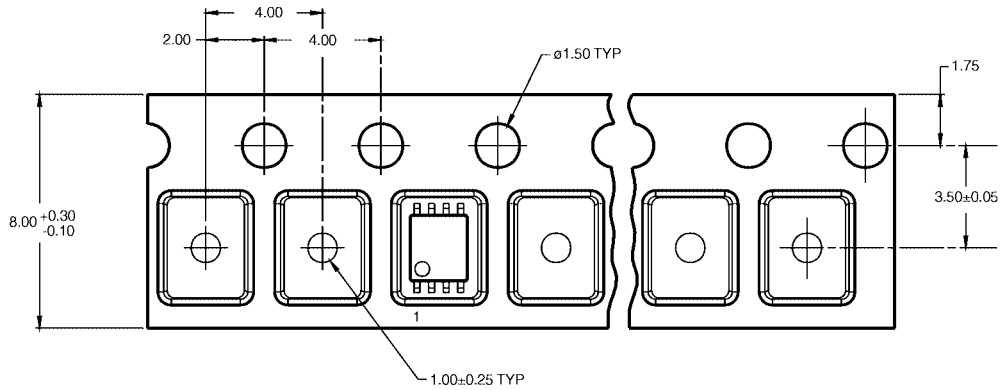

#### TAPE FORMAT for MicroPak

Package Designator	Tape Section	Number Cavities	Cavity Status	Cover Tape Status
L8X	Leader (Start End)	125 (typ)	Empty	Sealed
	Carrier	3000	Filled	Sealed
	Trailer (Hub End)	75 (typ)	Empty	Sealed

#### TAPE DIMENSIONS inches (millimeters)

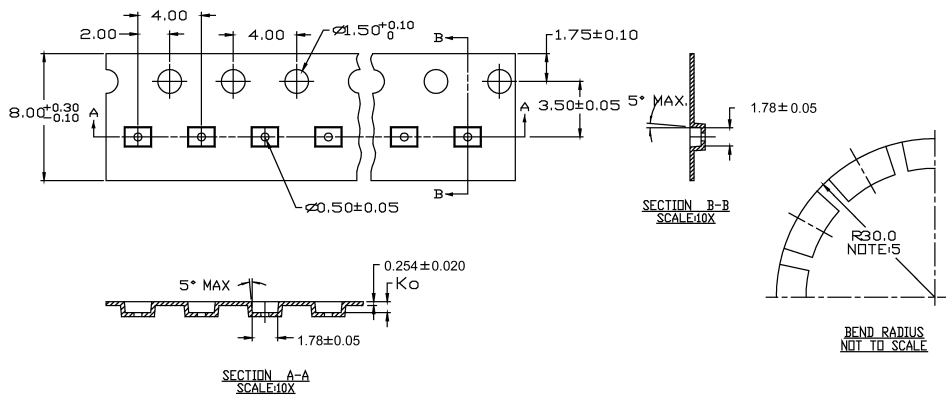

**Tape and Reel Specification** (Continued)

REEL DIMENSIONS inches (millimeters)

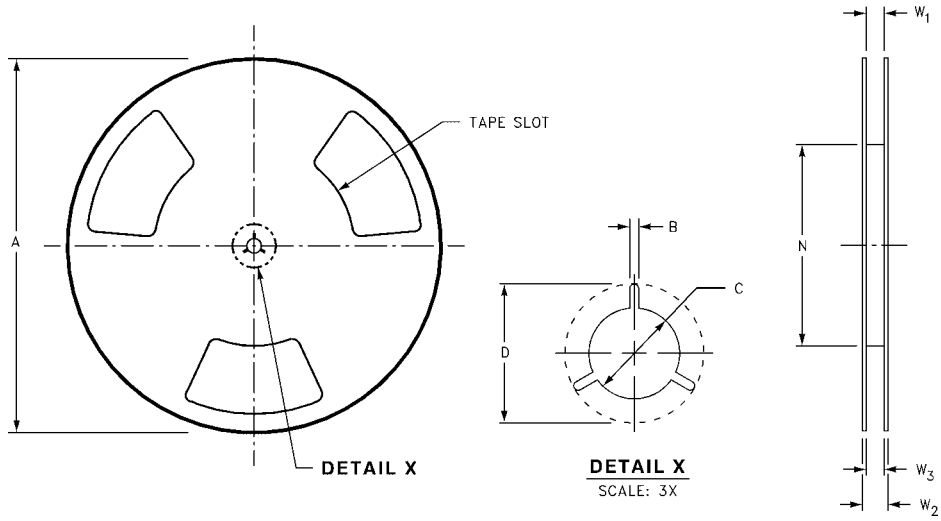

Tape Size	A	B	C	D	N	W1	W2	W3
8 mm	7.0 (177.8)	0.059 (1.50)	0.512 (13.00)	0.795 (20.20)	2.165 (55.00)	0.331 + 0.059/-0.000 (8.40 + 1.50/-0.00)	0.567 (14.40)	W1 + 0.078/-0.039 (W1 + 2.00/-1.00)

**Physical Dimensions** inches (millimeters) unless otherwise noted

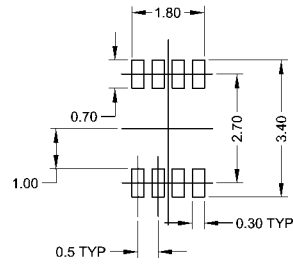
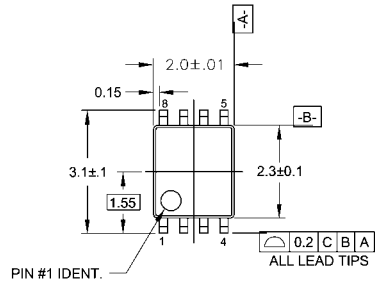

LAND PATTERN RECOMMENDATION

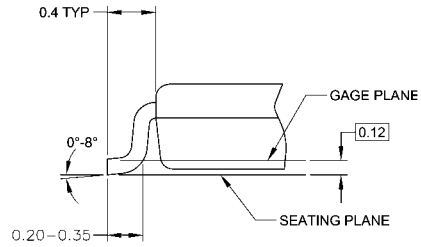
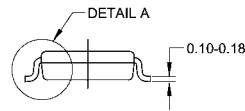
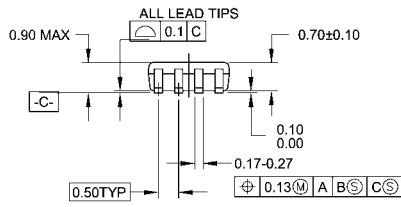

DETAIL A

NOTES:

- A. CONFORMS TO JEDEC REGISTRATION MO-187
- B. DIMENSIONS ARE IN MILLIMETERS.
- C. DIMENSIONS ARE EXCLUSIVE OF BURRS, MOLD FLASH, AND TIE BAR EXTRUSIONS.
- D. DIMENSIONS AND TOLERANCES PER ANSI Y14.5M, 1982.

MAB08AREVC

**8-Lead US8, JEDEC MO-187, Variation CA 3.1mm Wide  
Package Number MAB08A**



**Physical Dimensions** inches (millimeters) unless otherwise noted (Continued)

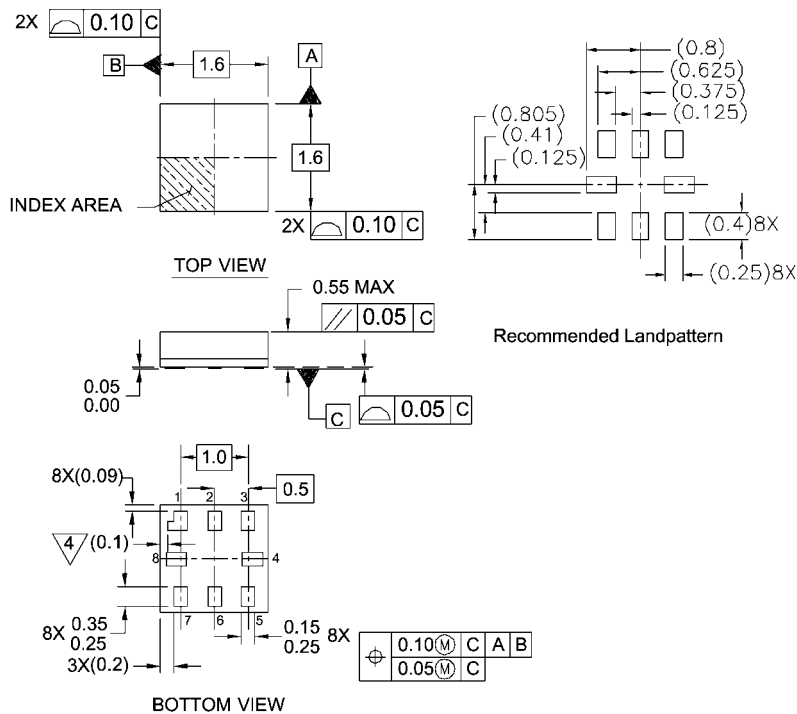

**Notes:**

1. PACKAGE CONFORMS TO JEDEC MO-255 VARIATION UAAD
2. DIMENSIONS ARE IN MILLIMETERS
3. DRAWING CONFORMS TO ASME Y.14M-1994
4. PIN 1 FLAG, END OF PACKAGE OFFSET.

MAC08AREVC

**Pb-Free 8-Lead MicroPak, 1.6 mm Wide  
Package Number MAC08A**

Fairchild does not assume any responsibility for use of any circuitry described, no circuit patent licenses are implied and Fairchild reserves the right at any time without notice to change said circuitry and specifications.

**LIFE SUPPORT POLICY**

FAIRCHILD'S PRODUCTS ARE NOT AUTHORIZED FOR USE AS CRITICAL COMPONENTS IN LIFE SUPPORT DEVICES OR SYSTEMS WITHOUT THE EXPRESS WRITTEN APPROVAL OF THE PRESIDENT OF FAIRCHILD SEMICONDUCTOR CORPORATION. As used herein:

1. Life support devices or systems are devices or systems which, (a) are intended for surgical implant into the body, or (b) support or sustain life, and (c) whose failure to perform when properly used in accordance with instructions for use provided in the labeling, can be reasonably expected to result in a significant injury to the user.
2. A critical component in any component of a life support device or system whose failure to perform can be reasonably expected to cause the failure of the life support device or system, or to affect its safety or effectiveness.

[www.fairchildsemi.com](http://www.fairchildsemi.com)