

# 2SK2925(L),2SK2925(S)

Silicon N Channel MOS FET  
High Speed Power Switching

# HITACHI

ADE-208-549C (Z)  
4th. Edition  
Jun 1998

## Features

- Low on-resistance  
 $R_{DS} = 0.060 \Omega$  typ.
- High speed switching
- 4V gate drive device can be driven from 5V source

## Outline

DPAK-2

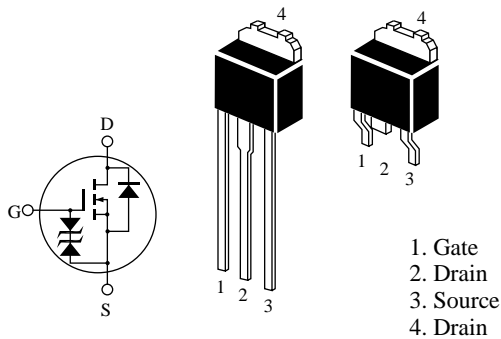

## 2SK2925(L),2SK2925(S)

### Absolute Maximum Ratings (Ta = 25°C)

Item	Symbol	Ratings	Unit
Drain to source voltage	$V_{DSS}$	60	V
Gate to source voltage	$V_{GSS}$	±20	V
Drain current	$I_D$	10	A
Drain peak current	$I_{D(pulse)}$ <sup>Note1</sup>	40	A
Body-drain diode reverse drain current	$I_{DR}$	10	A
Avalanche current	$I_{AP}$ <sup>Note3</sup>	10	A
Avalanche energy	$E_{AR}$ <sup>Note3</sup>	8.5	mJ
Channel dissipation	$P_{ch}$ <sup>Note2</sup>	20	W
Channel temperature	Tch	150	°C
Storage temperature	Tstg	-55 to +150	°C

- Note: 1.  $PW \leq 10\mu s$ , duty cycle  $\leq 1\%$   
2. Value at  $T_c = 25^\circ C$   
3. Value at  $T_{ch} = 25^\circ C$ ,  $R_g \geq 50\Omega$

Electrical Characteristics (Ta = 25°C)

Item	Symbol	Min	Typ	Max	Unit	Test Conditions
Drain to source breakdown voltage	$V_{(BR)DSS}$	60	—	—	V	$I_D = 10\text{mA}, V_{GS} = 0$
Gate to source breakdown voltage	$V_{(BR)GSS}$	$\pm 20$	—	—	V	$I_G = \pm 100\mu\text{A}, V_{DS} = 0$
Gate to source leak current	$I_{GSS}$	—	—	$\pm 10$	$\mu\text{A}$	$V_{GS} = \pm 16\text{V}, V_{DS} = 0$
Zero gate voltage drain current	$I_{DSS}$	—	—	10	$\mu\text{A}$	$V_{DS} = 60\text{V}, V_{GS} = 0$
Gate to source cutoff voltage	$V_{GS(off)}$	1.5	—	2.5	V	$I_D = 1\text{mA}, V_{DS} = 10\text{V}$
Static drain to source on state resistance	$R_{DS(on)}$	—	0.060	0.080	$\Omega$	$I_D = 5\text{A}, V_{GS} = 10\text{V}^{\text{Note4}}$
	$R_{DS(on)}$	—	0.095	0.160	$\Omega$	$I_D = 5\text{A}, V_{GS} = 4\text{V}^{\text{Note4}}$
Forward transfer admittance	$ y_{fs} $	5	8	—	S	$I_D = 5\text{A}, V_{DS} = 10\text{V}^{\text{Note4}}$
Input capacitance	$C_{iss}$	—	350	—	pF	$V_{DS} = 10\text{V}$
Output capacitance	$C_{oss}$	—	190	—	pF	$V_{GS} = 0$
Reverse transfer capacitance	$C_{rss}$	—	70	—	pF	$f = 1\text{MHz}$
Turn-on delay time	$t_{d(on)}$	—	10	—	ns	$I_D = 5\text{A}, V_{GS} = 10\text{V}$
Rise time	$t_r$	—	55	—	ns	$R_L = 6\Omega$
Turn-off delay time	$t_{d(off)}$	—	60	—	ns	
Fall time	$t_f$	—	70	—	ns	
Body-drain diode forward voltage	$V_{DF}$	—	0.9	—	V	$I_F = 10\text{A}, V_{GS} = 0$
Body-drain diode reverse recovery time	$t_{rr}$	—	50	—	ns	$I_F = 10\text{A}, V_{GS} = 0$ $diF/dt = 50\text{A}/\mu\text{s}$

Note: 4. Pulse test

## Main Characteristics

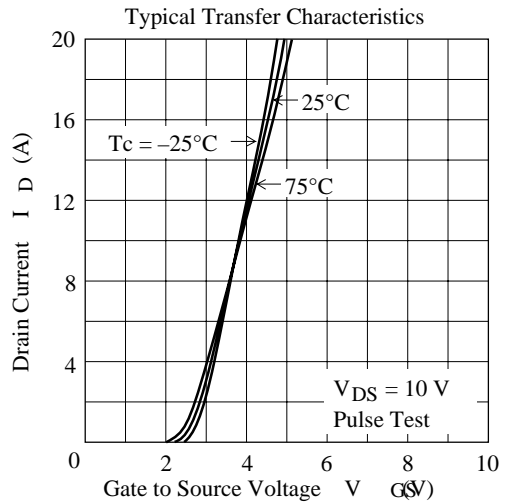
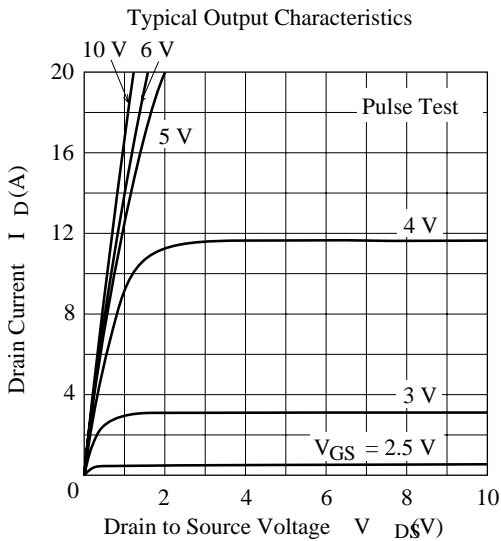
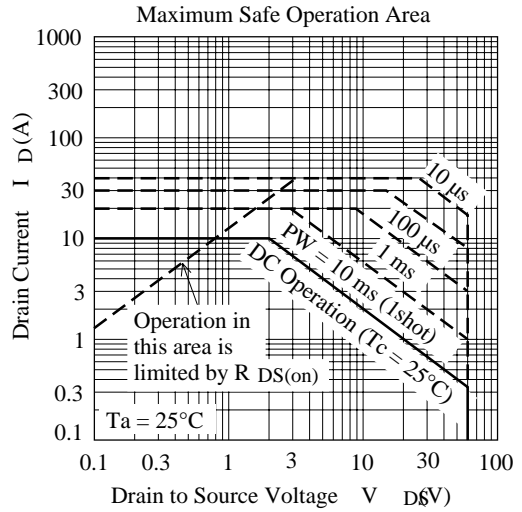
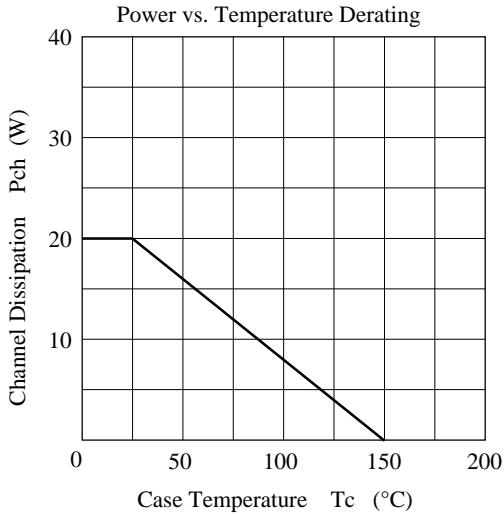

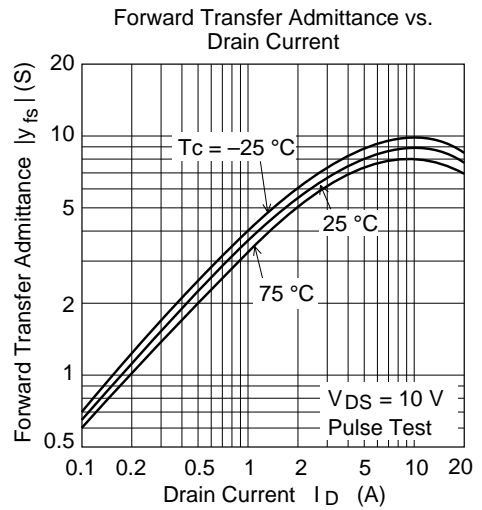
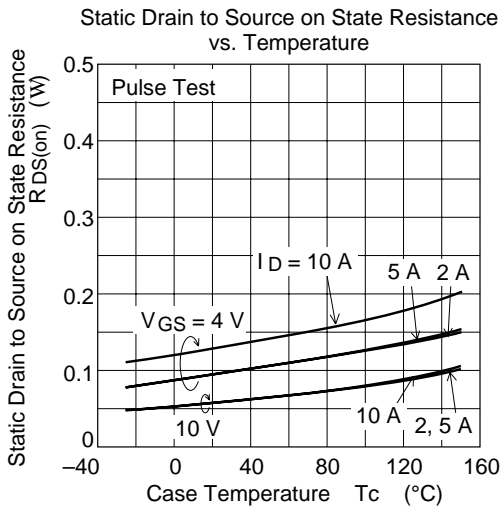
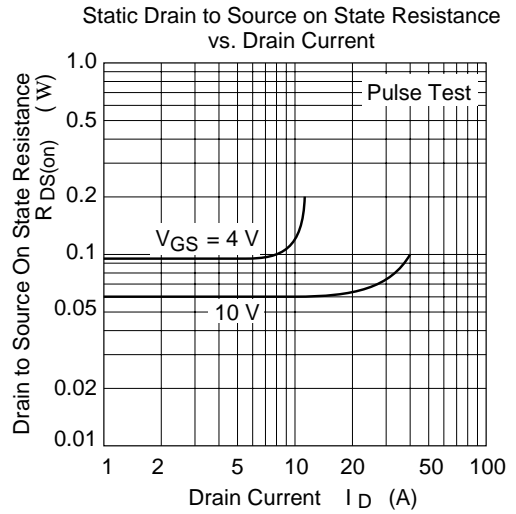
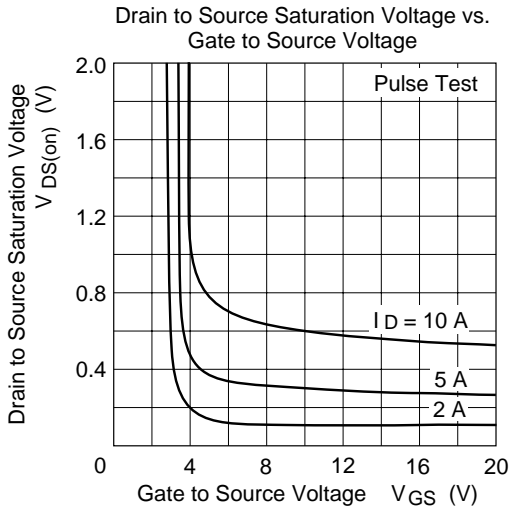

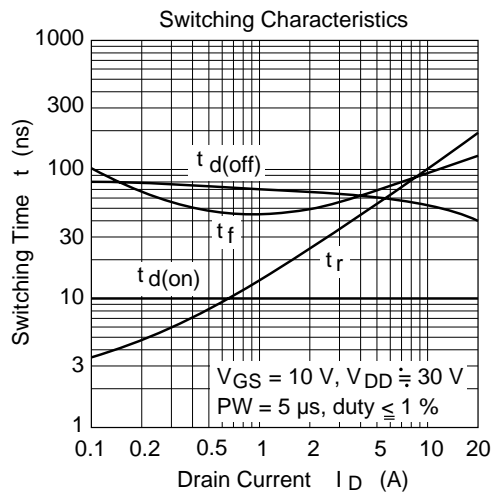
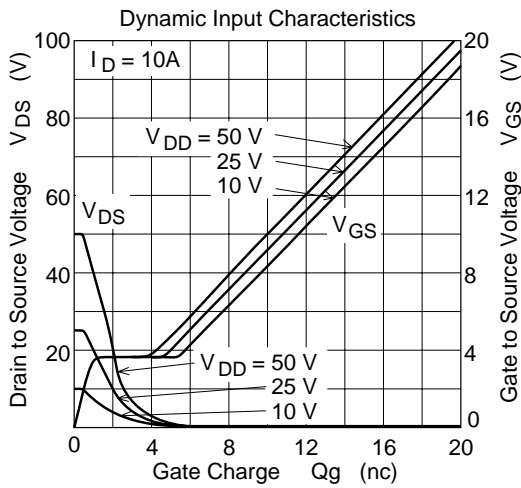
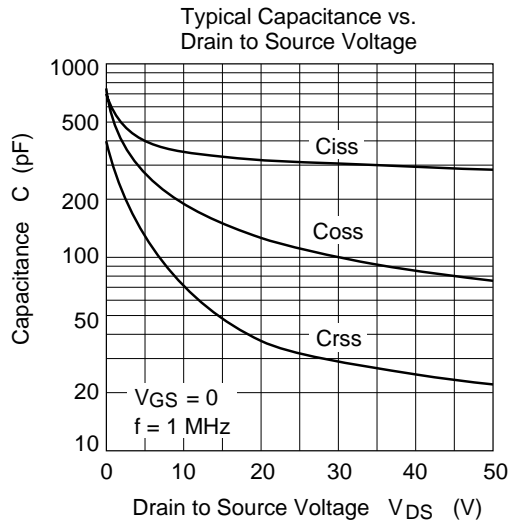
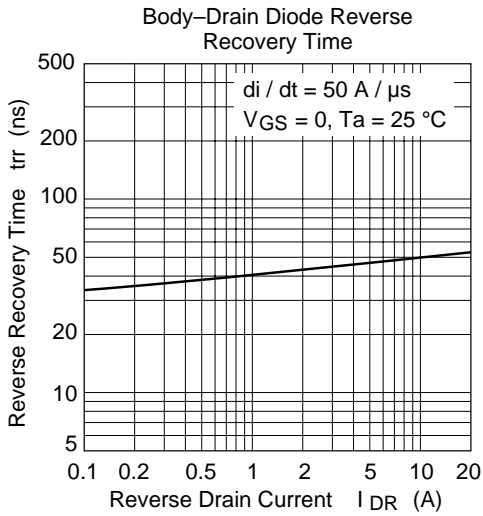

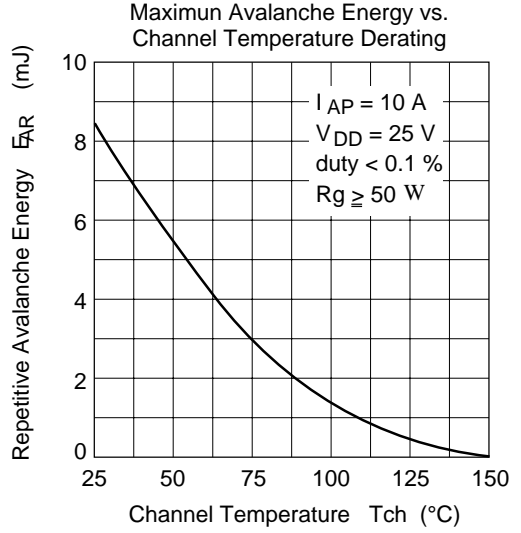
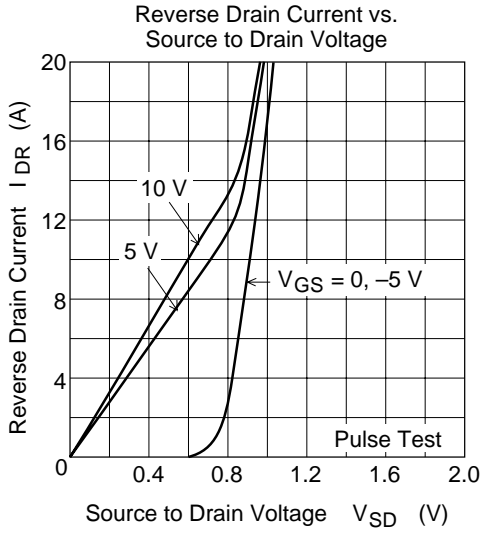

Avalanche Test Circuit

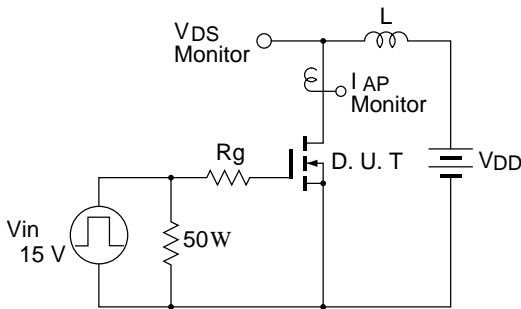

Avalanche Waveform

$$E_{AR} = \frac{1}{2} \cdot L \cdot I_{AP}^2 \cdot \frac{V_{DSS}}{V_{DSS} - V_{DD}}$$

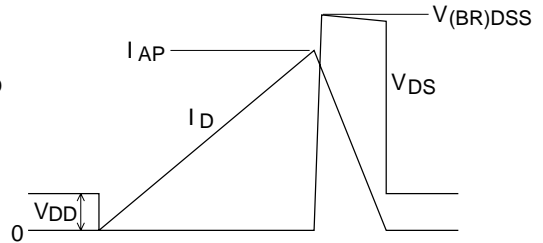

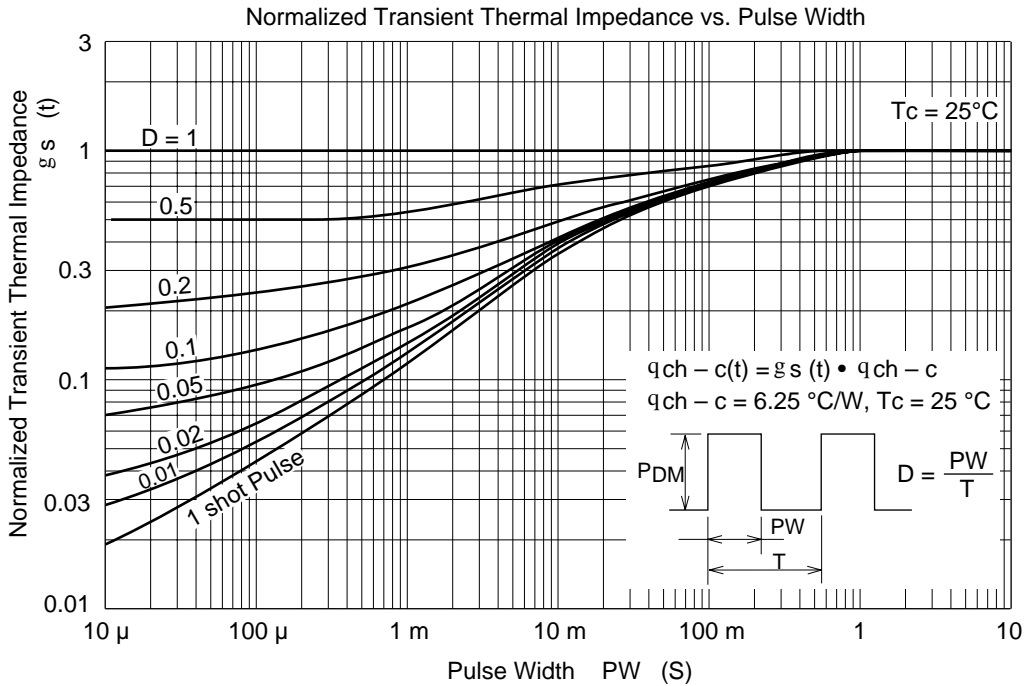

Switching Time Test Circuit

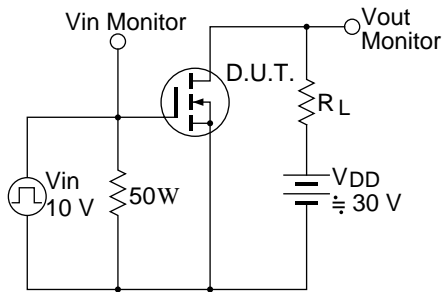

Waveform

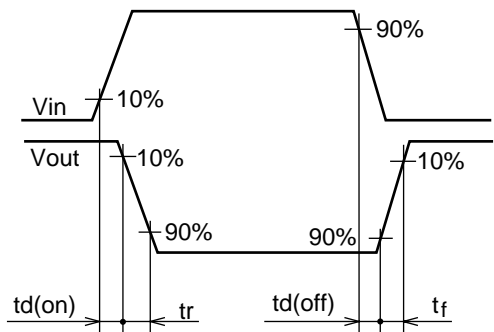



Package Dimensions

Unit: mm

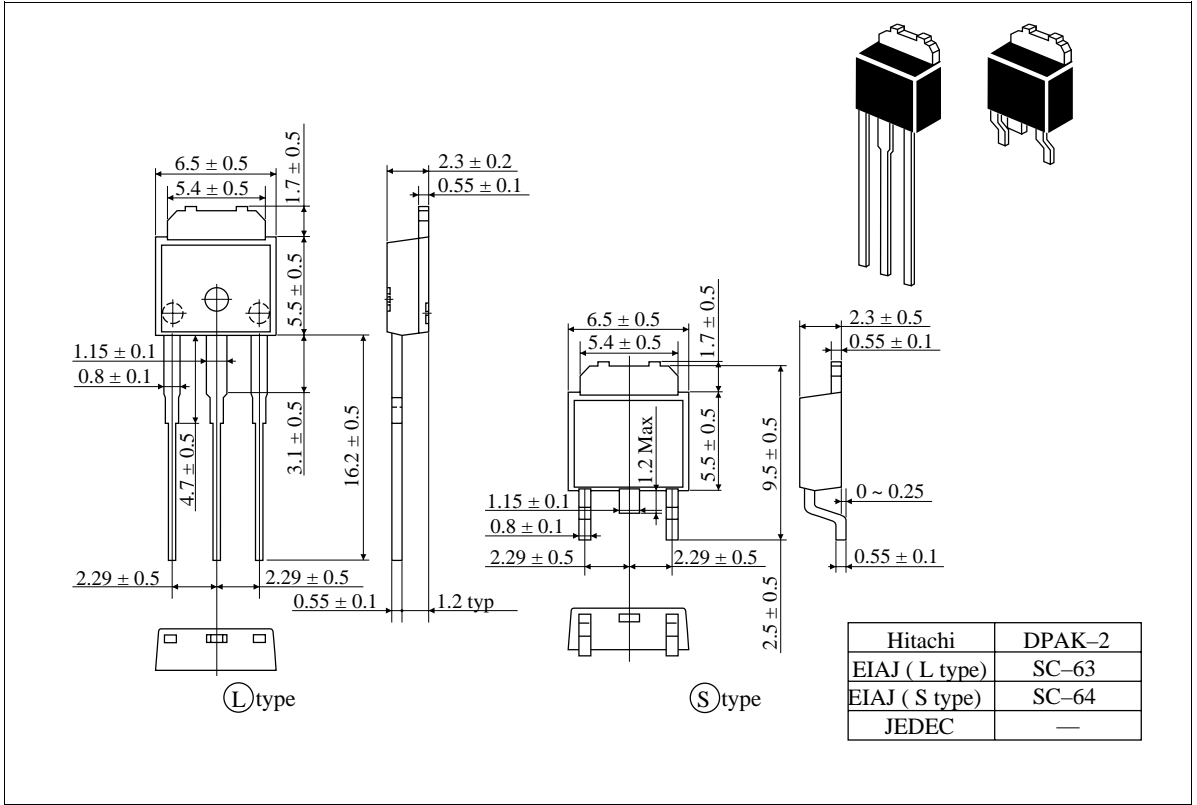

## Cautions

1. Hitachi neither warrants nor grants licenses of any rights of Hitachi's or any third party's patent, copyright, trademark, or other intellectual property rights for information contained in this document. Hitachi bears no responsibility for problems that may arise with third party's rights, including intellectual property rights, in connection with use of the information contained in this document.
2. Products and product specifications may be subject to change without notice. Confirm that you have received the latest product standards or specifications before final design, purchase or use.
3. Hitachi makes every attempt to ensure that its products are of high quality and reliability. However, contact Hitachi's sales office before using the product in an application that demands especially high quality and reliability or where its failure or malfunction may directly threaten human life or cause risk of bodily injury, such as aerospace, aeronautics, nuclear power, combustion control, transportation, traffic, safety equipment or medical equipment for life support.
4. Design your application so that the product is used within the ranges guaranteed by Hitachi particularly for maximum rating, operating supply voltage range, heat radiation characteristics, installation conditions and other characteristics. Hitachi bears no responsibility for failure or damage when used beyond the guaranteed ranges. Even within the guaranteed ranges, consider normally foreseeable failure rates or failure modes in semiconductor devices and employ systemic measures such as fail-safes, so that the equipment incorporating Hitachi product does not cause bodily injury, fire or other consequential damage due to operation of the Hitachi product.
5. This product is not designed to be radiation resistant.
6. No one is permitted to reproduce or duplicate, in any form, the whole or part of this document without written approval from Hitachi.
7. Contact Hitachi's sales office for any questions regarding this document or Hitachi semiconductor products.

# HITACHI

## Hitachi, Ltd.

Semiconductor & Integrated Circuits.  
Nippon Bldg., 2-6-2, Ohte-machi, Chiyoda-ku, Tokyo 100-0004, Japan  
Tel: Tokyo (03) 3270-2111 Fax: (03) 3270-5109

URL      North America      : <http://semiconductor.hitachi.com/>  
             Europe                : <http://www.hitachi-eu.com/hel/ecg>  
             Asia (Singapore)      : <http://www.has.hitachi.com.sg/grp3/sicd/index.htm>  
             Asia (Taiwan)            : [http://www.hitachi.com.tw/E/Product/SICD\\_Frame.htm](http://www.hitachi.com.tw/E/Product/SICD_Frame.htm)  
             Asia (HongKong)        : <http://www.hitachi.com.hk/eng/bo/grp3/index.htm>  
             Japan                        : <http://www.hitachi.co.jp/Sicd/indx.htm>

## For further information write to:

Hitachi Semiconductor  
(America) Inc.  
179 East Tasman Drive,  
San Jose, CA 95134  
Tel: <1> (408) 433-1990  
Fax: <1> (408) 433-0223

Hitachi Europe GmbH  
Electronic components Group  
Dornacher Straße 3  
D-85622 Feldkirchen, Munich  
Germany  
Tel: <49> (89) 9 9180-0  
Fax: <49> (89) 9 29 30 00

Hitachi Europe Ltd.  
Electronic Components Group.  
Whitebrook Park  
Lower Cookham Road  
Maidenhead  
Berkshire SL6 8YA, United Kingdom  
Tel: <44> (1628) 585000  
Fax: <44> (1628) 778322

Hitachi Asia Pte. Ltd.  
16 Collyer Quay #20-00  
Hitachi Tower  
Singapore 049318  
Tel: 535-2100  
Fax: 535-1533

Hitachi Asia Ltd.  
Taipei Branch Office  
3F, Hung Kuo Building, No.167,  
Tun-Hwa North Road, Taipei (105)  
Tel: <886> (2) 2718-3666  
Fax: <886> (2) 2718-8180

Hitachi Asia (Hong Kong) Ltd.  
Group III (Electronic Components)  
7/F., North Tower, World Finance Centre,  
Harbour City, Canton Road, Tsim Sha Tsui,  
Kowloon, Hong Kong  
Tel: <852> (2) 735 9218  
Fax: <852> (2) 730 0281  
Telex: 40815 HITEC HX

Copyright ' Hitachi, Ltd., 1999. All rights reserved. Printed in Japan.

**HITACHI**