

PRELIMINARY DATA SHEET

NEC

NPN SILICON EPITAXIAL TWIN TRANSISTOR

UPA836TF

FEATURES

- **LOW NOISE:**
Q1: NF = 1.5 dB TYP at f = 2 GHz, VCE = 3 V, Ic = 3 mA
Q2: NF = 1.7 dB TYP at f = 2 GHz, VCE = 1 V, Ic = 3 mA
- **HIGH GAIN:**
Q1: $|S_{21E}|^2 = 8.5$ dB TYP at f = 2 GHz, VCE = 3 V, Ic = 10 mA
Q2: $|S_{21E}|^2 = 3.5$ dB TYP at f = 2 GHz, VCE = 1 V, Ic = 3 mA
- **6-PIN THIN-TYPE SMALL MINI MOLD PACKAGE**
- **2 DIFFERENT BUILT-IN TRANSISTORS**
(Q1: NE685, Q2: NE688)

DESCRIPTION

The UPA836TF has two different built-in transistors for low cost amplifier and oscillator applications up to L and S band. Low noise figures, high gain, high current capability, and medium output give this device high dynamic range and excellent linearity for two-stage amplifiers. This device is also ideally suited for use in a VCO/buffer amplifier application. The thinner package style allows for higher density designs.

OUTLINE DIMENSIONS (Units in mm)

Package Outline TS06 (Top View)

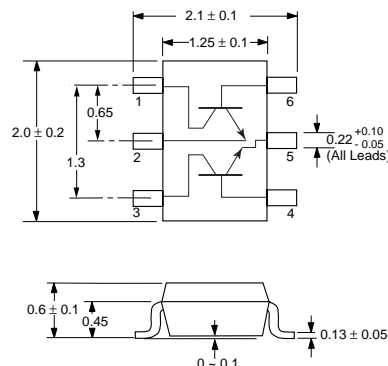

PIN CONNECTIONS

1. Collector (Q1)
2. Emitter (Q1)
3. Collector (Q2)
4. Base (Q2)
5. Emitter (Q2)
6. Base (Q1)

Note:

Pin 1 is the lower left most pin as the package lettering is oriented and read left to right.

ELECTRICAL CHARACTERISTICS (TA = 25°C)

PART NUMBER PACKAGE OUTLINE				UPA836TF TS06		
	SYMBOLS	PARAMETERS AND CONDITIONS	UNITS	MIN	TYP	MAX
Q1	ICBO	Collector Cutoff Current at VCB = 5 V, IE = 0	μA			0.1
	IEBO	Emitter Cutoff Current at VEB = 1 V, Ic = 0	μA			0.1
	hFE	DC Current Gain ¹ at VCE = 3 V, Ic = 10 mA		75		150
	ft	Gain Bandwidth at VCE = 3 V, Ic = 10 mA, f = 2 GHz	GHz		12	
	Cre	Feedback Capacitance ² at VCB = 3 V, IE = 0, f = 1 MHz	pF		0.4	0.7
	$ S_{21E} ^2$	Insertion Power Gain at VCE = 3 V, Ic = 10 mA, f = 2 GHz	dB	7	8.5	
	NF	Noise Figure at VCE = 3 V, Ic = 3 mA, f = 2 GHz	dB		1.5	2.5
Q2	ICBO	Collector Cutoff Current at VCB = 5 V, IE = 0	μA			0.1
	IEBO	Emitter Cutoff Current at VEB = 1 V, Ic = 0	μA			0.1
	hFE	DC Current Gain ¹ at VCE = 1 V, Ic = 3 mA		100		145
	ft	Gain Bandwidth (1) at VCE = 1 V, Ic = 3 mA, f = 2 GHz	GHz	4.0	4.5	
	ft	Gain Bandwidth (2) at VCE = 3 V, Ic = 20 mA, f = 2 GHz	GHz		9.0	
	Cre	Feedback Capacitance ² at VCB = 1 V, IE = 0, f = 1 MHz	pF		0.75	0.85
	$ S_{21E} ^2$	Insertion Power Gain (1) at VCE = 1 V, Ic = 3 mA, f = 2 GHz	dB	2.5	3.5	
	$ S_{21E} ^2$	Insertion Power Gain (2) at VCE = 3 V, Ic = 20 mA, f = 2 GHz	dB		6.5	
	NF	Noise Figure (1) at VCE = 1 V, Ic = 3 mA, f = 2 GHz	dB		1.7	2.5
NF	Noise Figure (2) at VCE = 3 V, Ic = 7 mA, f = 2 GHz	dB		1.5		

Notes: 1. Pulsed measurement, pulse width ≤ 350 μs, duty cycle ≤ 2 %.
2. Collector to base capacitance when measured with capacitance meter (automatic balanced bridge method), with emitter connected to guard pin of capacitance meter.

ABSOLUTE MAXIMUM RATINGS¹ (T_A = 25°C)

SYMBOLS	PARAMETERS	UNITS	RATINGS	
			Q1	Q2
V _{CB0}	Collector to Base Voltage	V	9	9
V _{CE0}	Collector to Emitter Voltage	V	6	6
V _{EB0}	Emitter to Base Voltage	V	2	2
I _c	Collector Current	mA	30	100
P _T	Total Power Dissipation	mW	150	150
			200 ²	
T _J	Junction Temperature	°C	150	150
T _{STG}	Storage Temperature	°C	-65 to +150	

Note: 1. Operation in excess of any one of these parameters may result in permanent damage.
 2. When operating both devices, the power dissipation for either device should not exceed 110 mW.

TYPICAL PERFORMANCE CURVES (T_A = 25°C)

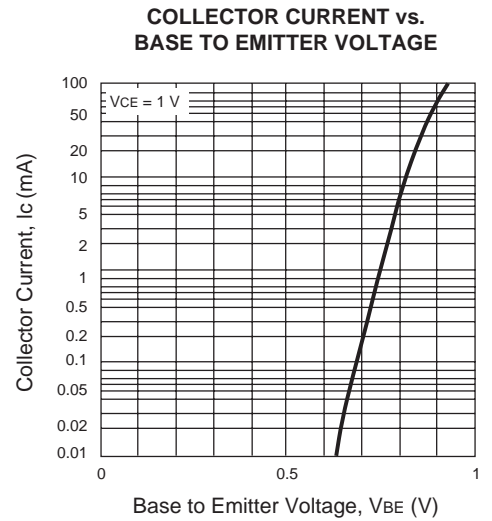
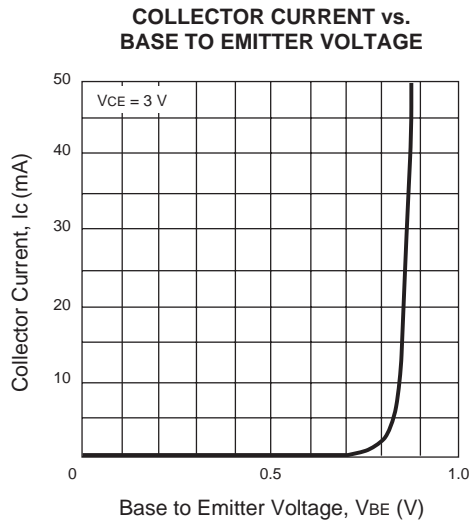
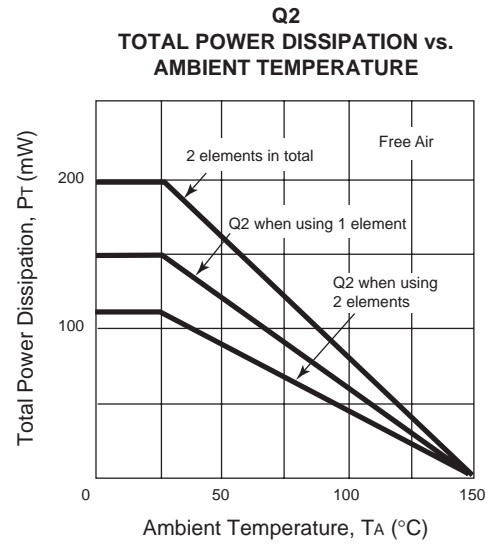
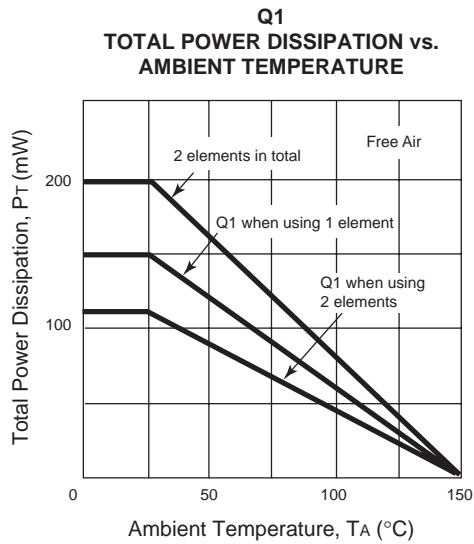

TYPICAL PERFORMANCE CURVES ($T_A = 25^\circ\text{C}$)

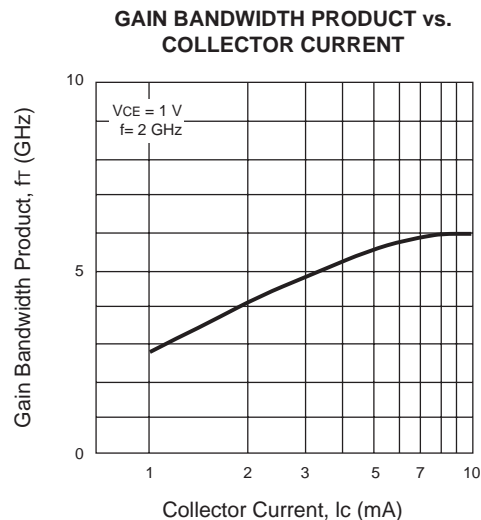
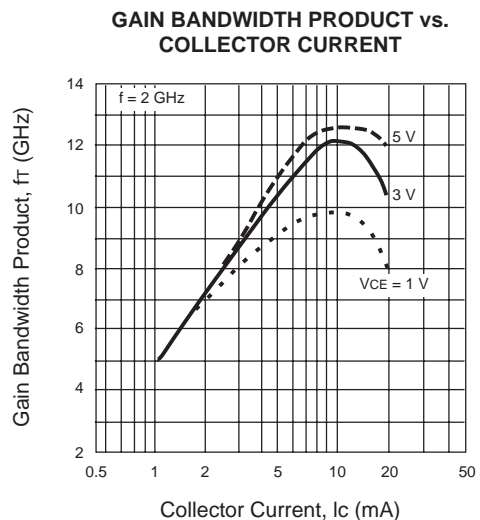
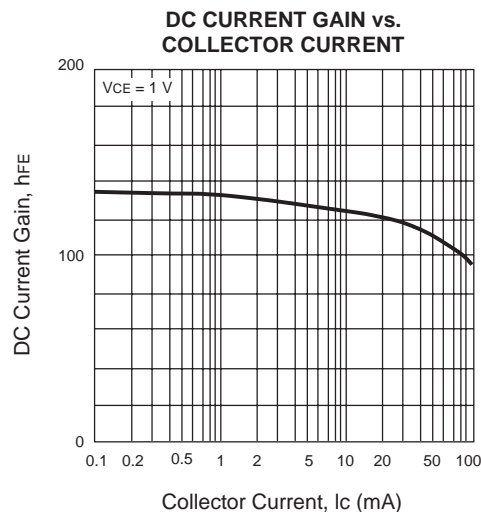
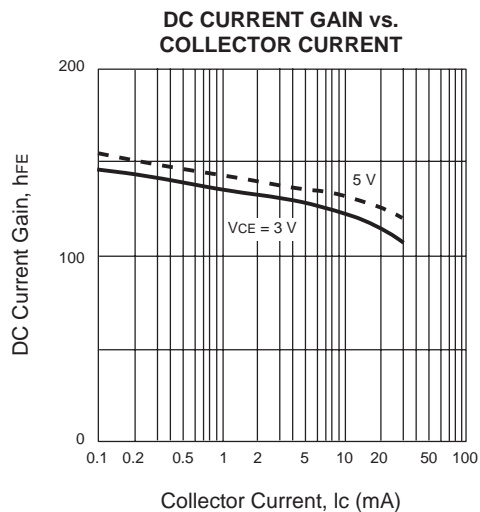
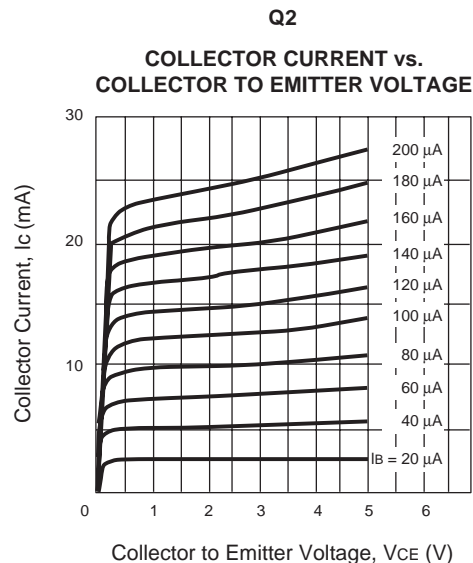
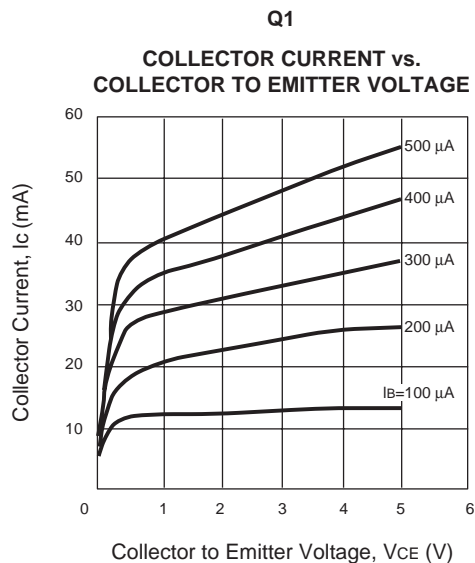

TYPICAL PERFORMANCE CURVES (T_A = 25°C)

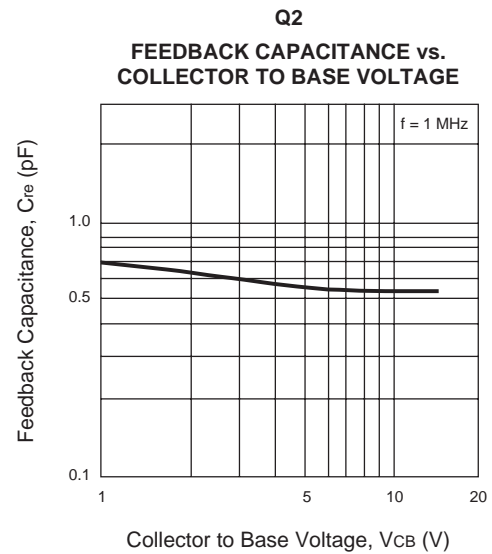
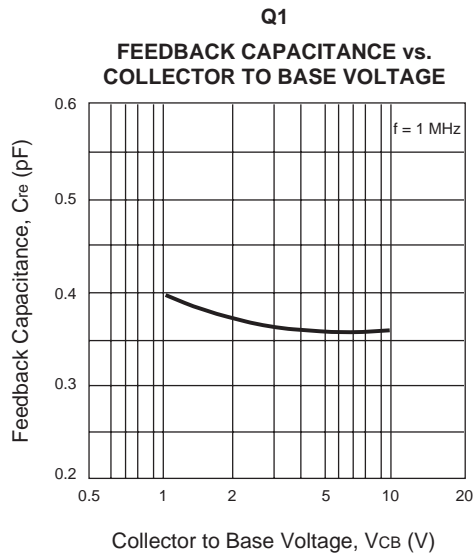
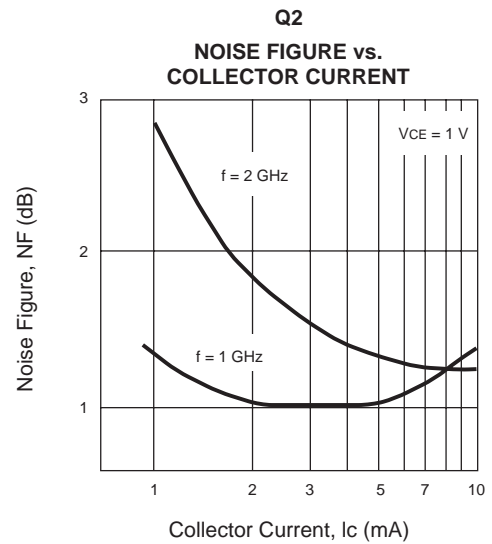
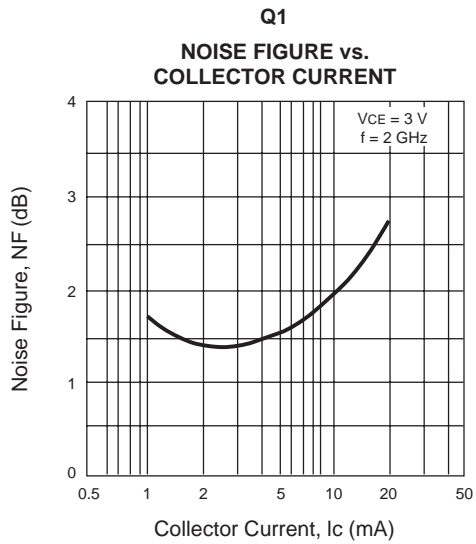
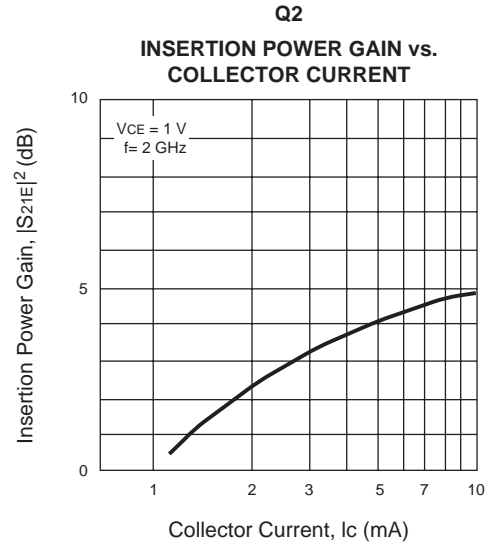
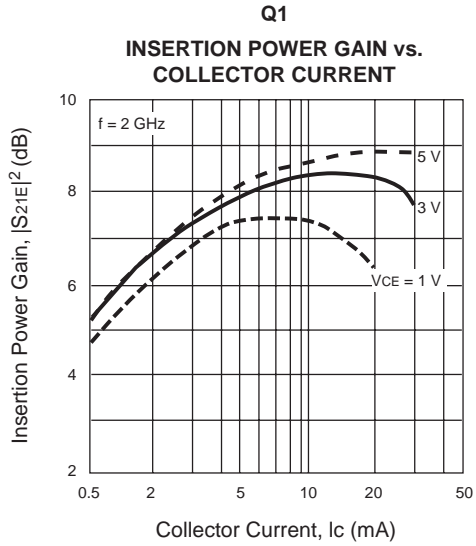

TYPICAL PERFORMANCE CURVES ($T_A = 25^\circ\text{C}$)

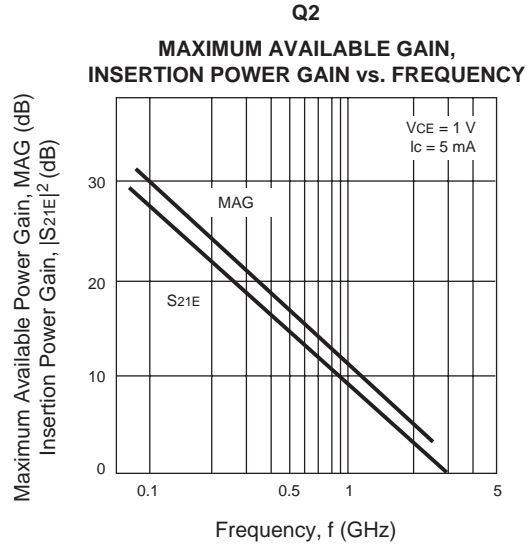
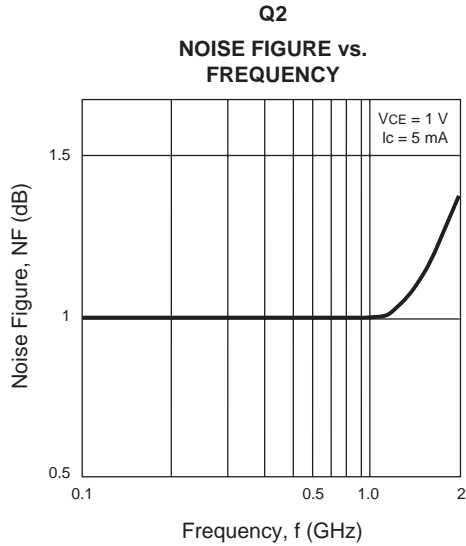

TYPICAL SCATTERING PARAMETERS

Q1

VCE = 3 V, Ic = 1 mA, Z0 = 50 Ω

FREQUENCY (GHz)	S11		S21		S12		S22	
	MAG	ANG	MAG	ANG	MAG	ANG	MAG	ANG
0.10	0.98	-5.93	2.38	172.32	0.02	85.76	1.00	-3.86
0.20	0.97	-11.90	2.36	165.08	0.04	81.15	0.99	-7.44
0.30	0.95	-18.17	2.39	158.35	0.06	76.27	0.97	-11.14
0.40	0.93	-24.00	2.35	151.83	0.07	72.22	0.96	-14.73
0.50	0.90	-30.10	2.35	145.70	0.09	68.30	0.94	-18.02
0.60	0.87	-36.17	2.33	140.22	0.10	64.18	0.92	-21.42
0.70	0.84	-42.49	2.30	134.45	0.12	60.68	0.89	-24.18
0.80	0.80	-48.69	2.29	129.32	0.13	56.90	0.87	-27.47
0.90	0.76	-55.28	2.29	123.53	0.14	53.94	0.84	-29.94
1.00	0.73	-61.26	2.24	118.31	0.15	51.07	0.81	-32.50
1.20	0.64	-74.79	2.19	108.30	0.16	45.85	0.76	-36.89
1.50	0.51	-96.77	2.10	93.80	0.18	39.24	0.69	-42.90
1.70	0.43	-112.09	2.00	84.74	0.19	36.24	0.65	-46.39
2.00	0.35	-138.38	1.84	72.75	0.19	32.40	0.60	-51.51
2.50	0.31	175.03	1.62	54.64	0.20	29.55	0.53	-59.91
3.00	0.35	140.64	1.41	40.02	0.21	28.96	0.47	-69.74

Q2

VCE = 3 V, Ic = 1 mA, Z0 = 50 Ω

FREQUENCY (GHz)	S11		S21		S12		S22	
	MAG	ANG	MAG	ANG	MAG	ANG	MAG	ANG
0.10	0.97	-14.32	2.42	166.29	0.04	80.18	0.99	-7.24
0.20	0.95	-28.41	2.36	154.31	0.07	70.77	0.96	-14.16
0.30	0.91	-42.45	2.34	143.61	0.10	62.19	0.91	-20.19
0.40	0.88	-55.88	2.25	133.74	0.13	54.42	0.87	-25.69
0.50	0.83	-69.17	2.21	124.69	0.14	48.08	0.81	-30.13
0.60	0.79	-81.80	2.14	116.51	0.16	42.00	0.77	-34.32
0.70	0.75	-93.67	2.06	108.52	0.17	37.41	0.72	-37.52
0.80	0.72	-104.67	1.98	101.49	0.17	33.30	0.68	-40.84
0.90	0.69	-115.37	1.91	94.57	0.18	29.92	0.65	-43.52
1.00	0.67	-124.80	1.81	88.40	0.18	27.31	0.62	-46.09
1.20	0.63	-142.25	1.66	77.30	0.18	23.77	0.57	-51.18
1.50	0.61	-163.80	1.46	63.16	0.17	22.24	0.51	-59.93
1.70	0.61	-175.60	1.35	54.92	0.16	24.02	0.48	-66.60
2.00	0.61	169.35	1.21	43.93	0.16	30.08	0.44	-78.77
2.50	0.64	149.69	1.02	28.22	0.19	41.91	0.39	-106.64
3.00	0.68	134.75	0.88	15.55	0.26	45.51	0.39	-141.18

TYPICAL SCATTERING PARAMETERS

Q1

VCE = 3 V, Ic = 3 mA, Z0 = 50 Ω

FREQUENCY (GHz)	S11		S21		S12		S22	
	MAG	ANG	MAG	ANG	MAG	ANG	MAG	ANG
0.10	0.94	-9.29	6.55	168.08	0.02	84.10	0.98	-6.91
0.20	0.90	-18.39	6.32	157.85	0.04	76.93	0.95	-13.21
0.30	0.85	-27.47	6.21	148.76	0.05	71.79	0.91	-18.80
0.40	0.80	-36.15	5.98	140.53	0.06	66.81	0.86	-23.80
0.50	0.74	-44.62	5.77	133.00	0.07	63.60	0.81	-27.41
0.60	0.67	-52.69	5.51	126.23	0.08	60.13	0.76	-31.19
0.70	0.60	-60.71	5.28	119.27	0.09	58.07	0.72	-33.67
0.80	0.54	-68.45	5.03	113.12	0.10	55.93	0.68	-36.31
0.90	0.47	-75.60	4.76	107.23	0.11	54.62	0.64	-38.10
1.00	0.42	-82.57	4.50	101.99	0.11	53.45	0.61	-39.74
1.20	0.32	-96.78	4.02	92.52	0.13	51.59	0.56	-42.63
1.50	0.21	-122.39	3.42	80.83	0.15	49.61	0.50	-46.74
1.70	0.17	-143.90	3.10	74.15	0.16	48.63	0.46	-49.50
2.00	0.16	179.12	2.70	64.83	0.18	46.70	0.42	-54.02
2.50	0.22	136.13	2.24	51.62	0.21	43.76	0.36	-63.34
3.00	0.29	115.80	1.89	39.81	0.23	40.27	0.31	-75.36

Q2

VCE = 3 V, Ic = 3 mA, Z0 = 50 Ω

FREQUENCY (GHz)	S11		S21		S12		S22	
	MAG	ANG	MAG	ANG	MAG	ANG	MAG	ANG
0.10	0.91	-20.77	6.78	160.00	0.04	76.08	0.95	-14.28
0.20	0.84	-40.45	6.30	145.15	0.06	64.72	0.86	-26.08
0.30	0.76	-59.61	5.98	132.53	0.08	56.56	0.75	-34.42
0.40	0.69	-77.35	5.54	121.70	0.10	50.58	0.66	-41.09
0.50	0.62	-93.52	5.09	112.12	0.11	47.02	0.58	-45.13
0.60	0.57	-107.23	4.61	114.36	0.12	44.57	0.51	-48.78
0.70	0.53	-119.29	4.20	97.25	0.12	43.10	0.46	-51.09
0.80	0.50	-129.99	3.84	91.32	0.13	42.46	0.42	-53.42
0.90	0.48	-139.30	3.51	85.88	0.13	41.93	0.38	-55.21
1.00	0.47	-147.65	3.25	80.98	0.14	42.00	0.36	-56.92
1.20	0.46	-161.91	2.80	72.45	0.15	42.33	0.31	-60.52
1.50	0.46	-179.07	2.33	61.22	0.17	43.12	0.25	-67.97
1.70	0.47	171.72	2.10	54.61	0.18	43.54	0.21	-74.72
2.00	0.49	160.12	1.83	45.19	0.21	44.70	0.17	-89.34
2.50	0.54	144.71	1.52	31.01	0.25	42.00	0.13	-132.57
3.00	0.59	132.90	1.29	18.97	0.30	38.08	0.17	-179.42

TYPICAL SCATTERING PARAMETERS

Q1

VCE = 3 V, IC = 5 mA, Z0 = 50 Ω

FREQUENCY (GHz)	S11		S21		S12		S22	
	MAG	ANG	MAG	ANG	MAG	ANG	MAG	ANG
0.10	0.90	-12.12	10.05	165.07	0.02	82.08	0.97	-9.12
0.20	0.84	-23.51	9.49	152.86	0.03	74.99	0.92	-17.06
0.30	0.77	-34.84	9.08	142.06	0.05	69.42	0.85	-23.23
0.40	0.69	-45.03	8.52	132.57	0.06	65.57	0.78	-28.22
0.50	0.60	-54.58	7.94	123.96	0.07	63.02	0.72	-31.57
0.60	0.52	-62.89	7.32	116.79	0.08	60.80	0.66	-34.45
0.70	0.44	-70.48	6.74	109.99	0.08	59.78	0.62	-36.34
0.80	0.38	-77.63	6.21	104.22	0.09	58.73	0.58	-38.08
0.90	0.32	-84.12	5.71	99.08	0.10	57.98	0.55	-39.38
1.00	0.28	-90.92	5.28	94.41	0.11	57.45	0.53	-40.58
1.20	0.20	-105.44	4.56	86.53	0.12	56.41	0.48	-42.73
1.50	0.13	-137.90	3.78	76.56	0.14	54.85	0.43	-46.37
1.70	0.11	-167.88	3.39	70.79	0.15	53.69	0.40	-49.23
2.00	0.13	152.80	2.93	62.58	0.18	51.42	0.37	-54.00
2.50	0.21	121.76	2.41	50.64	0.21	47.56	0.31	-64.32
3.00	0.28	107.74	2.03	39.80	0.24	42.91	0.26	-78.22

Q2

VCE = 3 V, IC = 5 mA, Z0 = 50 Ω

FREQUENCY (GHz)	S11		S21		S12		S22	
	MAG	ANG	MAG	ANG	MAG	ANG	MAG	ANG
0.10	0.84	-26.28	10.60	155.28	0.03	73.62	0.91	-19.87
0.20	0.75	-50.58	9.48	138.37	0.06	62.12	0.77	-34.36
0.30	0.64	-73.48	8.58	124.39	0.07	55.68	0.63	-43.20
0.40	0.56	-93.24	7.56	113.09	0.08	52.30	0.53	-49.31
0.50	0.49	-109.26	6.59	104.26	0.09	50.89	0.45	-52.83
0.60	0.45	-122.23	5.76	97.42	0.10	50.06	0.39	-55.78
0.70	0.43	-133.23	5.10	91.52	0.11	49.97	0.34	-57.54
0.80	0.41	-142.94	4.57	86.44	0.12	50.11	0.31	-59.42
0.90	0.40	-151.05	4.13	81.93	0.13	50.05	0.27	-60.94
1.00	0.40	-158.37	3.78	77.69	0.13	50.37	0.25	-62.43
1.20	0.40	-170.84	3.22	70.16	0.15	50.44	0.20	-66.17
1.50	0.41	174.38	2.64	60.16	0.18	49.56	0.15	-75.30
1.70	0.43	166.51	2.37	54.26	0.20	48.51	0.12	-85.04
2.00	0.45	156.30	2.05	45.69	0.23	46.68	0.08	-111.15
2.50	0.51	142.45	1.69	32.37	0.28	41.96	0.09	-179.51
3.00	0.56	131.71	1.44	20.88	0.32	36.35	0.17	146.82

TYPICAL SCATTERING PARAMETERS

Q1

VCE = 3 V, IC = 10 mA, Z0 = 50 Ω

FREQUENCY (GHz)	S11		S21		S12		S22	
	MAG	ANG	MAG	ANG	MAG	ANG	MAG	ANG
0.10	0.82	-17.52	16.52	159.99	0.02	80.28	0.94	-12.68
0.20	0.72	-33.22	14.93	144.21	0.03	72.82	0.85	-22.43
0.30	0.60	-46.83	13.32	131.03	0.04	68.07	0.75	-28.43
0.40	0.49	-57.62	11.65	120.45	0.05	65.62	0.67	-32.14
0.50	0.40	-65.90	10.15	112.22	0.06	65.03	0.60	-34.25
0.60	0.33	-72.93	8.90	105.22	0.07	63.86	0.56	-35.78
0.70	0.27	-79.33	7.89	100.37	0.08	63.74	0.52	-36.80
0.80	0.22	-85.38	7.07	95.73	0.08	63.50	0.49	-37.69
0.90	0.18	-91.73	6.39	91.61	0.09	63.16	0.46	-38.46
1.00	0.15	-98.81	5.83	87.88	0.10	62.77	0.45	-39.30
1.20	0.10	-118.22	4.95	81.32	0.11	61.85	0.41	-41.01
1.50	0.07	-176.19	4.05	72.83	0.14	59.79	0.38	-44.69
1.70	0.08	149.79	3.61	67.81	0.15	58.31	0.35	-47.69
2.00	0.13	125.94	3.12	60.46	0.18	55.55	0.32	-53.15
2.50	0.21	109.57	2.54	49.58	0.22	50.37	0.27	-65.07
3.00	0.29	100.79	2.14	39.46	0.25	45.03	0.21	-81.46

Q2

VCE = 3 V, IC = 10 mA, Z0 = 50 Ω

FREQUENCY (GHz)	S11		S21		S12		S22	
	MAG	ANG	MAG	ANG	MAG	ANG	MAG	ANG
0.10	0.70	-38.41	18.28	146.82	0.03	69.80	0.82	-29.66
0.20	0.56	-71.49	14.88	126.35	0.05	61.45	0.61	-46.31
0.30	0.45	-97.54	11.94	112.07	0.06	58.70	0.46	-54.40
0.40	0.39	-116.40	9.67	102.58	0.07	58.67	0.37	-59.06
0.50	0.35	-130.54	8.00	95.72	0.08	59.11	0.30	-61.94
0.60	0.34	-141.64	6.81	90.48	0.09	59.40	0.26	-64.34
0.70	0.33	-150.51	5.91	85.85	0.10	59.73	0.22	-65.99
0.80	0.33	-158.31	5.24	81.79	0.11	59.53	0.19	-68.05
0.90	0.33	-164.94	4.70	78.04	0.12	59.10	0.16	-70.00
1.00	0.33	-170.77	4.27	74.52	0.14	58.94	0.14	-72.05
1.20	0.34	179.29	3.60	68.08	0.16	57.53	0.11	-78.53
1.50	0.37	167.43	2.93	59.24	0.19	54.68	0.06	-101.03
1.70	0.39	160.78	2.62	53.77	0.21	52.45	0.05	-135.60
2.00	0.42	152.28	2.26	45.88	0.25	48.84	0.06	168.53
2.50	0.48	140.09	1.85	33.78	0.30	41.93	0.14	138.30
3.00	0.54	130.31	1.57	22.81	0.34	34.93	0.22	124.44

TYPICAL SCATTERING PARAMETERS

Q2

VCE = 3 V, IC = 7 mA, Z0 = 50 Ω

FREQUENCY (GHz)	S11		S21		S12		S22	
	MAG	ANG	MAG	ANG	MAG	ANG	MAG	ANG
0.10	0.78	-31.29	13.97	151.51	0.03	71.78	0.87	-24.42
0.20	0.66	-59.66	12.04	132.90	0.05	60.97	0.70	-40.28
0.30	0.54	-84.82	10.35	118.21	0.07	56.44	0.55	-48.33
0.40	0.47	-104.53	8.72	107.56	0.08	55.05	0.45	-54.30
0.50	0.42	-119.83	7.38	99.69	0.09	54.45	0.37	-57.44
0.60	0.39	-132.03	6.34	93.65	0.10	54.56	0.32	-60.00
0.70	0.37	-142.05	5.56	88.39	0.11	54.88	0.28	-61.66
0.80	0.36	-150.83	4.94	83.86	0.11	55.01	0.24	-63.45
0.90	0.36	-158.17	4.45	79.83	0.12	55.07	0.21	-65.04
1.00	0.36	-164.78	4.05	75.94	0.13	55.03	0.19	-66.66
1.20	0.37	-175.89	3.43	69.04	0.15	54.31	0.15	-71.21
1.50	0.39	170.80	2.80	59.72	0.19	52.52	0.10	-83.83
1.70	0.40	163.55	2.51	54.06	0.21	50.73	0.07	-100.27
2.00	0.43	154.21	2.17	45.65	0.24	47.90	0.05	-148.70
2.50	0.49	141.28	1.78	33.14	0.29	41.96	0.11	152.83
3.00	0.55	131.03	1.51	21.87	0.33	35.50	0.19	132.79

Q2

VCE = 3 V, IC = 20 mA, Z0 = 50 Ω

FREQUENCY (GHz)	S11		S21		S12		S22	
	MAG	ANG	MAG	ANG	MAG	ANG	MAG	ANG
0.10	0.51	-57.90	27.75	136.02	0.02	69.14	0.70	-39.87
0.20	0.37	-97.17	19.04	114.46	0.04	64.83	0.46	-56.12
0.30	0.31	-120.97	13.81	103.21	0.05	65.82	0.33	-62.80
0.40	0.29	-137.00	10.72	95.92	0.06	66.30	0.26	-66.88
0.50	0.28	-148.56	8.73	90.60	0.08	66.42	0.21	-69.42
0.60	0.28	-157.11	7.34	86.37	0.09	66.46	0.17	-72.27
0.70	0.28	-164.14	6.36	82.37	0.10	66.07	0.14	-74.72
0.80	0.29	-170.13	5.60	78.94	0.11	65.59	0.12	-78.14
0.90	0.29	-175.24	5.00	75.67	0.13	64.35	0.10	-82.37
1.00	0.30	-179.80	4.54	72.57	0.14	63.61	0.08	-87.43
1.20	0.32	172.24	3.81	66.74	0.16	61.26	0.05	-106.92
1.50	0.34	162.54	3.09	58.59	0.20	57.09	0.04	-169.73
1.70	0.37	156.95	2.75	53.51	0.22	54.21	0.06	160.94
2.00	0.40	149.52	2.37	46.16	0.26	46.16	0.11	140.92
2.50	0.46	138.42	1.94	34.42	0.31	34.42	0.19	127.04
3.00	0.52	129.12	1.63	23.88	0.35	23.88	0.27	117.03

NONLINEAR MODEL

BJT NONLINEAR MODEL PARAMETERS(1)

Parameters	Q1	Q2	Parameters	Q1	Q2
IS	7e-16	3.8e-16	MJC	0.34	0.48
BF	109	135.7	XCJC	0	0.56
NF	1	1	CJS	0	0
VAF	15	28	VJS	0.75	0.75
IKF	0.19	0.6	MJS	0	0
ISE	7.9e-13	3.8e-15	FC	0.5	0.75
NE	2.19	1.49	TF	2e-12	11e-12
BR	1	12.3	XTF	5.2	0.36
NR	1.08	1.1	VTF	4.58	0.65
VAR	12.4	3.5	ITF	0.01	0.61
IKR	Infinity	0.06	PTF	0	50
ISC	0	3.5e-16	TR	1e-9	32e-12
NC	2	1.62	EG	1.11	1.11
RE	1.3	0.4	XTB	0	0
RB	10	6.14	XTI	3	3
RBM	8.34	3.5	KF	0	1.5e-14
IRB	0.009	0.001	AF	1	1.22
RC	10	4.2			
CJE	0.4e-12	0.796e-12			
VJE	0.81	0.71			
MJE	0.5	0.38			
CJC	0.18e-12	0.549e-12			
VJC	0.75	0.65			

(1) Gummel-Poon Model

UNITS

Parameter	Units
time	seconds
capacitance	farads
inductance	henries
resistance	ohms
voltage	volts
current	amps

MODEL RANGE

Frequency: 0.1 to 3.0 GHz
 Bias: $V_{CE} = 0.5 \text{ V to } 5 \text{ V}$, $I_C = 1 \text{ mA to } 10 \text{ mA}$
 Date: 10/98

Note:

This nonlinear model utilized the latest data available. See our Design Parameter Library at www.cel.com for this data.

NONLINEAR MODEL

SCHEMATIC

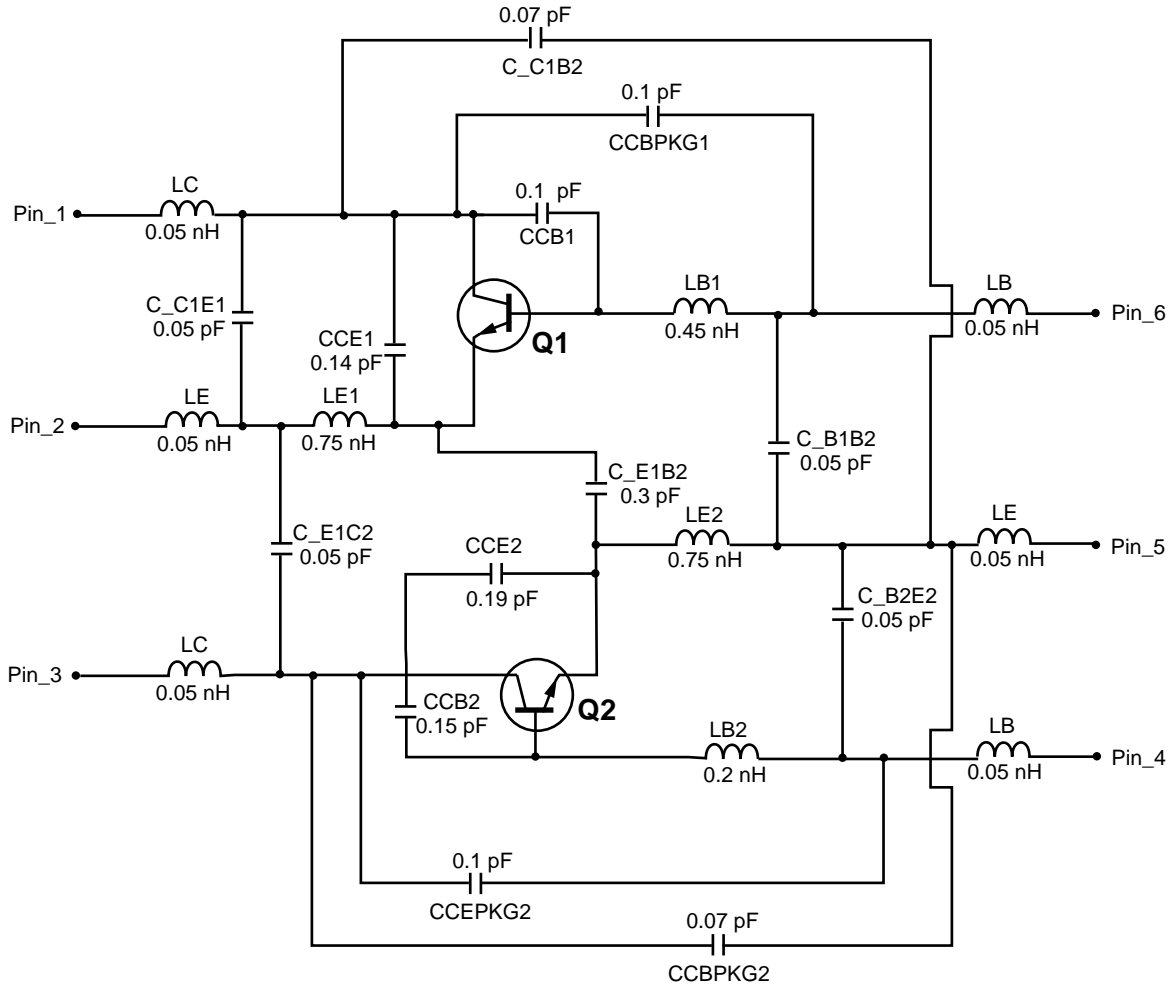

MODEL RANGE

Frequency: 0.1 to 3.0 GHz
 Bias: $V_{CE} = 0.5 \text{ V to } 5 \text{ V}$, $I_c = 1 \text{ mA to } 10 \text{ mA}$
 Date: 10/98

BUILT-IN TRANSISTORS

	Q1	Q2
3-pin small mini mold part No.	NE68530	NE68830

ORDERING INFORMATION

PART NUMBER	QUANTITY	PACKAGING
UPA836TF-T1	3000	Tape & Reel

The UPA833TF features the Q1 and Q2 in inverted positions.

EXCLUSIVE NORTH AMERICAN AGENT FOR **NEC** RF, MICROWAVE & OPTOELECTRONIC SEMICONDUCTORS

CEL CALIFORNIA EASTERN LABORATORIES • Headquarters • 4590 Patrick Henry Drive • Santa Clara, CA 95054-1817 • (408) 988-3500 • Telex 34-6393 • FAX (408) 988-0279
 24-Hour Fax-On-Demand: 800-390-3232 (U.S. and Canada only) • Internet: <http://WWW.CEL.COM>

DATA SUBJECT TO CHANGE WITHOUT NOTICE

PRINTED IN USA ON RECYCLED PAPER -2/99