

TOSHIBA CMOS DIGITAL INTEGRATED CIRCUIT SILICON MONOLITHIC

TC7SH32F, TC7SH32FU

2-INPUT OR GATE

The TC7SH32 is an advanced high speed CMOS 2-INPUT OR GATE fabricated with silicon gate C²MOS technology. It achieves the high speed operation similar to equivalent Bipolar Schottky TTL while maintaining the CMOS low power dissipation. The internal circuit is composed of 4 stages including buffer output, which provide high noise immunity and stable output. An input protection circuit ensures that 0 to 7V can be applied to the input pins without regard to the supply voltage. This device can be used to interface 5V to 3V systems and two supply systems such as battery back up. This circuit prevents device destruction due to mismatched supply and input voltages.

FEATURES

- High Speed $t_{pd} = 3.8ns$ (Typ.) at $V_{CC} = 5V$
- Low Power Dissipation $I_{CC} = 2\mu A$ (Max.) at $T_a = 25^\circ C$
- High Noise Immunity $V_{NIH} = V_{NIL} = 28\% V_{CC}$ (Min.)
- Power Down Protection is provided on all inputs.
- Balanced Propagation Delays $t_{pLH} \approx t_{pHL}$
- Wide Operating Voltage Range $V_{CC(opr)} = 2 \sim 5.5V$

MAXIMUM RATINGS

PARAMETER	SYMBOL	VALUE	UNIT
Supply Voltage Range	V_{CC}	-0.5~7.0	V
DC Input Voltage	V_{IN}	-0.5~7.0	V
DC Output Voltage	V_{OUT}	-0.5~ $V_{CC} + 0.5$	V
Input Diode Current	I_{IK}	-20	mA
Output Diode Current	I_{OK}	±20	mA
DC Output Current	I_{OUT}	±25	mA
DC V_{CC} / Ground Current	I_{CC}	±50	mA
Power Dissipation	P_D	200	mW
Storage Temperature	T_{stg}	-65~150	°C
Lead Temperature (10s)	T_L	260	°C

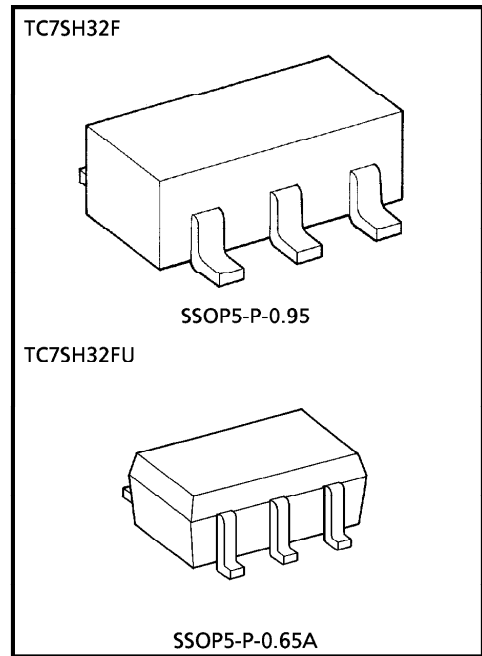

Weight SSOP5-P-0.95 : 0.016g (Typ.)
 SSOP5-P-0.65A : 0.006g (Typ.)

MARKING

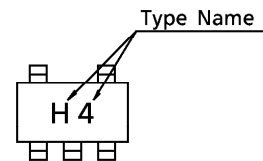

TRUTH TABLE

A	B	Y
H	H	H
L	H	H
H	L	H
L	L	L

961001EBA2

● TOSHIBA is continually working to improve the quality and the reliability of its products. Nevertheless, semiconductor devices in general can malfunction or fail due to their inherent electrical sensitivity and vulnerability to physical stress. It is the responsibility of the buyer, when utilizing TOSHIBA products, to observe standards of safety, and to avoid situations in which a malfunction or failure of a TOSHIBA product could cause loss of human life, bodily injury or damage to property. In developing your designs, please ensure that TOSHIBA products are used within specified operating ranges as set forth in the most recent products specifications. Also, please keep in mind the precautions and conditions set forth in the TOSHIBA Semiconductor Reliability Handbook.

LOGIC DIAGRAM

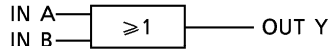

PIN ASSIGNMENT (TOP VIEW)

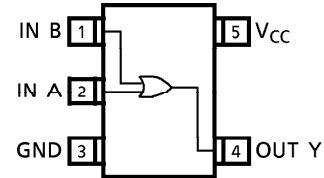

RECOMMENDED OPERATING CONDITIONS

PARAMETER	SYMBOL	VALUE	UNIT
Supply Voltage	V _{CC}	2.0~5.5	V
Input Voltage	V _{IN}	0~5.5	V
Output Voltage	V _{OUT}	0~V _{CC}	V
Operating Temperature	T _{opr}	-40~85	°C
Input Rise and Fall Time	d _t / d _v	0~100 (V _{CC} = 3.3 ± 0.3V)	ns / V
		0~20 (V _{CC} = 5 ± 0.5V)	

DC ELECTRICAL CHARACTERISTICS

PARAMETER	SYMBOL	TEST CIR-CUIT	TEST CONDITION	Ta = 25°C			Ta = -40~85°C		UNIT		
				V _{CC}	MIN.	TYP.	MAX.	MIN.		MAX.	
High-Level Input Voltage	V _{IH}	—	—	2.0 3.0~ 5.5	1.50 V _{CC} × 0.7	— — —	— — —	1.50 V _{CC} × 0.7	V		
Low-Level Input Voltage	V _{IL}	—	—	2.0 3.0~ 5.5	— — —	— — —	— — —	0.50 V _{CC} × 0.3	V		
High Level Output-Voltage	V _{OH}	—	V _{IN} = V _{IH} or V _{IL}	I _{OH} = -50 μA	2.0	1.9	2.0	—	1.9	—	V
					3.0	2.9	3.0	—	2.9	—	
					4.5	4.4	4.5	—	4.4	—	
Low-Level Output-Voltage	V _{OL}	—	V _{IN} = V _{IL}	I _{OL} = 50 μA	2.0	—	0.0	0.1	—	0.1	V
					3.0	—	0.0	0.1	—	0.1	
					4.5	—	0.0	0.1	—	0.1	
Low-Level Output-Voltage	V _{OL}	—	V _{IN} = V _{IL}	I _{OL} = 4mA I _{OL} = 8mA	3.0	—	—	0.36	—	0.44	V
					4.5	—	—	0.36	—	0.44	
					—	—	—	—	—	—	
Input Leakage Current	I _{IN}	—	V _{IN} = 5.5V or GND	0~ 5.5	—	—	± 0.1	—	± 1.0	μA	
Quiescent Supply Current	I _{CC}	—	V _{IN} = V _{CC} or GND	5.5	—	—	2.0	—	20.0		

961001EBA2'

- The products described in this document are subject to foreign exchange and foreign trade control laws.
- The information contained herein is presented only as a guide for the applications of our products. No responsibility is assumed by TOSHIBA CORPORATION for any infringements of intellectual property or other rights of the third parties which may result from its use. No license is granted by implication or otherwise under any intellectual property or other rights of TOSHIBA CORPORATION or others.
- The information contained herein is subject to change without notice.

AC ELECTRICAL CHARACTERISTICS (Input $t_r = t_f = 3\text{ns}$)

PARAMETER	SYMBOL	TEST CIR-CUIT	TEST CONDITION		Ta = 25°C			Ta = - 40~85°C		UNIT	
			V _{CC} (V)	C _L (pF)	MIN.	TYP.	MAX.	MIN.	MAX.		
Propagation Delay Time	t _{PLH}	—	—	3.3 ± 0.3	15	—	5.5	7.9	1.0	9.5	ns
					50	—	8.0	11.4	1.0	13.0	
	5.0 ± 0.5			15	—	3.8	5.5	1.0	6.5		
				50	—	5.3	7.5	1.0	8.5		
Input Capacitance	C _{IN}	—	—		—	4	10	—	10	pF	
Power Dissipation Capacitance	C _{PD}	—	Note (1)		—	15	—	—	—		

Note (1) : C_{PD} is defined as the value of the internal equivalent capacitance which is calculated from the operating current consumption without load.

Average operating current can be obtained by the equation :

$$I_{CC(opr)} = C_{PD} \cdot V_{CC} \cdot f_{IN} + I_{CC}$$

INPUT EQUIVALENT CIRCUIT

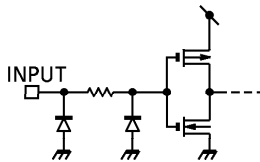

OUTLINE DRAWING
SSOP5-P-0.95

Unit : mm

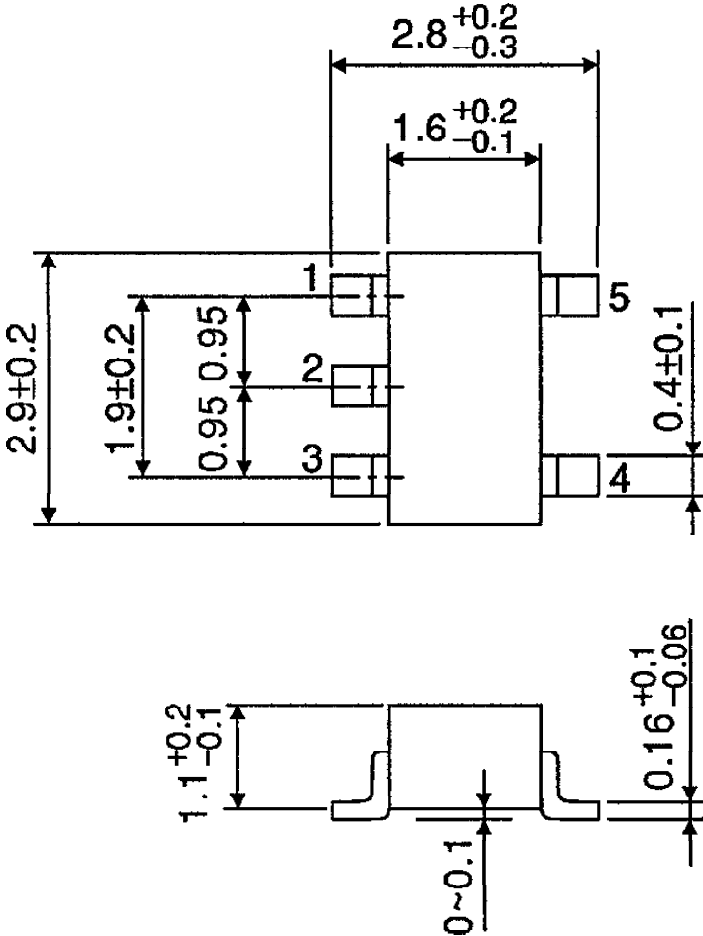

Weight : 0.016g (Typ.)

OUTLINE DRAWING
SSOP5-P-0.65A

Unit : mm

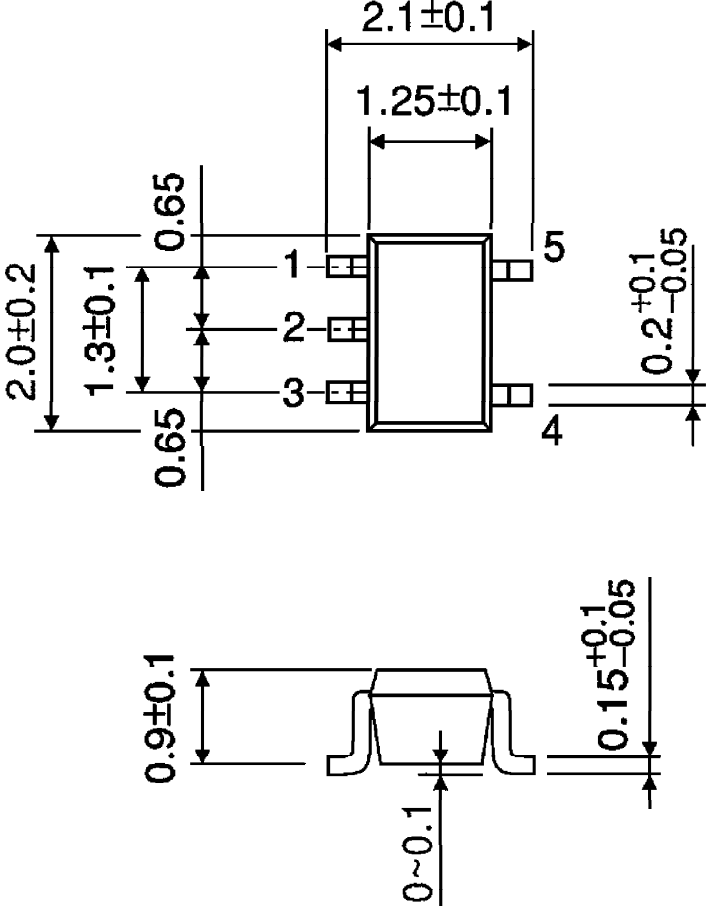

Weight : 0.006g (Typ.)