

SAW Filters

Type: **EFCH**□□□□□**D**□□

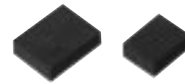

SAW Filter for Cellular Telephone which incorporates highly-precise interdigitated electrodes achieves low insertion loss, high selectivity. Thus the filter has wide applications to bandpass filtering circuits for cellular telephones and portable wireless equipment.

■ Features

- Stable against severe conditions of vibration and shock thanks to the unique monolithic construction of the filter
- Low insertion loss and excellent selectivity
- Contributes to circuit simplification and adjustment free
- Saves the hight on PC board

■ Recommended Applications

- The RF-stage band pass filter for cellular telephone or portable wireless equipment

■ Explanation of Part Numbers

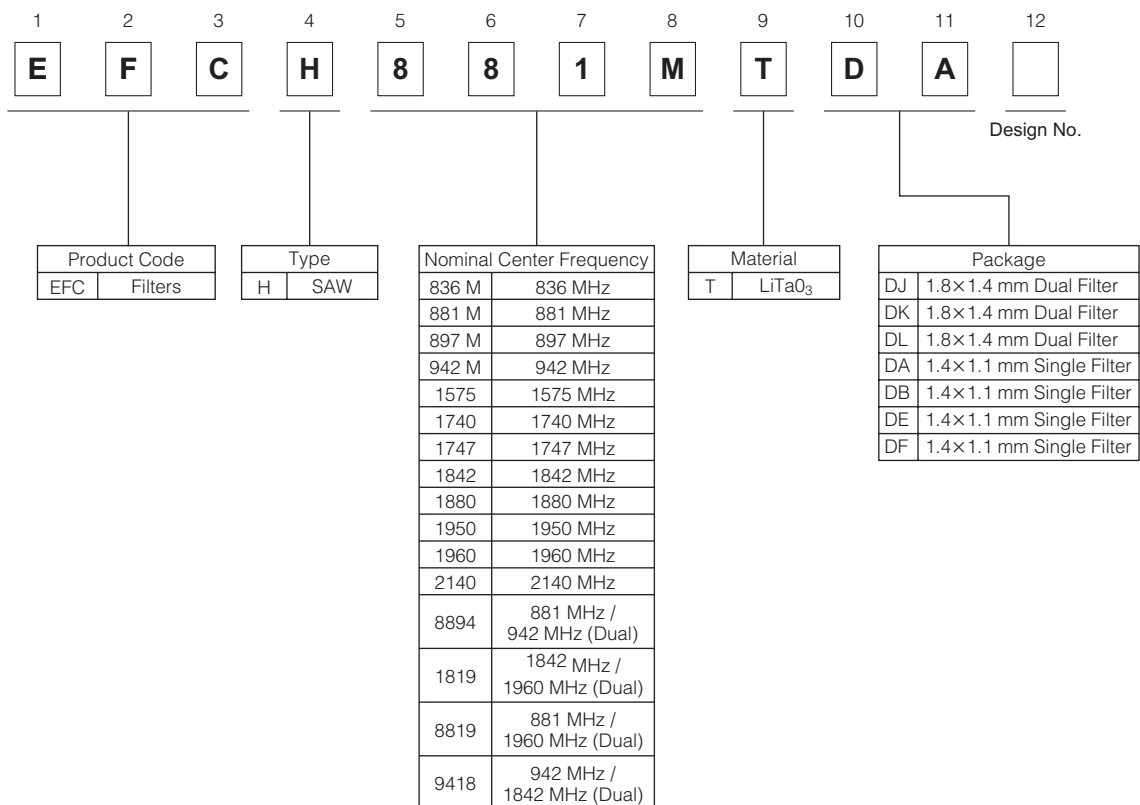

■ Ratings and Characteristics

● Single Filter

Part No.	System	Nominal Center Frequency	Input/Output Impedance	Size	Package
EFCH836MTDB1	CDMA TX	836.5 MHz	UB-UB(50 Ω-50 Ω)	1.4x1.1 mm	DB
EFCH836MTDE1	GSM850 TX		B-UB(100 Ω-50 Ω)	1.4x1.1 mm	DE
EFCH836MTDE6	UMTS Band V Tx		B-UB(200 Ω-50 Ω)	1.4x1.1 mm	DE
EFCH881MTDA1	CDMA RX	881.5 MHz	UB-B(50 Ω-150 Ω)	1.4x1.1 mm	DA
EFCH881MTDAA	GSM850 RX		UB-B(50 Ω-100 Ω)	1.4x1.1 mm	DA
EFCH881MTDB1	UMTS Band V Rx		UB-UB(50 Ω-50 Ω)	1.4x1.1 mm	DB
EFCH897MTDB1	EGSM900 TX	897.5 MHz	UB-UB(50 Ω-50 Ω)	1.4x1.1 mm	DB
EFCH942MTDA1	EGSM900 RX	942.5 MHz	UB-B(50 Ω-150 Ω)	1.4x1.1 mm	DA
EFCH942MTDB1			UB-UB(50 Ω-50 Ω)	1.4x1.1 mm	DB
EFCH1747TDF1	DCS1800 TX	1747.5 MHz	UB-UB(50 Ω-50 Ω)	1.4x1.1 mm	DF
EFCH1842TDA1	DCS1800 RX	1842.5 MHz	UB-B(50 Ω-150 Ω)	1.4x1.1 mm	DA
EFCH1842TDB1			UB-UB(50 Ω-50 Ω)	1.4x1.1 mm	DB
EFCH1880TDF1	PCS1900 TX	1880 MHz	UB-UB(50 Ω-50 Ω)	1.4x1.1 mm	DF
EFCH1960TDA1	PCS1900 RX	1960 MHz	UB-B(50 Ω-150 Ω)	1.4x1.1 mm	DA
EFCH1960TDB1			UB-UB(50 Ω-50 Ω)	1.4x1.1 mm	DB
EFCH1950TDF1	UMTS Band I TX	1950 MHz	UB-UB(50 Ω-50 Ω)	1.4x1.1 mm	DF
EFCH2140TDE1	UMTS Band I RX	2140 MHz	UB-B(50 Ω-100 Ω)	1.4x1.1 mm	DE
EFCH1740TDB1	UMTS Band IV Tx	1740 MHz	UB-UB(50 Ω-50 Ω)	1.4x1.1 mm	DB
EFCH1575TDA1	GPS	1575.42 MHz	UB-B(50 Ω-100 Ω)	1.4x1.1 mm	DA
EFCH1575TDB1			UB-UB(50 Ω-50 Ω)	1.4x1.1 mm	DB
EFCH1575TDB8			UB-UB(50 Ω-50 Ω)	1.4x1.1 mm	DB

● Dual Filter

Part No.	System	Nominal Center Frequency	Input/Output Impedance	Size	Package
EFCH8894TDJ1	GSM850/EGSM900 RX	881.5 MHz	UB-B(50 Ω-150 Ω)	1.8x1.4 mm	DJ
EFCH8894TDJ6		942.5 MHz			
EFCH1819TDK1	DCS1800/PCS1900 RX	1842.5 MHz	UB-B(50 Ω-150 Ω)	1.8x1.4 mm	DK
EFCH1819TDK6		1960 MHz			
EFCH8819TDL1	GSM850/PCS1900 RX	881.5 MHz	UB-B(50 Ω-150 Ω)	1.8x1.4 mm	DL
EFCH8819TDL6		1960 MHz			
EFCH9418TDL1	EGSM900/DCS1800 RX	942.5 MHz	UB-B(50 Ω-150 Ω)	1.8x1.4 mm	DL
EFCH9418TDL6		1842.5 MHz			

* UB : Unbalance, B : Balance

■ Dimensions in mm (not to scale)

DJ, DK, DL type

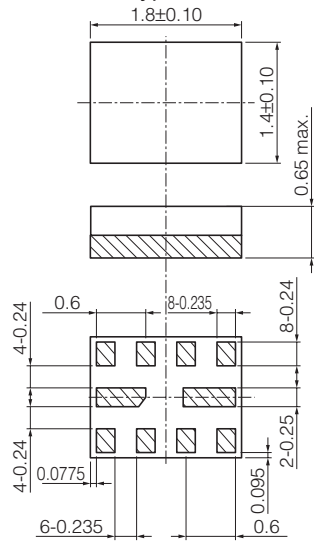

DA, DB type

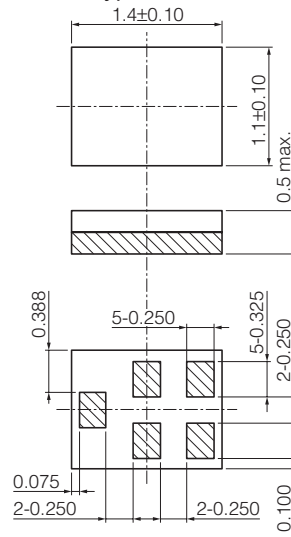

DE, DF type

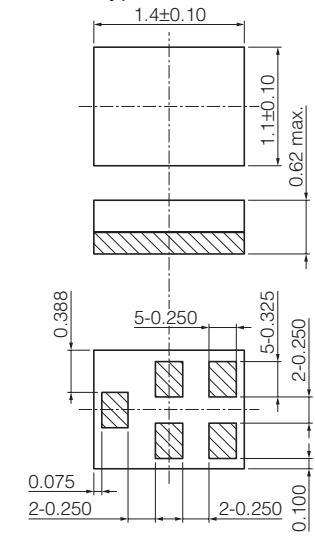

■ Packaging Methods (Taping)

- Minimum Quantity / Packing Unit

Part Number	Packaging Style	Quantity	Packaging Quantity in Carton	Carton Dimensions in mm (L×W×H)
EFCH□□□□□□□□	Embossed Carrier Taping	4000 pcs./reel	20000 pcs.	230×220× 73

- Embossed Carrier Taping

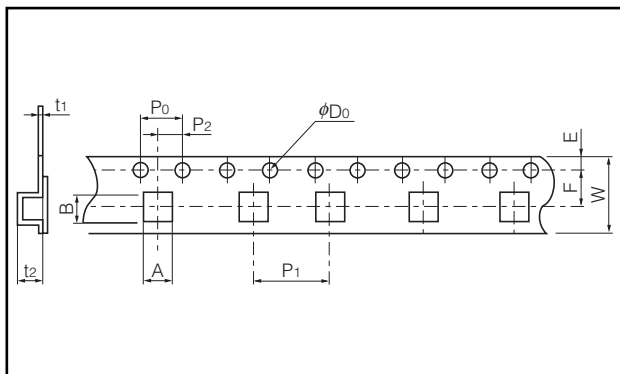

DJ, DK, DL type

Symbol	W	F	E	P ₀	P ₁	P ₂
Dim. (mm)	8.0±0.2	3.50±0.05	1.75±0.10	4.0±0.1	4.0±0.1	2.00±0.05
Symbol	D ₀	t ₁	t ₂	A	B	
Dim. (mm)	φ1.50 ^{+0.1} ₀	0.25±0.05	0.8±0.05	1.7±0.1	2.1±0.1	

DA, DB type

Symbol	W	F	E	P ₀	P ₁	P ₂
Dim. (mm)	8.0±0.2	3.50±0.05	1.75±0.10	4.0±0.1	4.0±0.1	2.00±0.05
Symbol	D ₀	t ₁	t ₂	A	B	
Dim. (mm)	φ1.50 ^{+0.1} ₀	0.25±0.05	0.6±0.1	1.5±0.05	1.8±0.05	

DE, DF type

Symbol	W	F	E	P ₀	P ₁	P ₂
Dim. (mm)	8.0±0.2	3.50±0.05	1.75±0.10	4.0±0.1	4.0±0.1	2.00±0.05
Symbol	D ₀	t ₁	t ₂	A	B	
Dim. (mm)	φ1.50 ^{+0.1} ₀	0.25±0.05	0.72±0.1	1.5±0.05	1.8±0.05	

- Taping Reel

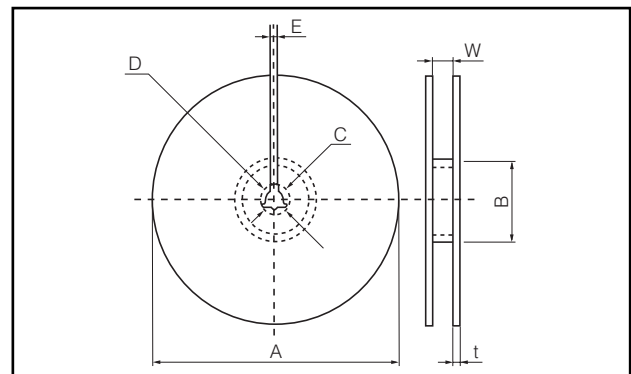

DJ, DK, DL, DA, DB, DE, DF type

Symbol	A	B	C	D	E	W	t
Dim. (mm)	φ178±3	φ60.0±1.0	φ13.0±0.5	φ21.0±1.0	2.0±0.5	9.0±1.0	max. 3