

WIRE WOUND CHIP INDUCTORS SPI/SWI/SCI SERIES

Introductions

The SPI/SWI/SCI series are chip inductors widely used in the communication applications such as cellular phones, pagers, and other electronic devices. The wire wound features advance in higher self resonate frequency, better Q factor, and much more stable performance.

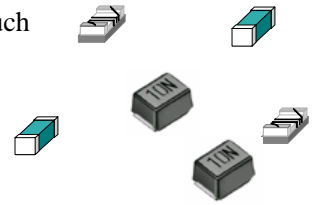

Features

- * Operating temperature -40°C to $+85^{\circ}\text{C}$.
- * Excellent solderability and resistance to soldering heat .
- * Suitable for flow and reflow soldering..
- * Good dimensions, high reliability, and easy surface mount assembly.
- * At least 3 types of materials provide wide range of inductance value for flexible needs.

Part Number Code

SPI 0603 C T 3N3 J

1 2 3 TAPING 4 5 Internal Code

1. Product Type

SPI Series : Laser cut
 SWI Series : Wire Wound
 SCI Series : Molding

2. Chip Dimension

Size (inch) mm	Length (L) (inch) mm	Width (W) (inch) mm	Thickness (T) (inch) mm	Terminal (S) (inch) mm
SPI 0402 1005	(0.039 ± 0.004) 1.00 ± 0.10	(0.020 ± 0.004) 0.50 ± 0.10	(0.020 ± 0.004) 0.50 ± 0.10	(0.0098 ± 0.004) 0.25 ± 0.10
SPI 0603 1608	(0.063 ± 0.008) 1.60 ± 0.20	(0.031 ± 0.008) 0.80 ± 0.20	(0.031 ± 0.008) 0.80 ± 0.20	(0.016 ± 0.004) 0.30 ± 0.10
SWI 0603 1608	(0.063 ± 0.008) 1.60 ± 0.20	(0.041 ± 0.008) 1.05 ± 0.20	(0.041 ± 0.008) 1.05 ± 0.20	(0.014 ± 0.004) 0.35 ± 0.10
SWI 0805 2012	(0.080 ± 0.008) 2.00 ± 0.20	(0.050 ± 0.008) 1.25 ± 0.20	(0.048 ± 0.008) 1.20 ± 0.20	(0.016 ± 0.004) 0.40 ± 0.10
SWI 1008 2520	(0.098 ± 0.008) 2.50 ± 0.20	(0.063 ± 0.008) 2.00 ± 0.20	(0.063 ± 0.008) 1.60 ± 0.20	(0.020 ± 0.004) 0.50 ± 0.10
SWI 1210 3225	(0.126 ± 0.008) 3.20 ± 0.20	(0.098 ± 0.008) 2.50 ± 0.20	(0.087 ± 0.008) 2.20 ± 0.20	(0.020 ± 0.004) 0.50 ± 0.10
SCI 1210 3225	(0.126 ± 0.008) 3.20 ± 0.20	(0.098 ± 0.008) 2.50 ± 0.20	(0.087 ± 0.008) 2.20 ± 0.20	(0.075 ± 0.004) 1.90 ± 0.10
SCI 1812 4532	(0.180 ± 0.008) 4.50 ± 0.20	(0.126 ± 0.008) 3.20 ± 0.20	(0.126 ± 0.008) 3.20 ± 0.20	(0.102 ± 0.004) 2.60 ± 0.10
SCI 2220 5650	(0.22 ± 0.012) 5.60 ± 0.30	(0.197 ± 0.012) 5.00 ± 0.30	(0.197 ± 0.012) 5.00 ± 0.30	(0.158 ± 0.008) 4.00 ± 0.20

SPI SERIES

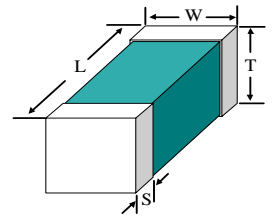

SWI SERIES

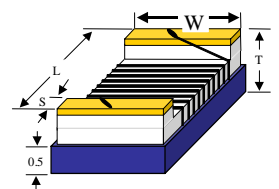

SCI SERIES

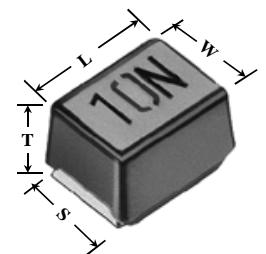

3. Material Type

C : Ceramic

F : Ferrite

H : High Current

4. Inductance Value

3N3 = 3.3 nH

R33 = 330 nH

330 = 33 uH

33N = 33 nH

3R3 = 3.3 uH

331 = 330 uH

5. Tolerance

B = ± 0.15 nH

G = ± 2 %

K = ± 10 %

S = ± 0.3 nH

J = ± 5 %

M = ± 20 %

Specification

Part No.	Inductance ¹ (uH)	Percent Tolerance	Q ² Min	S.R.F. ³ Min (MHZ)	RDC ⁴ Max (OHM)	IDC ⁵ Max (MA)
SCI 1210 FT R10 □□□	0.10 @ 100 MHZ	J, K, M 30	@ 100 MHZ	700	0.44	450
SCI 1210 FT R12 □□□	0.12 @ 25.2 MHZ	J, K, M 30	@ 25.2 MHZ	500	0.22	450
SCI 1210 FT R15 □□□	0.15 @ 25.2 MHZ	J, K, M 30	@ 25.2 MHZ	450	0.25	450
SCI 1210 FT R18 □□□	0.18 @ 25.2 MHZ	J, K, M 30	@ 25.2 MHZ	400	0.28	450
SCI 1210 FT R22 □□□	0.22 @ 25.2 MHZ	J, K, M 30	@ 25.2 MHZ	350	0.32	450
SCI 1210 FT R33 □□□	0.33 @ 25.2 MHZ	J, K, M 30	@ 25.2 MHZ	300	0.40	450
SCI 1210 FT R39 □□□	0.39 @ 25.2 MHZ	J, K, M 30	@ 25.2 MHZ	250	0.45	450
SCI 1210 FT R47 □□□	0.47 @ 25.2 MHZ	J, K, M 30	@ 25.2 MHZ	220	0.50	450
SCI 1210 FT R56 □□□	0.56 @ 25.2 MHZ	J, K, M 30	@ 25.2 MHZ	180	0.55	450
SCI 1210 FT R68 □□□	0.68 @ 25.2 MHZ	J, K, M 30	@ 25.2 MHZ	160	0.60	450
SCI 1210 FT R82 □□□	0.82 @ 25.2 MHZ	J, K, M 30	@ 25.2 MHZ	140	0.65	450
SCI 1210 FT 1R0 □□□	1.0 @ 7.96 MHZ	J, K, M 30	@ 7.96 MHZ	120	0.70	400
SCI 1210 FT 1R2 □□□	1.2 @ 7.96 MHZ	J, K, M 30	@ 7.96 MHZ	100	0.75	390
SCI 1210 FT 1R5 □□□	1.5 @ 7.96 MHZ	J, K, M 30	@ 7.96 MHZ	85	0.85	370
SCI 1210 FT 1R8 □□□	1.8 @ 7.96 MHZ	J, K, M 30	@ 7.96 MHZ	80	0.90	350
SCI 1210 FT 2R2 □□□	2.2 @ 7.96 MHZ	J, K, M 30	@ 7.96 MHZ	75	1.00	320
SCI 1210 FT 2R7 □□□	2.7 @ 7.96 MHZ	J, K, M 30	@ 7.96 MHZ	70	1.10	290
SCI 1210 FT 3R3 □□□	3.3 @ 7.96 MHZ	J, K, M 30	@ 7.96 MHZ	60	1.20	260
SCI 1210 FT 3R9 □□□	3.9 @ 7.96 MHZ	J, K, M 30	@ 7.96 MHZ	55	1.30	250
SCI 1210 FT 4R7 □□□	4.7 @ 7.96 MHZ	J, K, M 30	@ 7.96 MHZ	50	1.50	220
SCI 1210 FT 5R6 □□□	5.6 @ 7.96 MHZ	J, K, M 30	@ 7.96 MHZ	45	1.60	200
SCI 1210 FT 6R8 □□□	6.8 @ 7.96 MHZ	J, K, M 30	@ 7.96 MHZ	40	1.80	180
SCI 1210 FT 8R2 □□□	8.2 @ 7.96 MHZ	J, K, M 30	@ 7.96 MHZ	35	2.00	170
SCI 1210 FT 100 □□□	10 @ 2.52 MHZ	J, K, M 30	@ 2.52 MHZ	30	2.10	150
SCI 1210 FT 120 □□□	12 @ 2.52 MHZ	J, K 30	@ 2.52 MHZ	20	2.50	140
SCI 1210 FT 150 □□□	15 @ 2.52 MHZ	J, K 30	@ 2.52 MHZ	20	2.80	130
SCI 1210 FT 180 □□□	18 @ 2.52 MHZ	J, K 30	@ 2.52 MHZ	20	3.30	120
SCI 1210 FT 220 □□□	22 @ 2.52 MHZ	J, K 30	@ 2.52 MHZ	20	3.70	110
SCI 1210 FT 270 □□□	27 @ 2.52 MHZ	J, K 30	@ 2.52 MHZ	20	5.00	80
SCI 1210 FT 330 □□□	33 @ 2.52 MHZ	J, K 30	@ 2.52 MHZ	17	5.60	70
SCI 1210 FT 390 □□□	39 @ 2.52 MHZ	J, K 30	@ 2.52 MHZ	16	6.40	65
SCI 1210 FT 470 □□□	47 @ 2.52 MHZ	J, K 30	@ 2.52 MHZ	15	7	60
SCI 1210 FT 560 □□□	56 @ 2.52 MHZ	J, K 30	@ 2.52 MHZ	13	8	55
SCI 1210 FT 680 □□□	68 @ 2.52 MHZ	J, K 30	@ 2.52 MHZ	12	9	50
SCI 1210 FT 820 □□□	82 @ 2.52 MHZ	J, K 30	@ 2.52 MHZ	11	10	45
SCI 1210 FT 101 □□□	100 @ 0.796 MHZ	J, K 20	@ 0.796 MHZ	10	11	40

1. Inductance is measured in HP-4285A Precision LCR meter
HP-4287A RF LCR meter with HP-16193 fixture.

2. Q is measured in HP-4285A Precision LCR meter
HP-4287A RF LCR meter with HP-16193 fixture.

3. SRF is measured in HP-8753E RF network analyzer

4. RDC is measured in HP-4338B milliohmmeter.

5. For 15 °C Rise.

PACKING INFORMATION

Packing Quantity

TYPE	PCS/REEL
SPI/SWI 0402	10,000
SPI/SWI 0603	3,000
SWI 0805	2,000
SWI 1008	2,000
SWI 1210	2,000
SCI 1210	1,000
SWI 1812	750
SCI 1812	500

Reel Dimensions

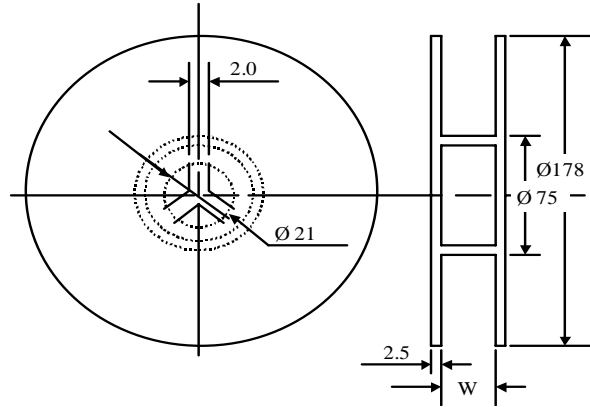

Dimensions (unit: m/m)

TYPE	A	B	P	F	K	T	W
SPI 0402	0.70	1.20	2.00	3.50	0.50	0.70	8.00
SPI 0603	1.00	1.80	4.00	3.50	1.00	0.20	8.00
SWI 0402	0.70	1.20	4.00	3.50	0.50	0.70	8.00
SWI 0603	1.25	1.80	4.00	3.50	1.10	0.20	8.00
SWI 0805	1.42	2.26	4.00	3.50	1.30	0.20	8.00
SWI 1008	2.23	2.73	4.00	3.50	1.80	0.20	8.00
SWI 1210	2.69	3.56	4.00	3.50	2.40	0.20	8.00
SWI 1812	3.60	5.00	8.00	5.50	3.60	0.30	12.00
SCI 1210	2.80	3.60	4.00	3.50	2.40	0.20	8.00
SCI 1812	3.60	5.00	8.00	5.50	3.60	0.30	12.00

Tape Dimension

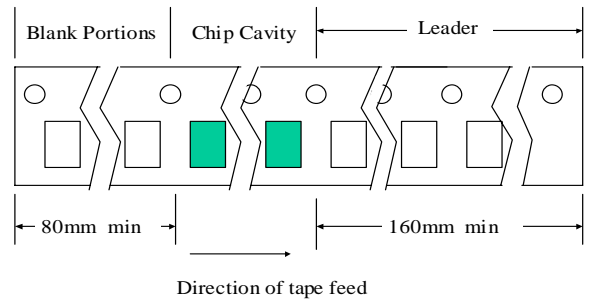
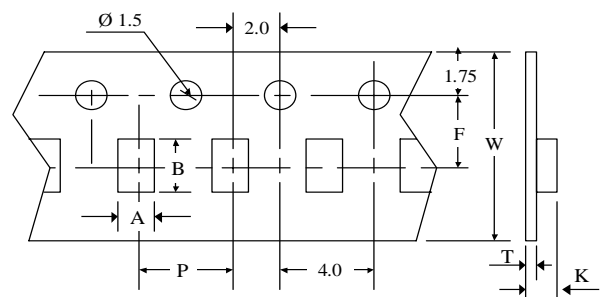

Dimensions (unit: m/m)

TYPE	A	B	C
SPI 0402	1.60	0.50	0.05
SPI 0603	2.10	1.00	0.80
SWI 0402	1.20	0.45	0.65
SWI 0603	1.90	0.65	1.00
SWI 0805	2.60	1.20	1.20
SWI 1008	3.80	1.20	2.20
SWI 1210	4.30	2.00	2.82
SWI 1812	5.30	3.00	4.00
SCI 1210	4.00	2.00	2.00
SCI 1210	6.00	3.00	2.80

Recommended Pattern

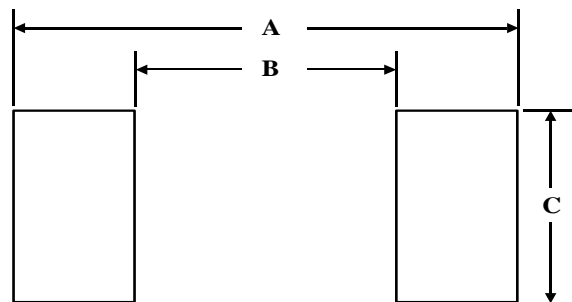

Remark: 1) Blank length 200 mm minimum for loading
2) Blank length 160 mm minimum for unloading