



Application Specific Discretes  
A.S.D.

## ESDA6V1-5P6 TRANSIL™ ARRAY FOR ESD PROTECTION

### MAIN APPLICATIONS

Where transient overvoltage protection in ESD sensitive equipment is required, such as :

- Computers
- Printers
- Communication systems and cellular phones
- Video equipment

This device is particularly adapted to the protection of symmetrical signals.

### FEATURES

- 5 UNIDIRECTIONAL TRANSIL™ FUNCTIONS.
- BREAKDOWN VOLTAGE  $V_{BR} = 6.1V$  MIN
- LOW LEAKAGE CURRENT  $< 500$  nA
- VERY SMALL PCB AREA  $< 2.6$  mm<sup>2</sup>

### DESCRIPTION

The ESDA6V1-5P6 is a monolithic array designed to protect up to 5 lines against ESD transients.

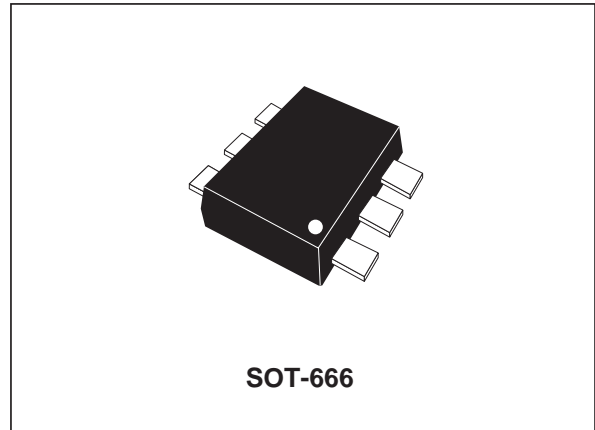
This device is ideal for applications where board space saving is required.

### BENEFITS

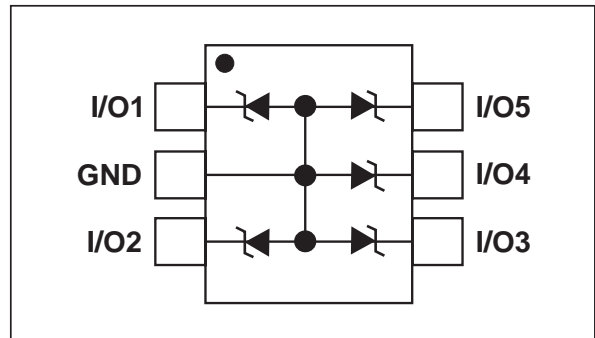
- High ESD protection level.
- High integration.
- Suitable for high density boards.

### COMPLIES WITH THE FOLLOWING STANDARDS :

- **IEC61000-4-2 level 4:** 15 kV (air discharge)  
8 kV (contact discharge)
- **MIL STD 883E-Method 3015-7:** class 3  
25kV HBM (Human Body Model)



### FUNCTIONAL DIAGRAM



## ESDA6V1-5P6

### ABSOLUTE MAXIMUM RATINGS ( $T_{amb} = 25^{\circ}\text{C}$ )

Symbol	Parameter	Test conditions	Value	Unit
$V_{PP}$	ESD discharge - IEC61000-4-2 air discharge IEC61000-4-2 contact discharge		$\pm 15$ $\pm 8$	kV
$P_{PP}$	Peak pulse power (8/20 $\mu\text{s}$ ) (see note 1)	$T_j \text{ initial} = T_{amb}$	150	W
$T_j$	Junction temperature		125	$^{\circ}\text{C}$
$T_{stg}$	Storage temperature range		- 55 to + 150	$^{\circ}\text{C}$
$T_L$	Maximum lead temperature for soldering during 10s at 5mm for case		260	$^{\circ}\text{C}$
$T_{op}$	Operating temperature range		- 40 to + 150	$^{\circ}\text{C}$

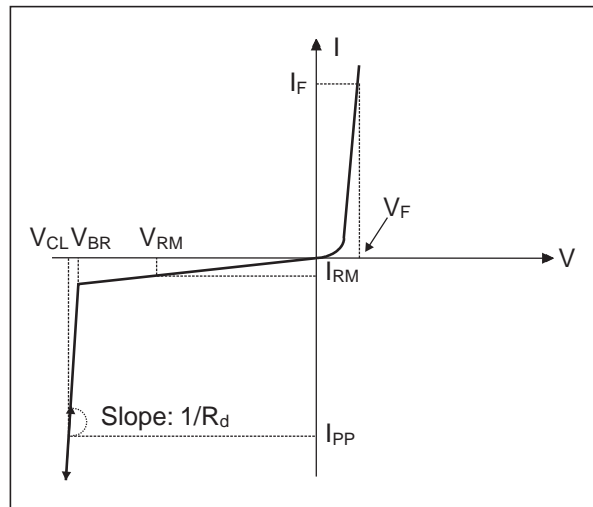
**Note 1:** for a surge greater than the maximum values, the diode will fail in short-circuit.

### THERMAL RESISTANCES

Symbol	Parameter	Value	Unit
$R_{th(j-a)}$	Junction to ambient on printed circuit on recommended pad layout	220	$^{\circ}\text{C}/\text{W}$

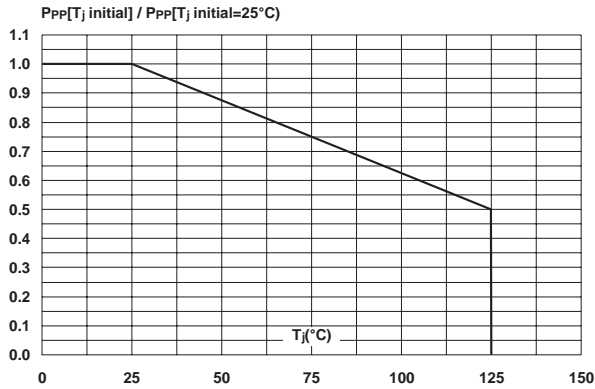
### ELECTRICAL CHARACTERISTICS ( $T_{amb} = 25^{\circ}\text{C}$ )

Symbol	Parameter
$V_{RM}$	Stand-off voltage
$V_{BR}$	Breakdown voltage
$V_{CL}$	Clamping voltage
$I_{RM}$	Leakage current
$I_{PP}$	Peak pulse current
$\alpha T$	Voltage temperature coefficient
$V_F$	Forward voltage drop
$C$	Capacitance per line
$R_d$	Dynamic resistance

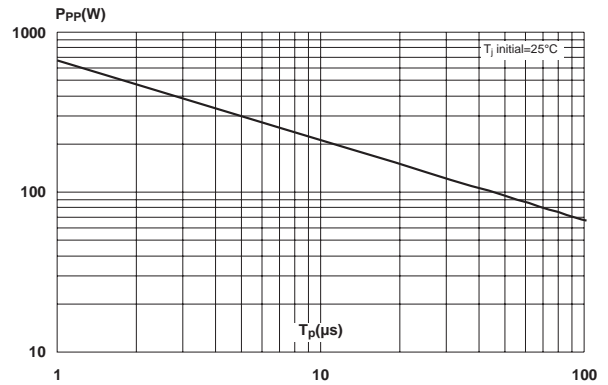


Types	$V_{BR}$ @		$I_R$	$I_{RM}$ @ $V_{RM}$		$R_d$ typ.	$\alpha T$ max.	$C$ typ. @ 0V
	min.	max.		max.				
	V	V	mA	$\mu\text{A}$	V	$\Omega$	$10^{-4}/^{\circ}\text{C}$	pF
ESDA6V1-5P6	6.1	7.2	1	0.5	3	1.5	4.5	70

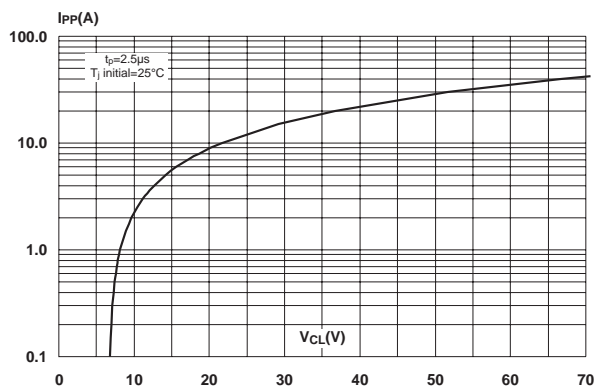
**Fig. 1:** Relative variation of peak pulse power versus initial junction temperature.



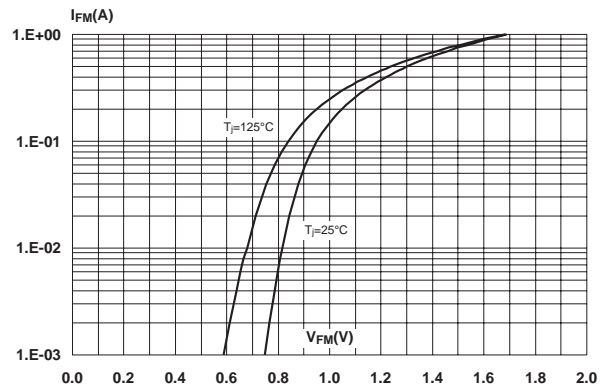
**Fig. 2:** Peak pulse power versus exponential pulse duration.



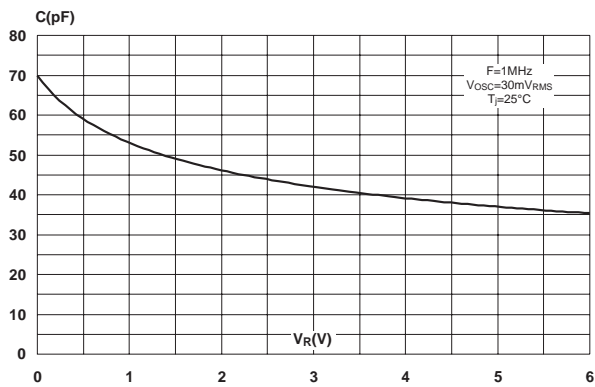
**Fig. 3:** Clamping voltage versus peak pulse current (typical values, rectangular waveform).



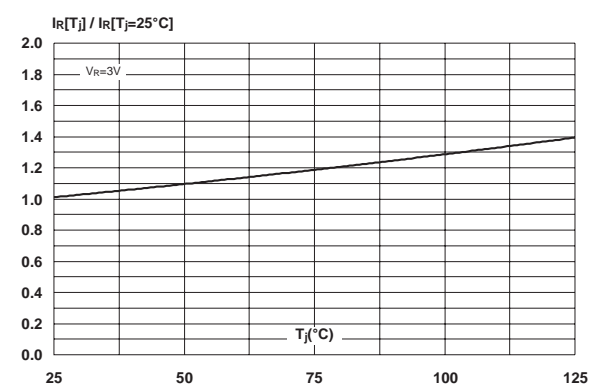
**Fig. 4:** Forward voltage drop versus peak forward current (typical values).



**Fig. 5:** Junction capacitance versus reverse voltage applied (typical values).

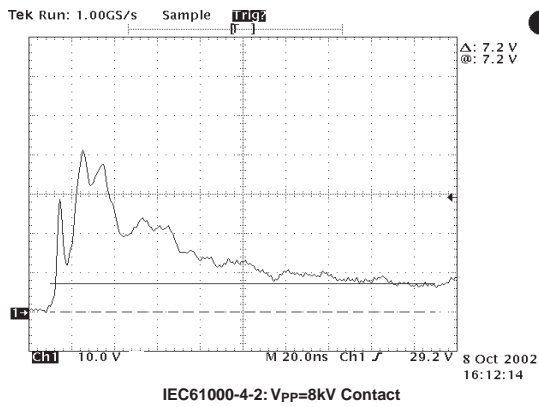


**Fig. 6:** Relative variation of leakage current versus junction temperature (typical values).

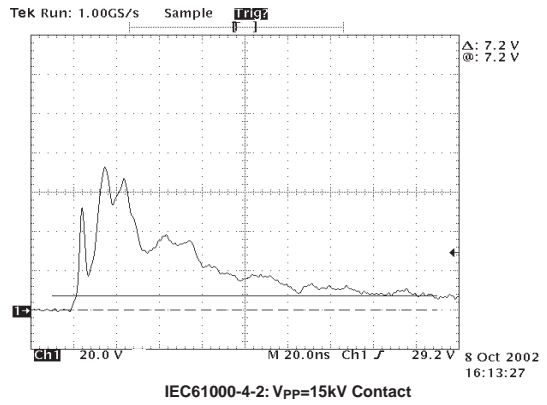


**ESDA6V1-5P6**

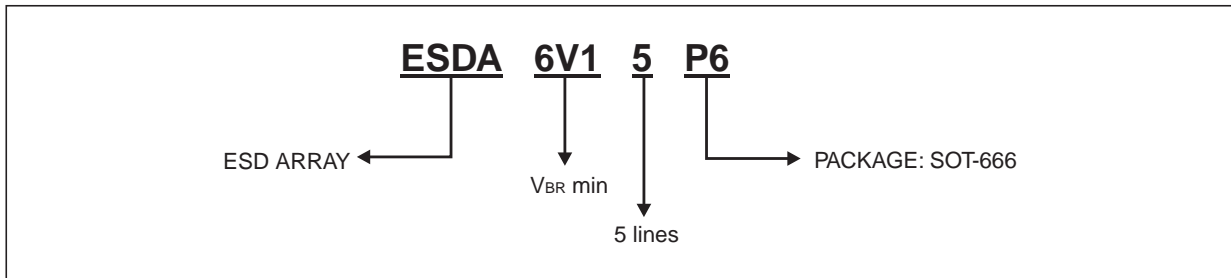
**Fig. 7: ESD response @  $V_{PP}=8kV$  contact.**



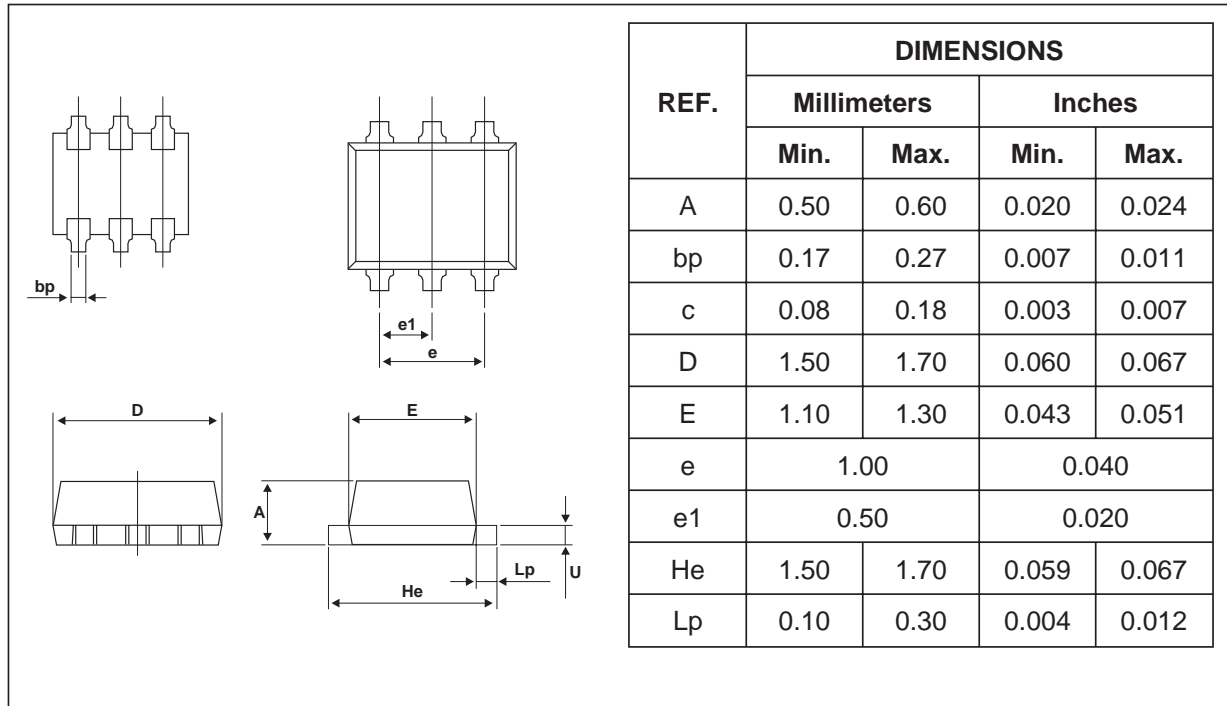
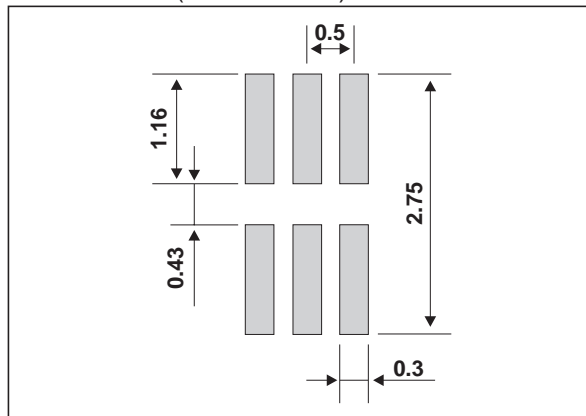
**Fig. 8: ESD response @  $V_{PP}=15kV$  contact.**



**ORDER CODE**



Ordering type	Marking	Package	Weight	Base qty	Delivery mode
ESDA6V1-5P6	C	SOT-666	2.9 mg.	3000	Tape & reel

**PACKAGE MECHANICAL DATA**  
 SOT-666

**FOOT PRINT (in millimeters)**


Information furnished is believed to be accurate and reliable. However, STMicroelectronics assumes no responsibility for the consequences of use of such information nor for any infringement of patents or other rights of third parties which may result from its use. No license is granted by implication or otherwise under any patent or patent rights of STMicroelectronics. Specifications mentioned in this publication are subject to change without notice. This publication supersedes and replaces all information previously supplied. STMicroelectronics products are not authorized for use as critical components in life support devices or systems without express written approval of STMicroelectronics.

The ST logo is a registered trademark of STMicroelectronics

© 2002 STMicroelectronics - Printed in Italy - All rights reserved.

STMicroelectronics GROUP OF COMPANIES

Australia - Brazil - Canada - China - Finland - France - Germany  
 Hong Kong - India - Israel - Italy - Japan - Malaysia - Malta - Morocco - Singapore  
 Spain - Sweden - Switzerland - United Kingdom - United States.

<http://www.st.com>