

OUTLINE

R3132Q/R3133Q Series are CMOS-based low voltage detector ICs with built-in delay circuit, high detector threshold accuracy, and ultra low supply current, which can operate at low voltage.

These ICs can be used as system reset generators, and each of these ICs consists of a voltage reference, a comparator, resistors for setting voltage detector threshold, an output driver transistor, manual reset circuit, and an output delay generator.

Detector threshold is fixed internally with high accuracy and requires no adjustment. When a supply voltage crosses a setting detector threshold voltage from a high value to a lower value, this IC generates reset signal.

R3132Q Series output “L” at its detect, while R3133Q Series output “H”.

Since each of R3132Q/R3133Q Series embeds an output delay generator, during a setting 240ms delay time, which is fixed in the IC, this IC keeps the reset condition after they are released. Released conditions are the case when a supply voltage crosses a setting detector threshold voltage from a low value to a higher value, or when this IC is released from manual reset.

Two output types, Nch open drain type and CMOS type, are available.

Since the package for these ICs are ultra small SC-82AB package, high density mounting of the ICs on board is possible.

FEATURES

- Ultra-low supply current..... Typ. $0.8\mu\text{A}$ (R313xQ27x: $V_{\text{DD}}=3.0\text{V}$)
- Operating Voltage Range 0.8V to 6.0V ($T_{\text{opt}}=25^{\circ}\text{C}$)
- Detector Threshold..... Setting with a step of 0.1V in the range of 1.0V to 5.0V is possible. Further, 2.32V, 2.63V, 2.93V, 3.08V, 4.38V, and 4.63V can be provided as standard.
- Embedded Power on Reset Delay Time Circuit Typ. 240ms
- High Accuracy Detector Threshold..... $\pm 2.0\%$
- High Accuracy Released Delay Time $\pm 15.0\%$
- Low Temperature-Drift Coefficient of Detector Threshold..... Typ. $\pm 100\text{ppm}/^{\circ}\text{C}$
- Two Output Types Nch Open Drain and CMOS
- Small Package SC-82AB

APPLICATIONS

- CPU & Logic Circuit Reset
- Battery Checker
- Window Comparator
- Wave Shaping Circuit
- Battery Backup Circuit
- Power Failure Detector

BLOCK DIAGRAMS

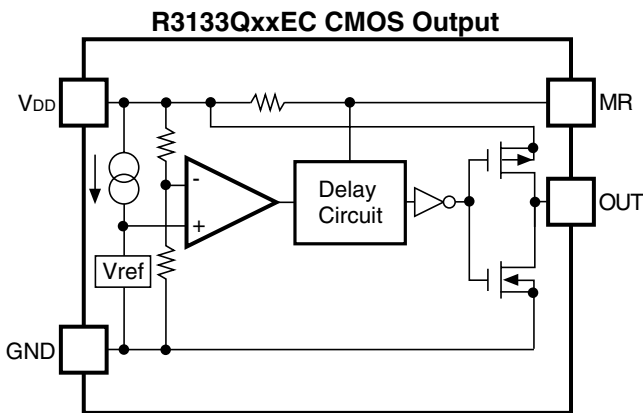
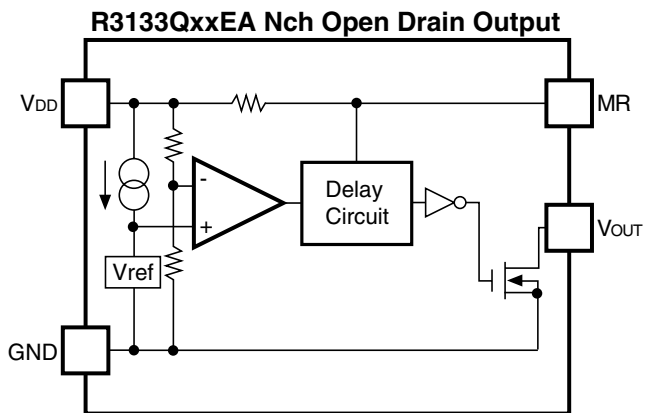
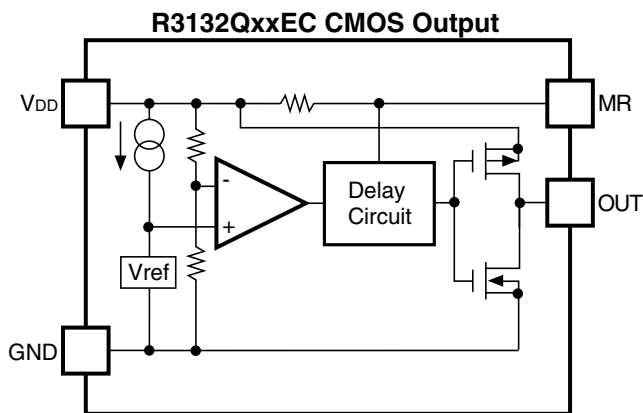
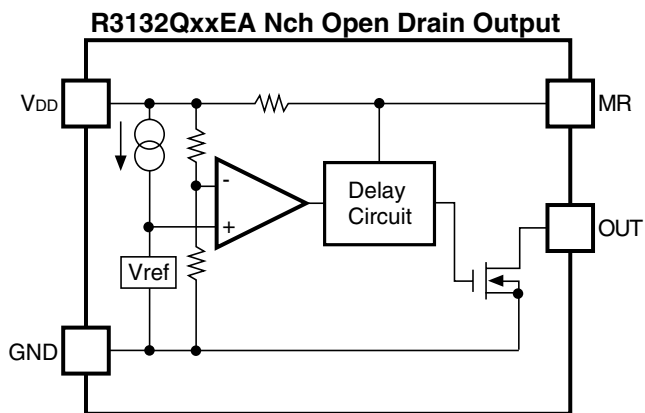

TIMING CHART

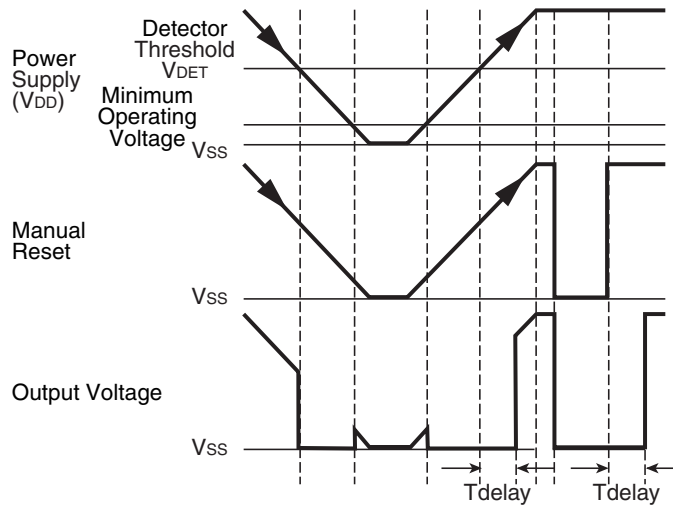

R3132Q Operation Diagram

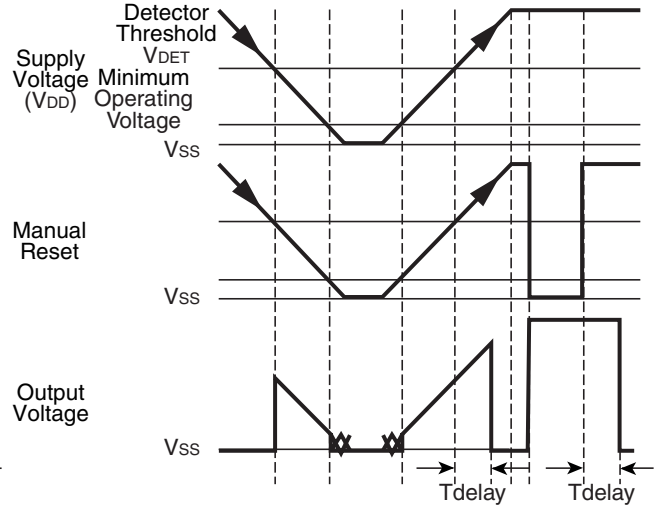

R3133Q Operation Diagram

• Output Delay Operation

Output Delay Time, or T_{delay} is specified as follows:

1. In the case of Nch Open Drain Output:

The time interval from rising edge of V_{DD} pulse (0.8V → (V_{DET}) + 1.0V) to the time at which the output reaches 2.5V under the condition that the output pin (OUT) is pulled up to 5V through a 470kΩ resistor.

2. In the case of CMOS Output:

The time interval from rising edge of V_{DD} pulse (0.8V → (V_{DET}) + 1.0V) to the time at the output reaches V_{DD}/2.

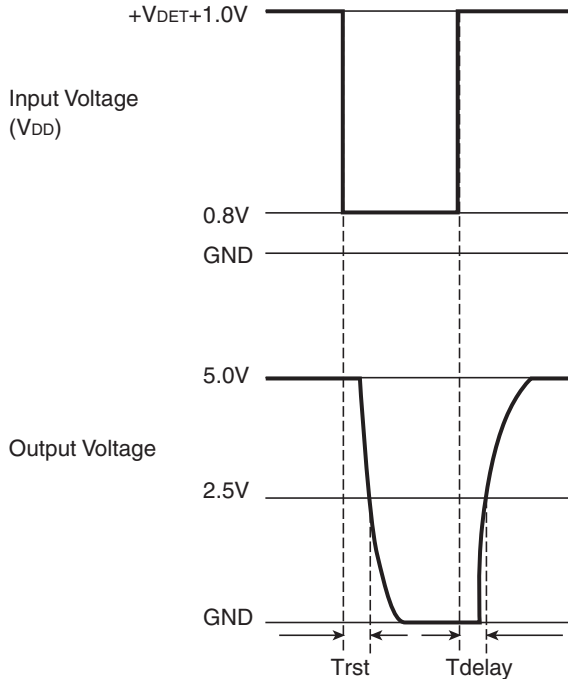

Nch Open Drain Output

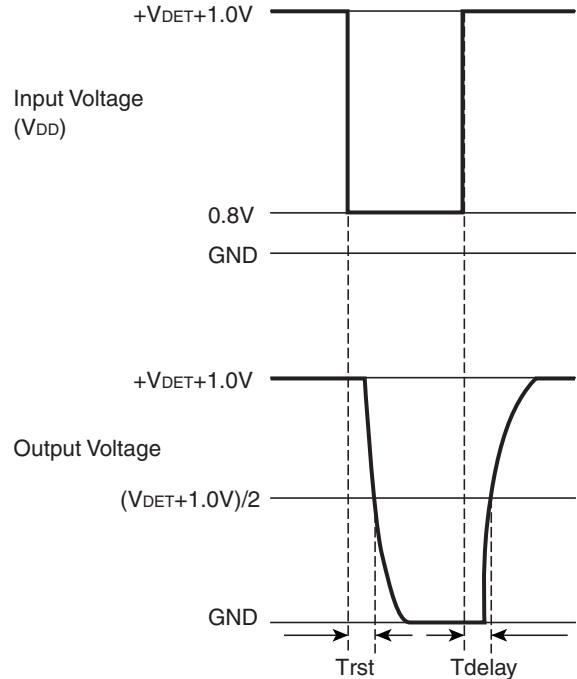

CMOS Output

SELECTION GUIDE

The detector threshold and the output type of R3132Q/R3133Q Series can be designated at the user's request by specifying the part number as follows:

R3132QxxEx (x)-TR ←Part Number
 R3133QxxEx (x)-TR
 ↑ ↑↑ ↑
 a b a' c

Code	Contents
a/a'	Setting Detector Threshold (V _{DET}) Stepwise setting with a step of 0.1V in the range of 1.0V to 5.0V is possible. a' describes the last digit of the next items; 2.32V/2.63V/2.93V/3.08V/4.63V ex. 2.63V Output → R313xQ26Ex3-TR
b	Designation of Output type A: Nch Open Drain C: CMOS
c	TR: Designation of Taping Direction (Refer to Taping Specification)

PIN CONFIGURATION

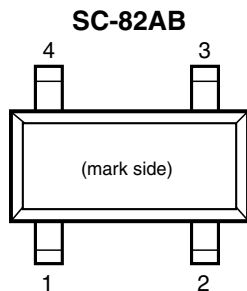

PIN DESCRIPTION

Pin No.	Symbol	Description
1	GND	Ground Pin
2	OUT	Output Pin R3132Q Series: Output “L” at detect, Output “H” at release. R3133Q Series: Output “H” at detect, Output “L” at release.
3	MR	Manual Reset Input Pin Active at “L” input. Pulled up via 1MΩ. If MR pin is not necessary, open this node, or connect to V _{DD} .
4	V _{DD}	Input Pin

ABSOLUTE MAXIMUM RATINGS

Symbol	Item	Rating	Unit
V _{DD}	Supply Voltage	6.5	V
V _{OUT}	Output Voltage	CMOS V _{SS} -0.3 to V _{DD} +0.3	V
		Nch V _{SS} -0.3 to 6.5	V
V _{MR}	Input Voltage	V _{SS} -0.3 to V _{DD} +0.3	V
I _{OUT}	Output Current	20	mA
P _D	Power Dissipation	150	mW
T _{opt}	Operating Temperature Range	-40 to +85	°C
T _{stg}	Storage Temperature Range	-55 to +125	°C
T _{solder}	Soldering Temperature	260°C, 10s	

ABSOLUTE MAXIMUM RATINGS

Absolute Maximum Ratings are threshold limit values that must not be exceeded even for a moment under any conditions.

Moreover, such values for any items must not be reached simultaneously. Operation above these absolute maximum ratings may cause degradation or permanent damage to the device. These are just stress ratings and do not necessarily imply to guarantee operation below these limits.

ELECTRICAL CHARACTERISTICS

T_{opt}=25°C

Symbol	Item	Test Conditions		Min.	Typ.	Max.	Unit
V _{DD}	Operating Voltage	R3132	T _{opt} =25°C	0.75		6.00	V
			-40°C ≤ T _{opt} ≤ 85°C	0.85		6.00	
		R3133	T _{opt} =25°C	0.80		6.00	
			-40°C ≤ T _{opt} ≤ 85°C	0.90		6.00	
V _{DET}	Detector Threshold			V _{DET} × 0.98		V _{DET} × 1.02	V
I _{SS1}	Supply Current1	V _{DD} =V _{DET} -0.1V, I _{OUT} =0A				2.0	μA
I _{SS2}	Supply Current2	V _{DD} =V _{DET} +0.1V, I _{OUT} =0A				2.0	μA
I _{SS3}	Supply Current3	V _{DET} <1.6V	V _{DD} =6.0V, I _{OUT} =0A			3.6	μA
		1.6V ≤ V _{DET} < 2.7V				3.0	
		2.7V ≤ V _{DET}				2.5	
V _{OH}	“H” Output Voltage	Refer to the specification table below.					V
V _{OL}	“L” Output Voltage	Refer to the specification table below.					V
R _{MR}	MR pin pull-up resistance	T _{opt} =25°C		0.5	1.0	4.0	MΩ
Trst ^{*Note1}	Output Delay Time for detect	V _{DD} =V _{DET} to V _{DET} -0.1V			15		μs
Tdelay ^(*2)	Output Delay Time for release	V _{DD} =0.8V to V _{DET} +1.0V		204	240	276	ms
ΔV _{DET} / ΔT _{opt}	Detector Threshold Temperature Coefficient	-40°C ≤ T _{opt} ≤ 85°C			±100		ppm/ °C

Note1) Guaranteed by design, not mass production tested.

• “H” Output Voltage (V_{OH}) table $T_{opt}=25^{\circ}\text{C}$

Products	Test Conditions		Min.	Typ.	Max.	Unit
R3132Qxx1C	$V_{DET} < 1.2\text{V}$	$V_{DD} = V_{DET} + 0.1\text{V}, I_{OH} = -50\mu\text{A}$	$0.8 \times V_{DD}$			V
	$1.2\text{V} \leq V_{DET} < 2.0\text{V}$	$V_{DD} = V_{DET} + 0.1\text{V}, I_{OH} = -150\mu\text{A}$				
	$2.0\text{V} \leq V_{DET} < 3.1\text{V}$	$V_{DD} = V_{DET} + 0.1\text{V}, I_{OH} = -500\mu\text{A}$				
	$3.1\text{V} \leq V_{DET}$	$V_{DD} = V_{DET} + 0.1\text{V}, I_{OH} = -800\mu\text{A}$				
R3133Qxx1C	$V_{DET} < 1.2\text{V}$	$V_{DD} = V_{DET} - 0.1\text{V}, I_{OH} = -10\mu\text{A}$	$0.8 \times V_{DD}$			V
	$1.2\text{V} \leq V_{DET} < 2.0\text{V}$	$V_{DD} = V_{DET} - 0.1\text{V}, I_{OH} = -100\mu\text{A}$				
	$2.0\text{V} \leq V_{DET} < 3.1\text{V}$	$V_{DD} = V_{DET} - 0.1\text{V}, I_{OH} = -500\mu\text{A}$				
	$3.1\text{V} \leq V_{DET}$	$V_{DD} = V_{DET} - 0.1\text{V}, I_{OH} = -800\mu\text{A}$				

• “L” Output Voltage (V_{OL}) table $T_{opt}=25^{\circ}\text{C}$

Symbol	Item	Test Conditions	Min.	Typ.	Max.	Unit	
R3132Qxx1x	$V_{DET} < 1.2\text{V}$	$V_{DD} = V_{DET} - 0.1\text{V}, I_{OL} = 20\mu\text{A}$			0.3	V	
	$1.2\text{V} \leq V_{DET} < 2.0\text{V}$	$V_{DD} = V_{DET} + 0.1\text{V}, I_{OL} = 750\mu\text{A}$					
	$2.0\text{V} \leq V_{DET} < 3.1\text{V}$	$V_{DD} = V_{DET} + 0.1\text{V}, I_{OL} = 1.2\text{mA}$				0.4	V
	$3.1\text{V} \leq V_{DET}$	$V_{DD} = V_{DET} + 0.1\text{V}, I_{OL} = 3.2\text{mA}$					
R3133Qxx1x	$V_{DET} < 1.2\text{V}$	$V_{DD} = V_{DET} - 0.1\text{V}, I_{OH} = 20\mu\text{A}$			0.3	V	
	$1.2\text{V} \leq V_{DET} < 2.0\text{V}$	$V_{DD} = V_{DET} - 0.1\text{V}, I_{OH} = 750\mu\text{A}$					
	$2.0\text{V} \leq V_{DET} < 3.1\text{V}$	$V_{DD} = V_{DET} - 0.1\text{V}, I_{OH} = 1.2\text{mA}$				0.4	V
	$3.1\text{V} \leq V_{DET}$	$V_{DD} = V_{DET} - 0.1\text{V}, I_{OH} = 3.2\text{mA}$					

DETECTOR THRESHOLD SPECIFICATIONS BY PART NUMBER

• R3132Q

Part Number	Operating Voltage				Detector Threshold			Supply Current 1		
	VDD[V]				-VDET[V]			Iss1[μA]		
	Conditions	Max.	Conditions	Max.	Min.	Typ.	Max.	Conditions	Typ.	Max.
R3132Q23Ex2	Topt=25°C	0.75	-40°C≤Topt≤85°C	0.85	2.274	2.320	2.366	VDD=VDET-0.1V IOUT=0A	0.8	2.0
R3132Q26Ex3					2.578	2.630	2.682			
R3132Q29Ex3					2.872	2.930	2.988			
R3132Q30Ex8					3.019	3.080	3.141		0.9	
R3132Q43Ex8					4.293	4.380	4.467			
R3132Q46Ex3					4.538	4.630	4.722			
R3132Q10Ex	Topt=25°C	0.75	-40°C≤Topt≤85°C	0.85	0.980	1.000	1.020	VDD=VDET-0.1V IOUT=0A	0.8	2.0
R3132Q11Ex					1.078	1.100	1.122			
R3132Q12Ex					1.176	1.200	1.224			
R3132Q13Ex					1.274	1.300	1.326			
R3132Q14Ex					1.372	1.400	1.428			
R3132Q15Ex					1.470	1.500	1.530			
R3132Q16Ex					1.568	1.600	1.632			
R3132Q17Ex					1.666	1.700	1.734			
R3132Q18Ex					1.764	1.800	1.836			
R3132Q19Ex					1.862	1.900	1.938			
R3132Q20Ex					1.960	2.000	2.040			
R3132Q21Ex					2.058	2.100	2.142			
R3132Q22Ex					2.156	2.200	2.244			
R3132Q23Ex					2.254	2.300	2.346			
R3132Q24Ex					2.352	2.400	2.448			
R3132Q25Ex					2.450	2.500	2.550			
R3132Q26Ex					2.548	2.600	2.652			
R3132Q27Ex					2.646	2.700	2.754			
R3132Q28Ex					2.744	2.800	2.856			
R3132Q29Ex					2.842	2.900	2.958			
R3132Q30Ex					2.940	3.000	3.060		0.9	
R3132Q31Ex					3.038	3.100	3.162			
R3132Q32Ex					3.136	3.200	3.264			
R3132Q33Ex					3.234	3.300	3.366			
R3132Q34Ex					3.332	3.400	3.468			
R3132Q35Ex					3.430	3.500	3.570			
R3132Q36Ex					3.528	3.600	3.672			
R3132Q37Ex					3.626	3.700	3.774			
R3132Q38Ex					3.724	3.800	3.876			
R3132Q39Ex					3.822	3.900	3.978			
R3132Q40Ex					3.920	4.000	4.080			
R3132Q41Ex					4.018	4.100	4.182			
R3132Q42Ex					4.116	4.200	4.284			
R3132Q43Ex					4.214	4.300	4.386			
R3132Q44Ex	4.312	4.400	4.488							
R3132Q45Ex	4.410	4.500	4.590							
R3132Q46Ex	4.508	4.600	4.692							
R3132Q47Ex	4.606	4.700	4.794							
R3132Q48Ex	4.704	4.800	4.896							
R3132Q49Ex	4.802	4.900	4.998							
R3132Q50Ex	4.900	5.000	5.100							

Supply Current 2			Supply Current 3			“H” Output Voltage	
Iss2[μA]			Iss3[μA]			Voh[V]	
Conditions	Typ.	Max.	Conditions	Typ.	Max.	Conditions	Min.
VDD=VDET+0.1V IOUT=0A	0.8	2.0	VDD=6.0V IOUT=0A	1.2	3.0	VDD=VDET+0.1V IOH=-500uA	0.8× VDD
				1.0	2.5	VDD=VDET+0.1V IOH=-800uA	
VDD=VDET+0.1V IOUT=0A	0.8	2.0	VDD=6.0V IOUT=0A	1.4	3.6	VDD=VDET+0.1V IOH=-50uA	0.8× VDD
						VDD=VDET+0.1V IOH=-150uA	
				1.2	3.0	VDD=VDET+0.1V IOH=-500uA	
						VDD=VDET+0.1V IOH=-800uA	
				1.0	2.5	VDD=VDET+0.1V IOH=-800uA	
						0.8	

R3132QxxA/C, R3133QxxA/C

Part Number	“L” Output Voltage		MR pin “H” Input Voltage		MR pin “L” Input Voltage		MR pin pull-up resistance													
	VoL[V]		VIH[V]		VIL[V]		RMR[MΩ]													
	Conditions	Max.	Conditions	Min.	Conditions	Max.	Conditions	Min.	Typ.	Max.										
R3132Q23Ex2	VDD=VDET-0.1V IOL=+1.2mA	0.3	VDD≥VDET+0.1	0.75× VDD	VDD≥VDET+0.1	0.2× VDD	Topt=25°C	0.5	1.0	4.0										
R3132Q26Ex3																				
R3132Q29Ex3																				
R3132Q30Ex8																				
R3132Q43Ex8	VDD=VDET-0.1V IOL=+3.2mA	0.4	VDD≥VDET+0.1	0.75× VDD	VDD≥VDET+0.1	0.2× VDD	Topt=25°C	0.5	1.0	4.0										
R3132Q46Ex3																				
R3132Q10Ex	VDD=VDET-0.1V IOL=+20μA	0.3	VDD≥VDET+0.1	0.75× VDD	VDD≥VDET+0.1	0.2× VDD	Topt=25°C	0.5	1.0	4.0										
R3132Q11Ex																				
R3132Q12Ex																				
R3132Q13Ex																				
R3132Q14Ex																				
R3132Q15Ex																				
R3132Q16Ex																				
R3132Q17Ex																				
R3132Q18Ex																				
R3132Q19Ex																				
R3132Q20Ex																				
R3132Q21Ex																				
R3132Q22Ex																				
R3132Q23Ex																				
R3132Q24Ex	VDD=VDET-0.1V IOL=+1.2mA	0.3	VDD≥VDET+0.1	0.75× VDD	VDD≥VDET+0.1	0.2× VDD	Topt=25°C	0.5	1.0	4.0										
R3132Q25Ex																				
R3132Q26Ex																				
R3132Q27Ex																				
R3132Q28Ex																				
R3132Q29Ex																				
R3132Q30Ex																				
R3132Q31Ex											VDD=VDET-0.1V IOL=+3.2mA	0.4	VDD≥VDET+0.1	0.75× VDD	VDD≥VDET+0.1	0.2× VDD	Topt=25°C	0.5	1.0	4.0
R3132Q32Ex																				
R3132Q33Ex																				
R3132Q34Ex																				
R3132Q35Ex																				
R3132Q36Ex																				
R3132Q37Ex																				
R3132Q38Ex																				
R3132Q39Ex																				
R3132Q40Ex																				
R3132Q41Ex																				
R3132Q42Ex																				
R3132Q43Ex																				
R3132Q44Ex																				
R3132Q45Ex																				
R3132Q46Ex																				
R3132Q47Ex																				
R3132Q48Ex																				
R3132Q49Ex																				
R3132Q50Ex																				

Output Delay Time for Release				Detector Threshold Temperature Coefficient	
Tdelay[ms]				$\Delta V_{DET}/\Delta T_{opt}$ [ppm/°C]	
Conditions	Min.	Typ.	Max.	Conditions	
V _{DD} =0.8V→ V _{DET} +1.0V T _{opt} =25°C	204	240	276	-40°C≤T _{opt} ≤85°C	±100
V _{DD} =0.8V→ V _{DET} +1.0V T _{opt} =25°C	204	240	276	-40°C≤T _{opt} ≤85°C	±100

• R3133Q

Part Number	Operating Voltage				Detector Threshold			Supply Current 1		
	V _{DD} [V]				-V _{DET} [V]			I _{SS1} [μA]		
	Conditions	Max.	Conditions	Max.	Min.	Typ.	Max.	Conditions	Typ.	Max.
R3133Q23Ex2	T _{opt} =25°C	0.80	-40°C≤T _{opt} ≤85°C	0.90	2.274	2.320	2.366	V _{DD} =V _{DET} -0.1V I _{OUT} =0A	0.8	2.0
R3133Q26Ex3					2.578	2.630	2.682			
R3133Q29Ex3					2.872	2.930	2.988			
R3133Q30Ex8					3.019	3.080	3.141			
R3133Q43Ex8					4.293	4.380	4.467			
R3133Q46Ex3					4.538	4.630	4.722			
R3133Q10Ex	T _{opt} =25°C	0.80	-40°C≤T _{opt} ≤85°C	0.90	0.980	1.000	1.020	V _{DD} =V _{DET} -0.1V I _{OUT} =0A	0.8	2.0
R3133Q11Ex					1.078	1.100	1.122			
R3133Q12Ex					1.176	1.200	1.224			
R3133Q13Ex					1.274	1.300	1.326			
R3133Q14Ex					1.372	1.400	1.428			
R3133Q15Ex					1.470	1.500	1.530			
R3133Q16Ex					1.568	1.600	1.632			
R3133Q17Ex					1.666	1.700	1.734			
R3133Q18Ex					1.764	1.800	1.836			
R3133Q19Ex					1.862	1.900	1.938			
R3133Q20Ex					1.960	2.000	2.040			
R3133Q21Ex					2.058	2.100	2.142			
R3133Q22Ex					2.156	2.200	2.244			
R3133Q23Ex					2.254	2.300	2.346			
R3133Q24Ex					2.352	2.400	2.448			
R3133Q25Ex					2.450	2.500	2.550			
R3133Q26Ex					2.548	2.600	2.652			
R3133Q27Ex					2.646	2.700	2.754			
R3133Q28Ex					2.744	2.800	2.856			
R3133Q29Ex					2.842	2.900	2.958			
R3133Q30Ex					2.940	3.000	3.060			
R3133Q31Ex					3.038	3.100	3.162			
R3133Q32Ex					3.136	3.200	3.264			
R3133Q33Ex					3.234	3.300	3.366			
R3133Q34Ex					3.332	3.400	3.468			
R3133Q35Ex					3.430	3.500	3.570			
R3133Q36Ex					3.528	3.600	3.672			
R3133Q37Ex					3.626	3.700	3.774			
R3133Q38Ex					3.724	3.800	3.876			
R3133Q39Ex					3.822	3.900	3.978			
R3133Q40Ex	3.920	4.000	4.080							
R3133Q41Ex	4.018	4.100	4.182							
R3133Q42Ex	4.116	4.200	4.284							
R3133Q43Ex	4.214	4.300	4.386							
R3133Q44Ex	4.312	4.400	4.488							
R3133Q45Ex	4.410	4.500	4.590							
R3133Q46Ex	4.508	4.600	4.692							
R3133Q47Ex	4.606	4.700	4.794							
R3133Q48Ex	4.704	4.800	4.896							
R3133Q49Ex	4.802	4.900	4.998							
R3133Q50Ex	4.900	5.000	5.100	0.9						

Supply Current 2			Supply Current 3			“H” Output Voltage	
Iss2[μ A]			Iss3[μ A]			Voh[V]	
Conditions	Typ.	Max.	Conditions	Typ.	Max.	Conditions	Min.
VDD=VDET+0.1V IOUT=0A	0.8	2.0	VDD=6.0V IOUT=0A	1.2	3.0	VDD=VDET-0.1V IOH=-500uA	0.8× VDD
				1.0	2.5	VDD=VDET-0.1V IOH=-800uA	
VDD=VDET+0.1V IOUT=0A	0.8	2.0	VDD=6.0V IOUT=0A	1.4	3.6	VDD=VDET-0.1V IOH=-10uA	0.8× VDD
					VDD=VDET-0.1V IOH=-100uA		
				1.2	3.0	VDD=VDET-0.1V IOH=-500uA	
				1.0	2.5	VDD=VDET-0.1V IOH=-800uA	
				0.8			

R3132QxxA/C, R3133QxxA/C

Part Number	“L” Output Voltage		MR pin “H” Input Voltage		MR pin “L” Input Voltage		MR pin pull-up resistance			
	VoL[V]		VIH[V]		VIL[V]		RMR[MΩ]			
	Conditions	Max.	Conditions	Max.	Conditions	Min.	Conditions	Min.	Typ.	Max.
R3133Q23Ex2	VDD=VDET+0.1V IOL=+1.2mA	0.3	VDD≥VDET+0.1	0.75× VDD	VDD≥VDET+0.1	0.2× VDD	Topt=25°C	0.5	1.0	2.0
R3133Q26Ex3										
R3133Q29Ex3										
R3133Q30Ex8	VDD=VDET+0.1V IOL=+3.2mA	0.4	VDD≥VDET+0.1	0.75× VDD	VDD≥VDET+0.1	0.2× VDD	Topt=25°C	0.5	1.0	2.0
R3133Q43Ex8										
R3133Q46Ex3	VDD=VDET+0.1V IOL=+20μA	0.3	VDD≥VDET+0.1	0.75× VDD	VDD≥VDET+0.1	0.2× VDD	Topt=25°C	0.5	1.0	2.0
R3133Q10Ex										
R3133Q11Ex	VDD=VDET+0.1V IOL=+750μA	0.3	VDD≥VDET+0.1	0.75× VDD	VDD≥VDET+0.1	0.2× VDD	Topt=25°C	0.5	1.0	2.0
R3133Q12Ex										
R3133Q13Ex										
R3133Q14Ex										
R3133Q15Ex										
R3133Q16Ex										
R3133Q17Ex										
R3133Q18Ex										
R3133Q19Ex										
R3133Q20Ex										
R3133Q21Ex	VDD=VDET+0.1V IOL=+1.2mA	0.4	VDD≥VDET+0.1	0.75× VDD	VDD≥VDET+0.1	0.2× VDD	Topt=25°C	0.5	1.0	2.0
R3133Q22Ex										
R3133Q23Ex										
R3133Q24Ex										
R3133Q25Ex										
R3133Q26Ex										
R3133Q27Ex										
R3133Q28Ex										
R3133Q29Ex										
R3133Q30Ex										
R3133Q31Ex	VDD=VDET+0.1V IOL=+3.2mA	0.4	VDD≥VDET+0.1	0.75× VDD	VDD≥VDET+0.1	0.2× VDD	Topt=25°C	0.5	1.0	2.0
R3133Q32Ex										
R3133Q33Ex										
R3133Q34Ex										
R3133Q35Ex										
R3133Q36Ex										
R3133Q37Ex										
R3133Q38Ex										
R3133Q39Ex										
R3133Q40Ex										
R3133Q41Ex										
R3133Q42Ex										
R3133Q43Ex										
R3133Q44Ex										
R3133Q45Ex										
R3133Q46Ex										
R3133Q47Ex										
R3133Q48Ex										
R3133Q49Ex										
R3133Q50Ex										

Output Delay Time for Release				Detector Threshold Temperature Coefficient	
Tdelay[ms]				$\Delta V_{DET}/\Delta T_{opt}$ [ppm/°C]	
Conditions	Min.	Typ.	Max.	Conditions	Typ.
V _{DD} =0.8V→ V _{DET} +1.0V T _{opt} =25°C	204	240	276	-40°C≤T _{opt} ≤85°C	±100
V _{DD} =0.8V→ V _{DET} +1.0V T _{opt} =25°C	204	240	276	-40°C≤T _{opt} ≤85°C	±100

OPERATION

- Operation of R3132Q Series

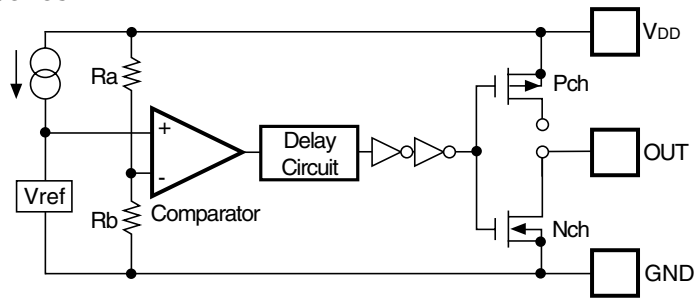

Block Diagram

- CMOS Output Type

OUT pin is connected to the drain of Nch Tr. and Pch Tr. in this IC.

- Nch Open Drain Output Type

OUT pin is connected to the drain of Nch Tr. in this IC.

(OUT pin should be pulled up to V_{DD} or an external voltage level.)

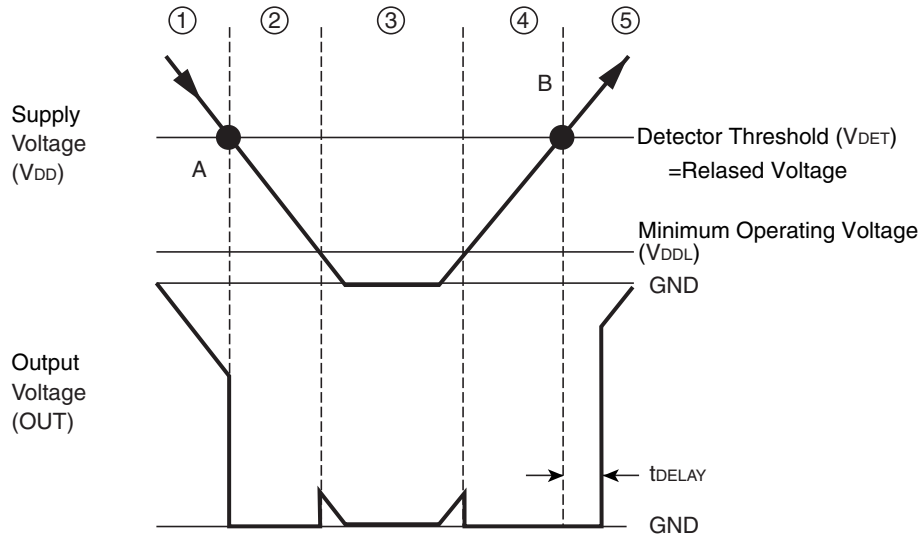

Operating Diagram

In the above diagram,

- ① Output voltage becomes equal to supply voltage (Nch open drain output type; equal to pull-up Voltage).
- ② When the supply voltage is down to the detector threshold level (Point A), $V_{ref} \geq V_{DD} \times R_b / (R_a + R_b)$ is true. Then, the output of the comparator is reversed, thus output voltage becomes equal to GND level.
- ③ When the supply voltage is lower than minimum operating voltage, the output of transistor is indefinite, therefore the output is also indefinite.
- ④ Output voltage is equal to GND level.
- ⑤ When the supply voltage is higher than the released voltage (Point B), $V_{ref} \geq V_{DD} \times R_b / (R_a + R_b)$ is true. Then the output of the comparator is reversed, thus the output voltage becomes equal to the supply voltage (Nch open drain output type; equal to pull-up voltage).

*There is no hysteresis range between the detector threshold and the released voltage.

• Operation of R3133Q Series

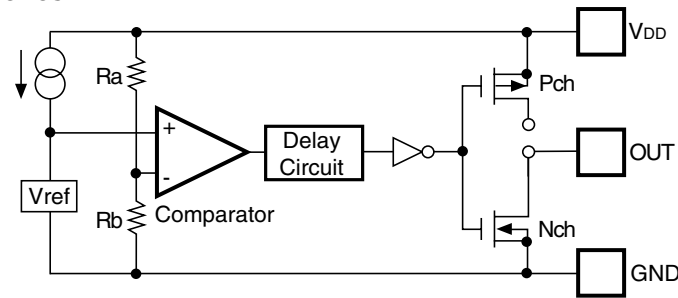

Block Diagram

• CMOS Output Type:

Out pin is connected to the drain of Nch Tr. and Pch Tr. in this IC.

• Nch Open Drain Output Type: I

Out pin is connected to the drain of Nch Tr. in this IC.

(OUT pin should be pulled up to V_{DD} or an external voltage level.)

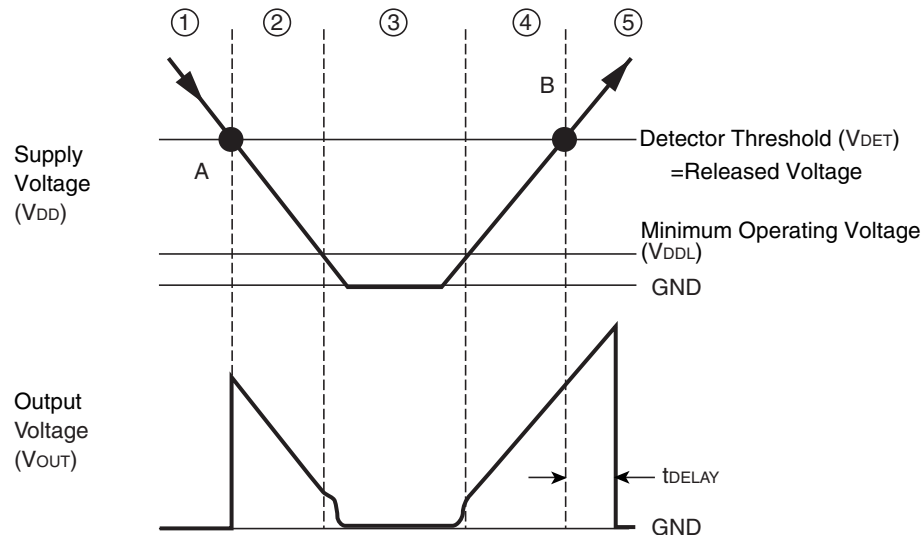

Operation Diagram

In the above diagram,

- ① Output voltage becomes equal to GND level.
- ② When the supply voltage is down to the detector threshold level (Point A), $V_{ref} \geq V_{DD} \times R_b / (R_a + R_b)$ is true. Then, the output of the comparator is reversed, thus output voltage becomes equal to the supply voltage (Nch open drain output type; equal to pull-up voltage).
- ③ When the supply voltage is lower than minimum operating voltage, the output of transistor is indefinite, therefore the output is also indefinite. (Nch open drain output type; the output voltage level is equal to pull-up voltage.)
- ④ Output voltage is equal to the supply voltage. (Nch open drain output type; equal to pull-up Voltage.)
- ⑤ When the supply voltage is higher than the released voltage (Point B), $V_{ref} \leq V_{DD} \times R_b / (R_a + R_b)$ is true. Then the output of the comparator is reversed, thus the output voltage becomes equal to GND level after the output delay time.

*There is no hysteresis range between the detector threshold and the released voltage.

TECHNICAL NOTES

When the IC is released, if a large pulse (glitch) which crosses the detector threshold voltage is in, the IC may not maintain the released condition. The amplitude of the pulse ($V_{DET}-V_{DDmin}$) and the pulse width the IC can maintain the released level is described in the graph as follows:

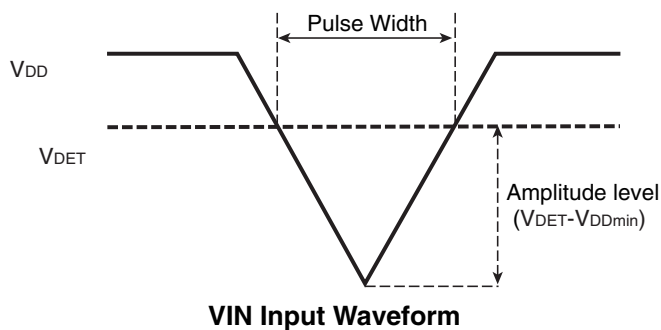
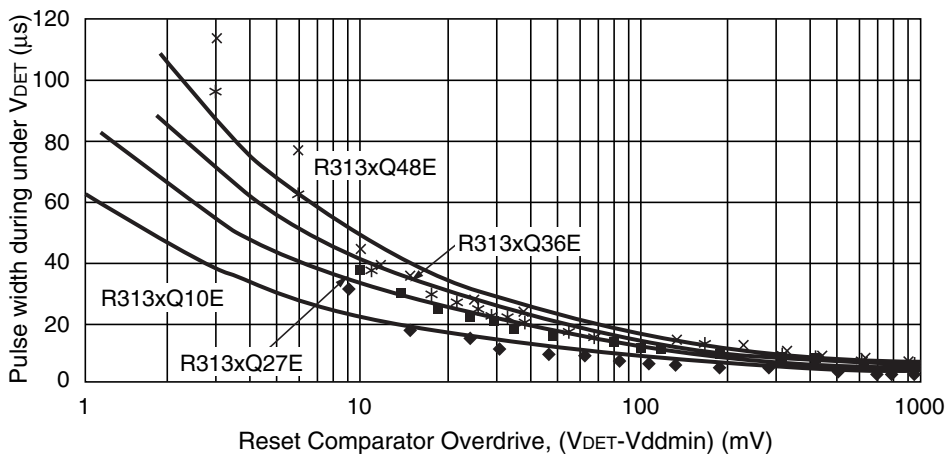

Notes:

The graph above shows the condition for the maximum transient duration without generating a reset. If the larger amplitude or larger pulse width noise than the graph may be on the V_{DD} , the reset signal may be generated.

Application Notes

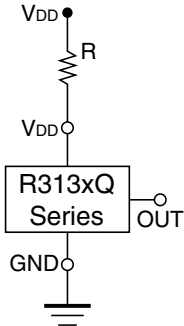

Figure A

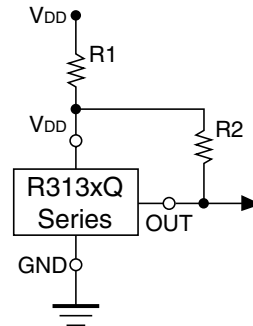
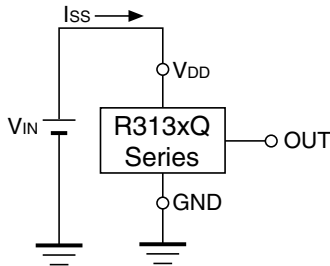

Figure B

The connection such as Figure A and Figure B may cause the loop oscillation because of the shoot-through current. Not only that, these types connection may make shift the detector threshold level because of the voltage drop-out with consumption current of the IC itself.

TEST CIRCUITS

- Test Circuit for Supply Current



- Test Circuit for Detector Threshold (CMOS Output type; pull-up part is not necessary.)

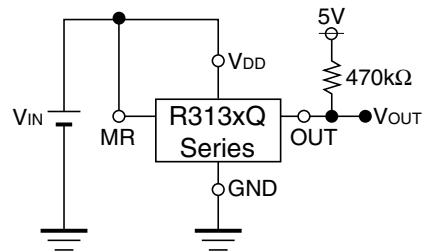

- Test Circuit for “H” Output Voltage (CMOS Output Type only)

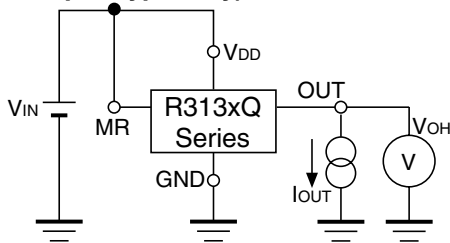

- Test Circuit for “L” Output Voltage

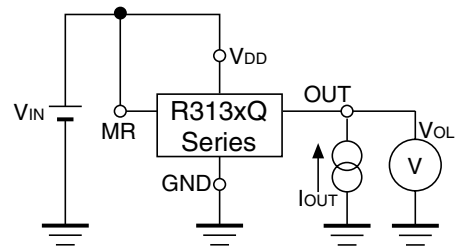

- Test Circuit for MR pin Input Voltage (CMOS Output type; pull-up part is not necessary.)

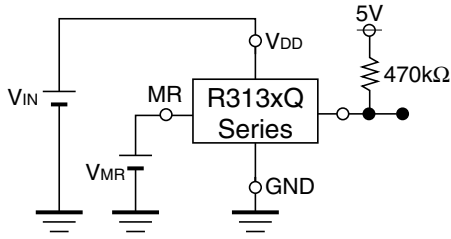

- Test Circuit for MR pin Pull-up Resistance

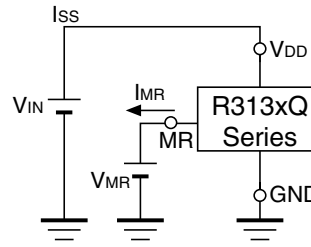

- Test Circuit for Off Leakage Current

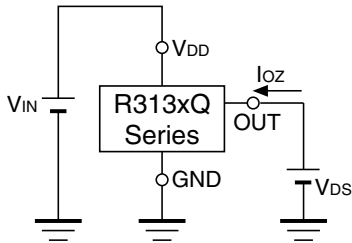

- Test Circuit for Output Delay Time (CMOS Output type; pull-up is not necessary.)

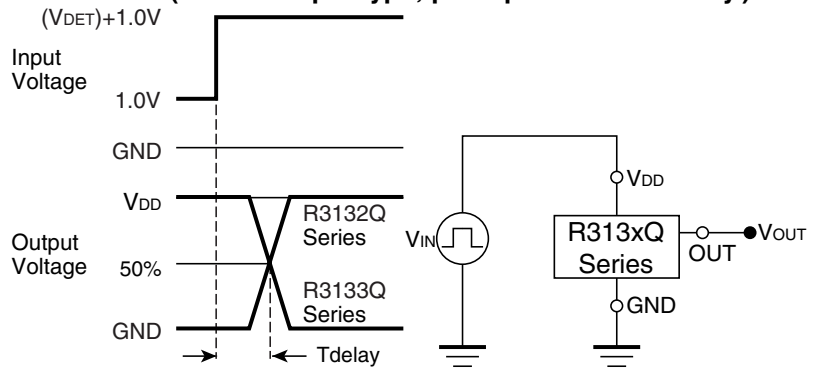

TYPICAL CHARACTERISTICS

- 1) Supply Current vs. Input Voltage

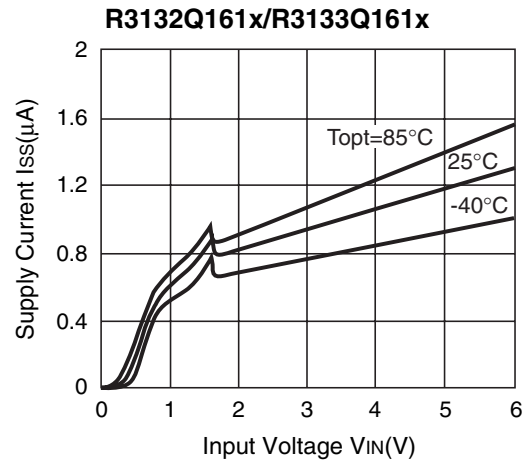
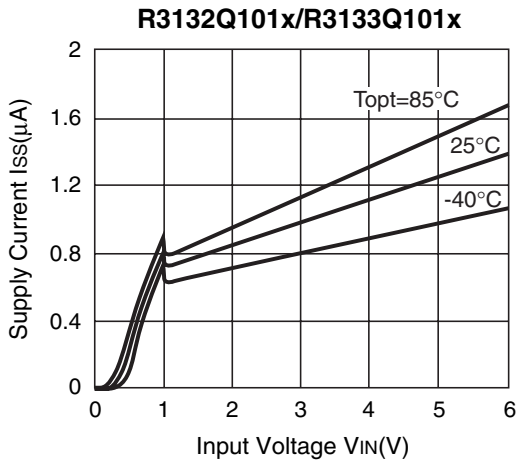

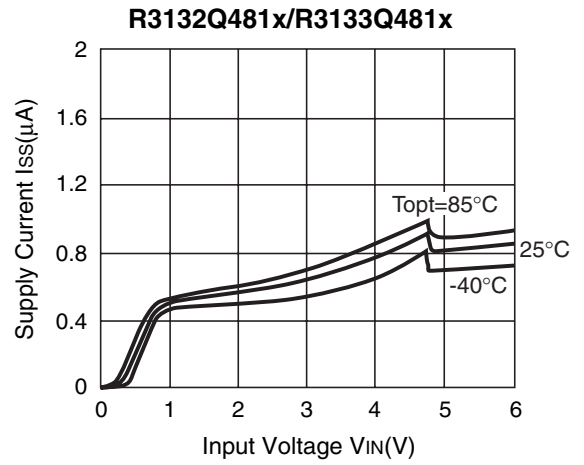
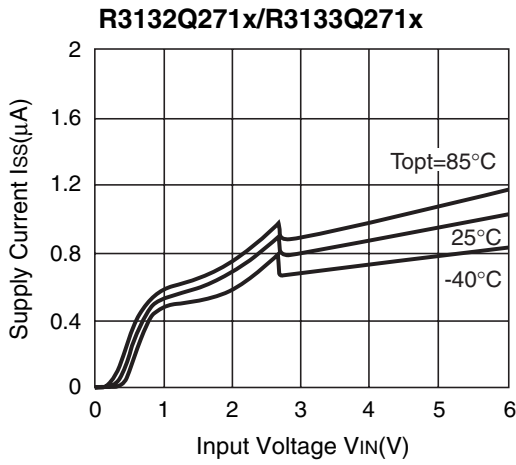

2) Detector Threshold vs. Temperature

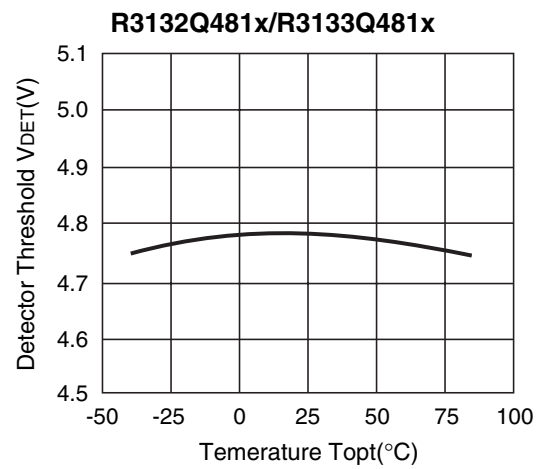
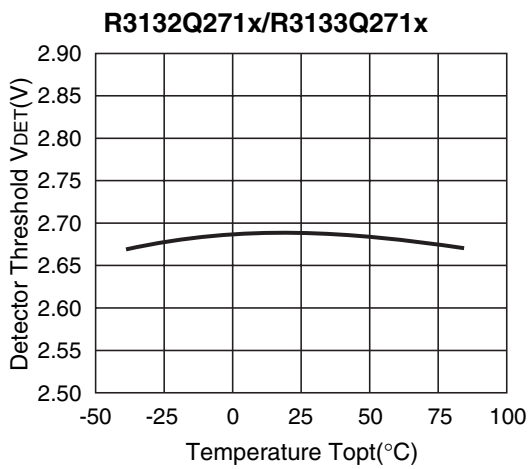
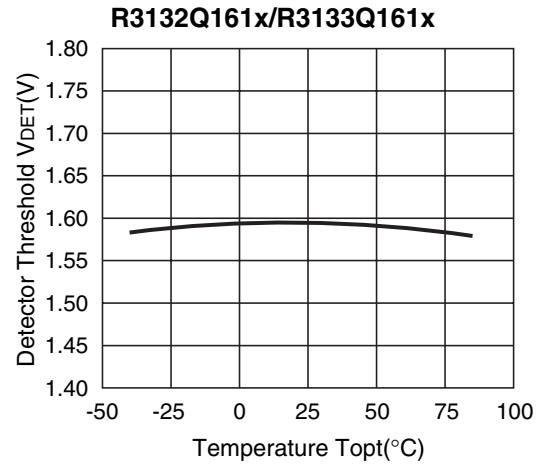
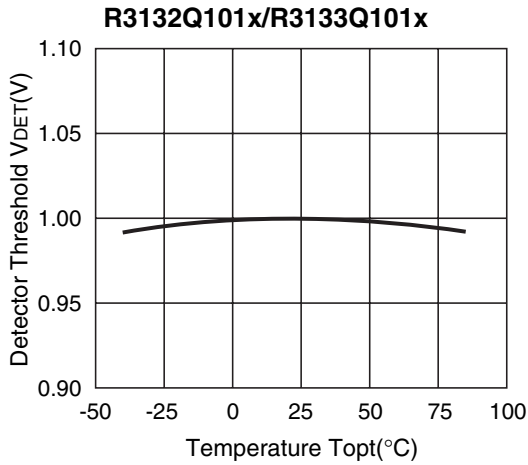

3) Nch Driver Output Current vs. V_{DS} ($T_{opt}=25^{\circ}C$)

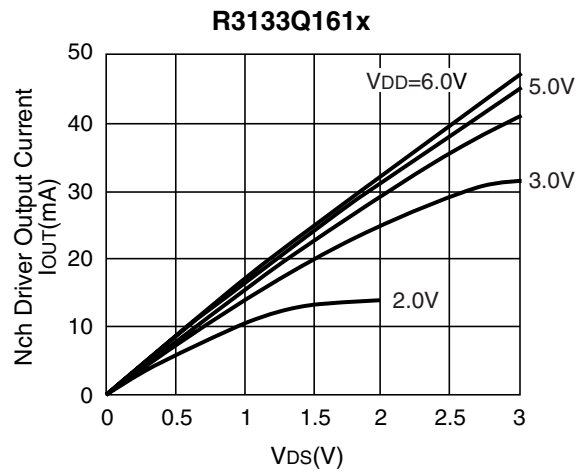
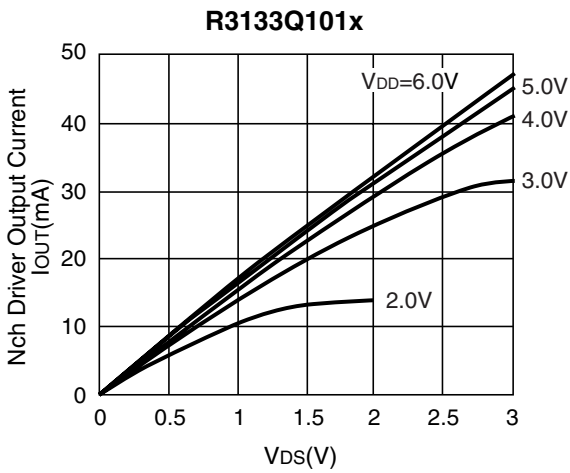
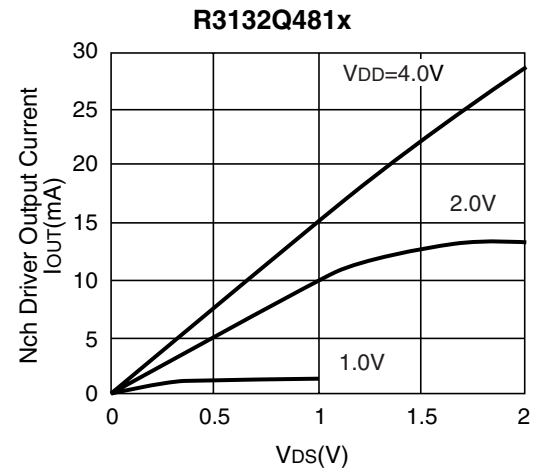
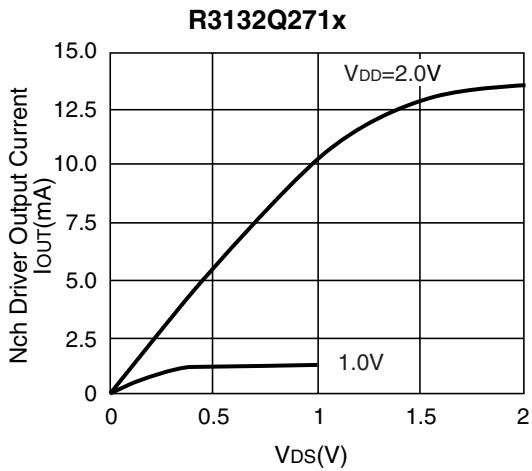
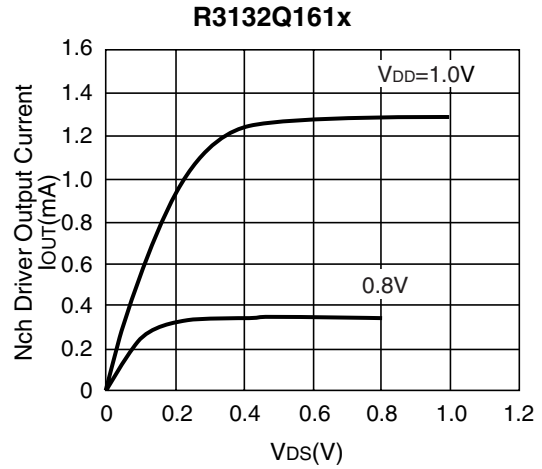
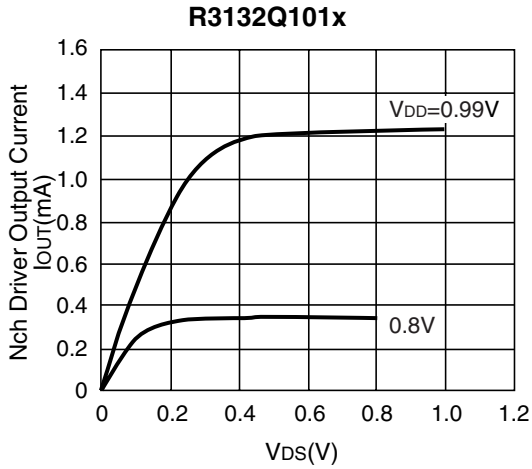

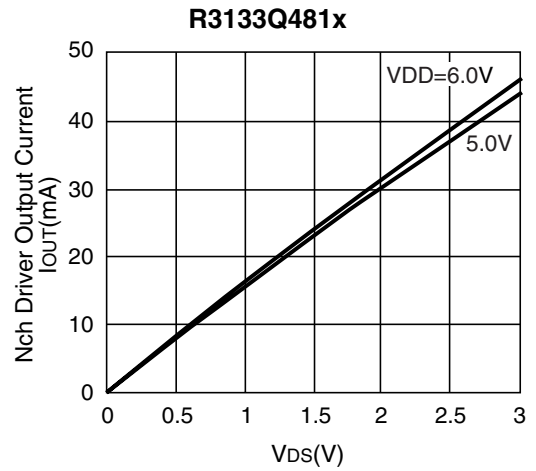
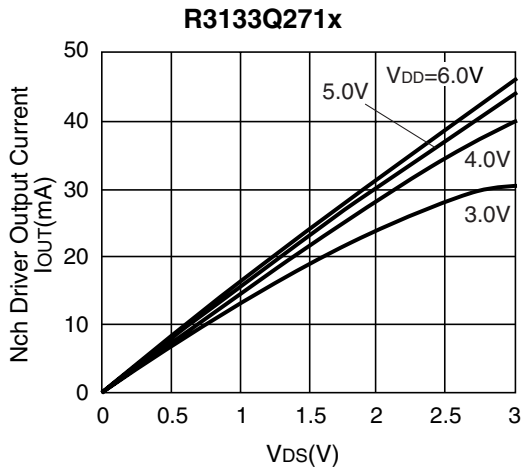

4) Nch Driver Output Current vs. Input Voltage ($V_{BS}=0.5V$)

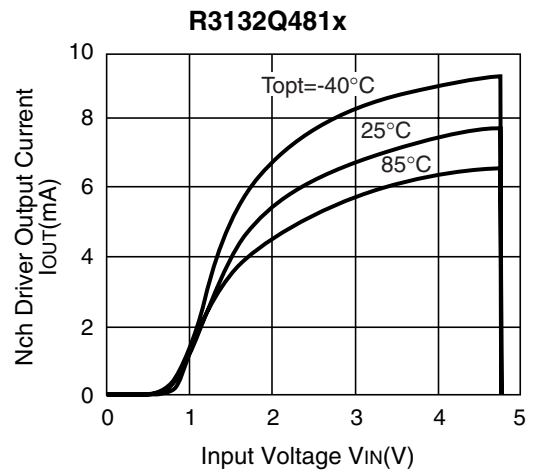
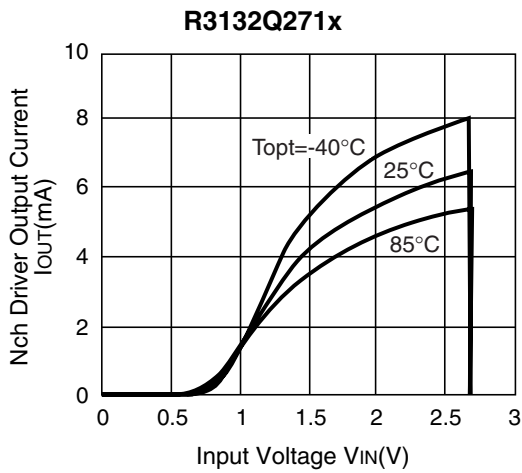
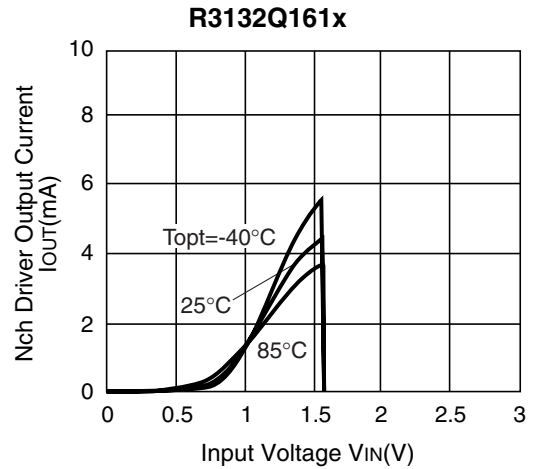
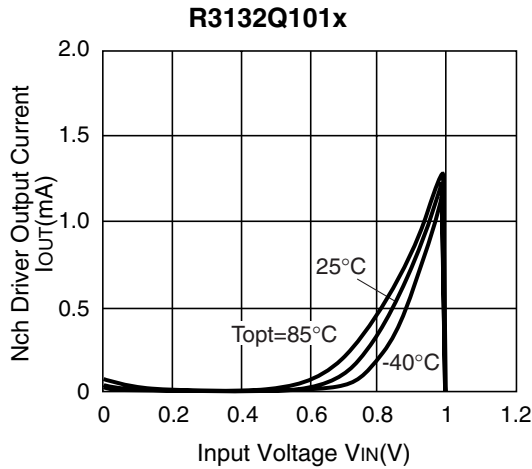

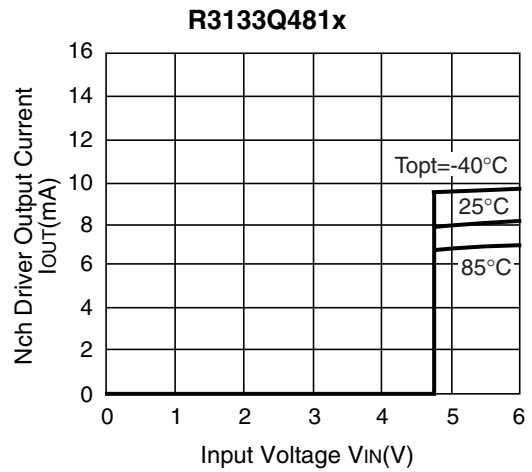
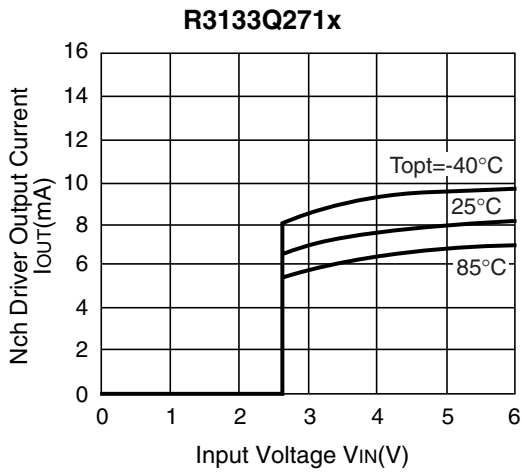
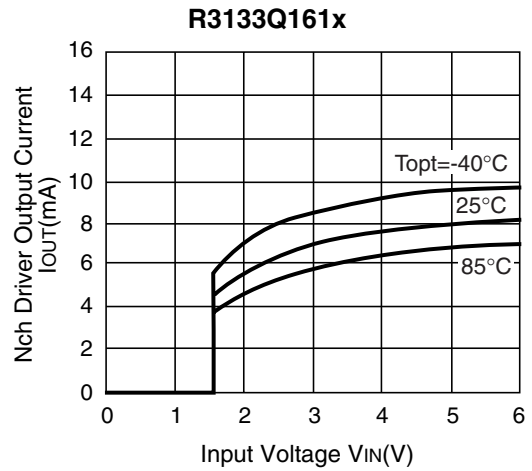
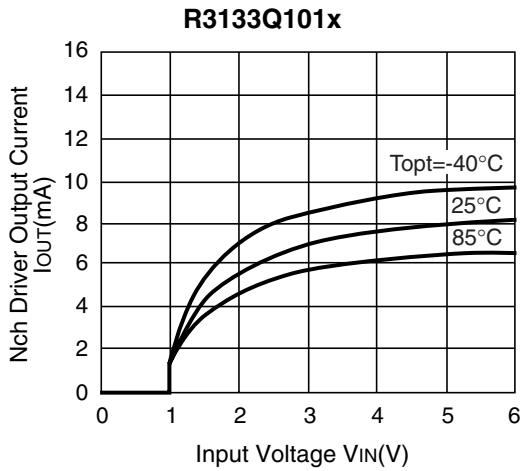

5) Pch Driver Output Current vs. Input Voltage

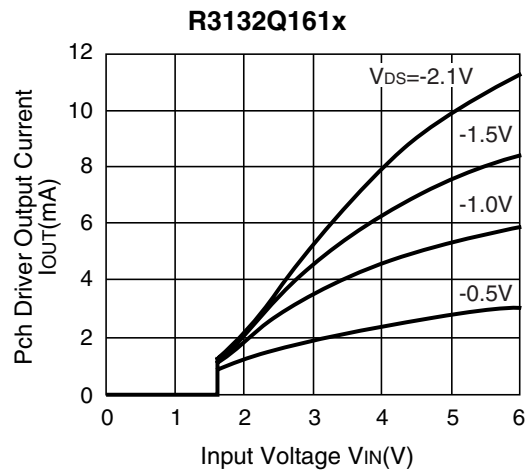
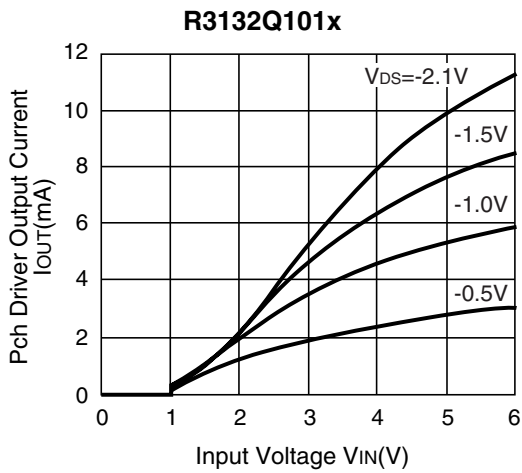

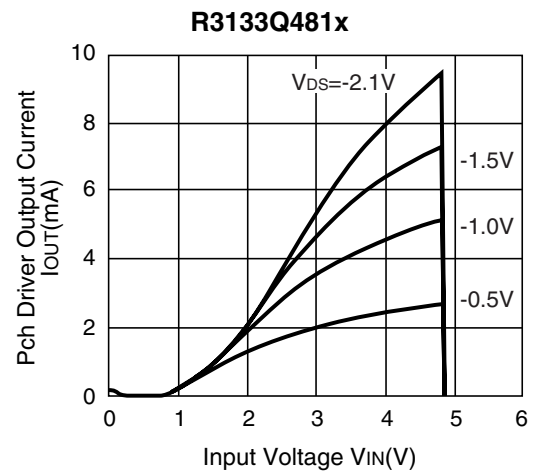
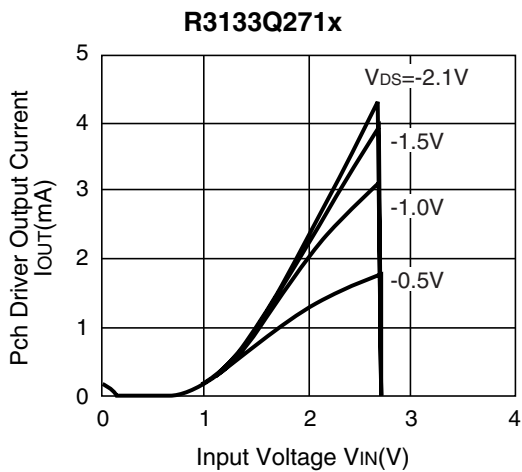
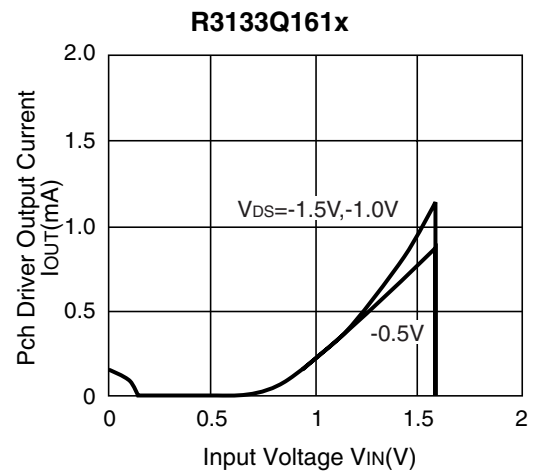
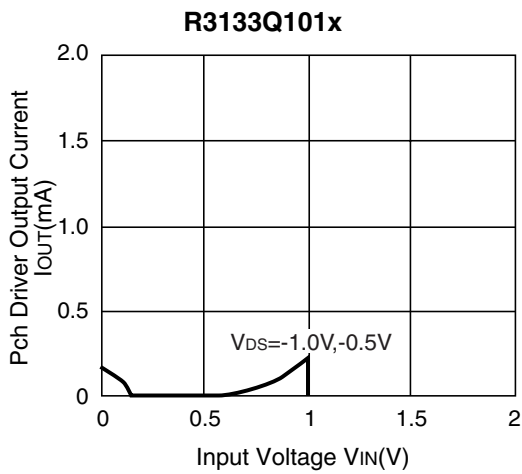
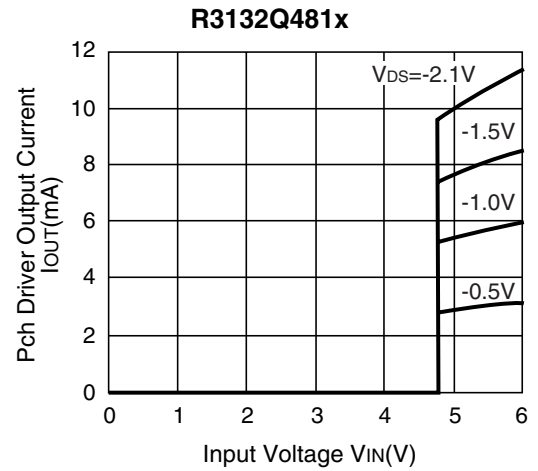
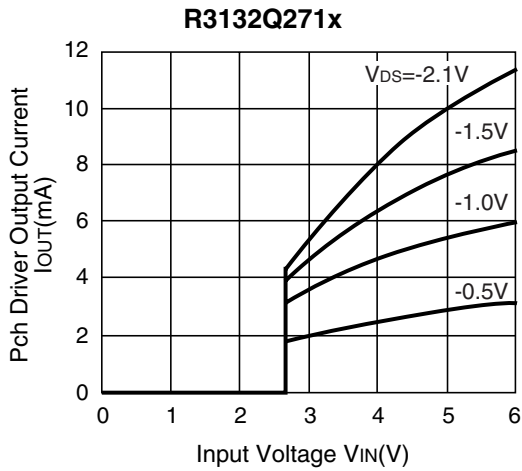

6) Output Delay Time at Detection Mode vs. Temperature

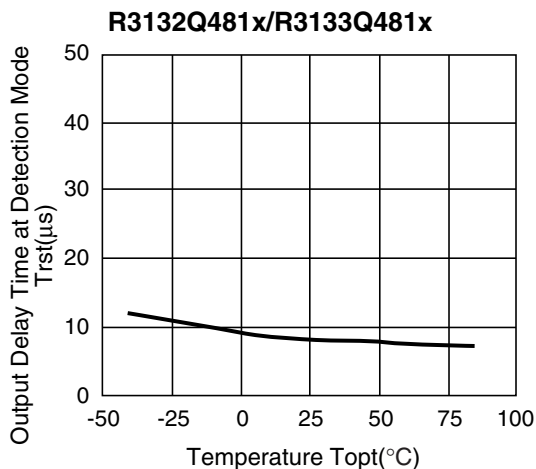
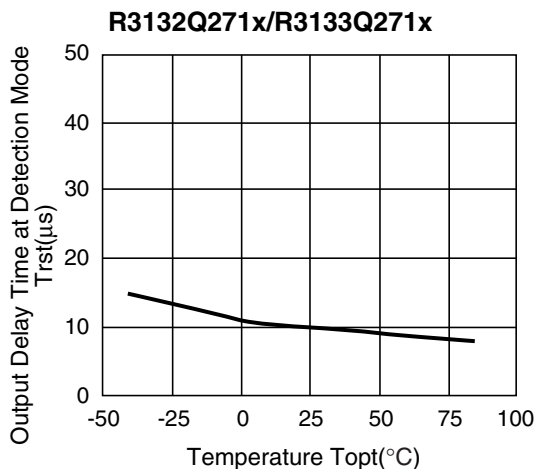
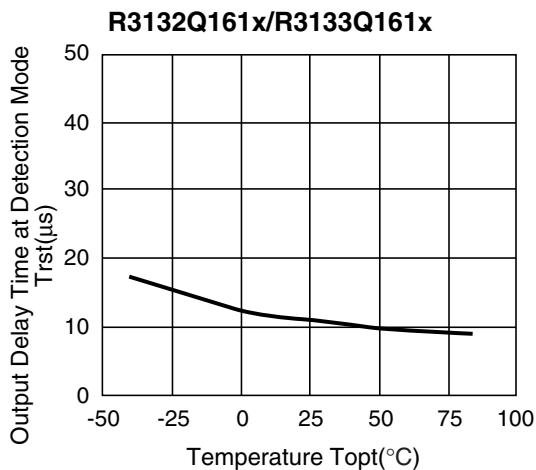
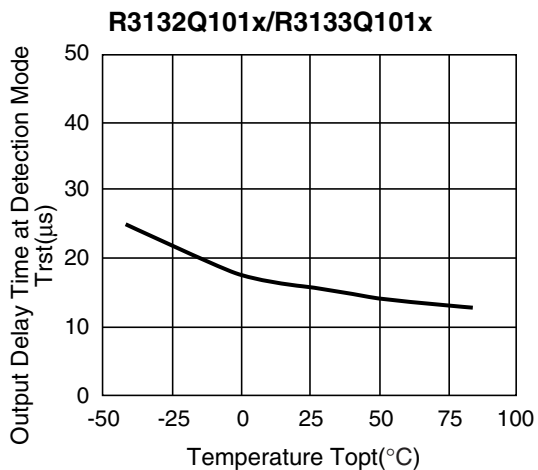

7) Power-on Reset Delay Time vs. Temperature

