

2012 Size

800/850 MHz
Chip Multilayer Coupler

FSLC-S090S-A

All the technical data and information contained herein are subject to change without notice.



LC-FSLC-S090S-A-0406A

Equivalent Circuits

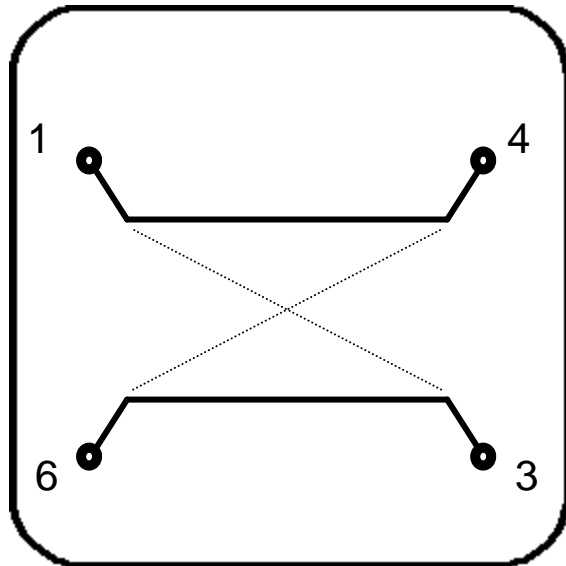

Shape & Size

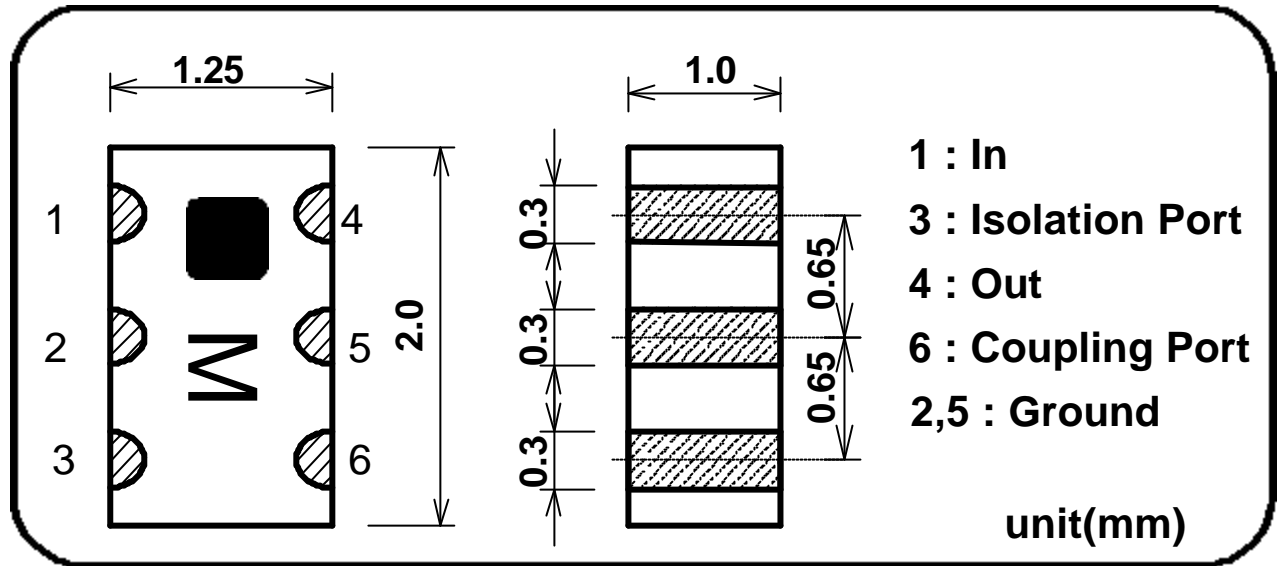

Specifications

Part Name: FSLC-S090S-A

Frequency Range	Coupling	Insertion Loss	Isolation	Return Loss	Handling Power	Temperature Range
800-850MHz	15.5 +/- 1dB	0.5dB Max. (0.25dB Typ.)	24dB Typ.	17dB Min. (22dB Typ.)	1W Max. (CW)	-35 to +85 deg.C

All the technical data and information contained herein are subject to change without notice.

LC-FSLC-S090S-A-0406A

FOOT PATTERN

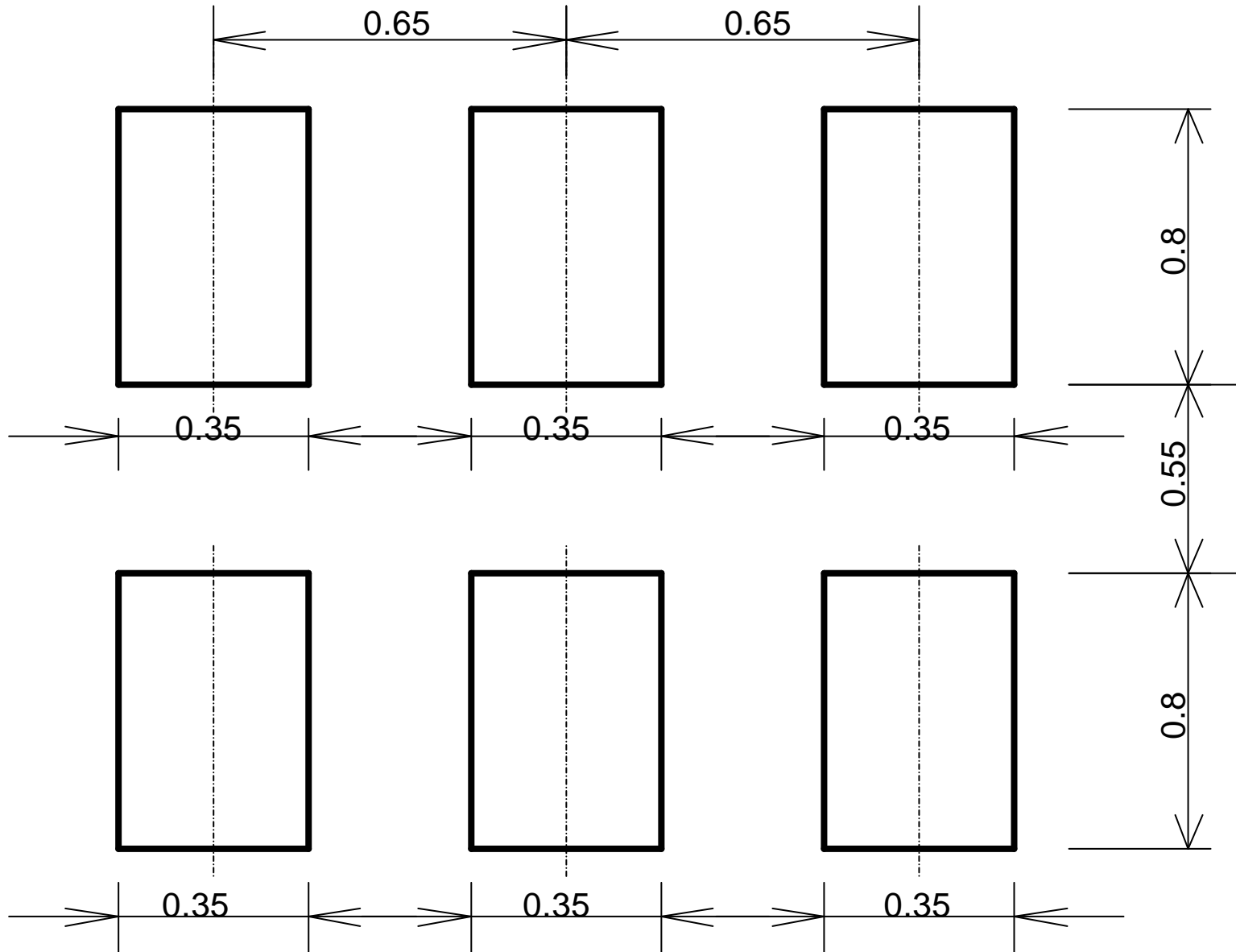

All the technical data and information contained herein are subject to change without notice.

LC-FSLC-S090S-A-0406A

FSLC-S090S-A Sample Data

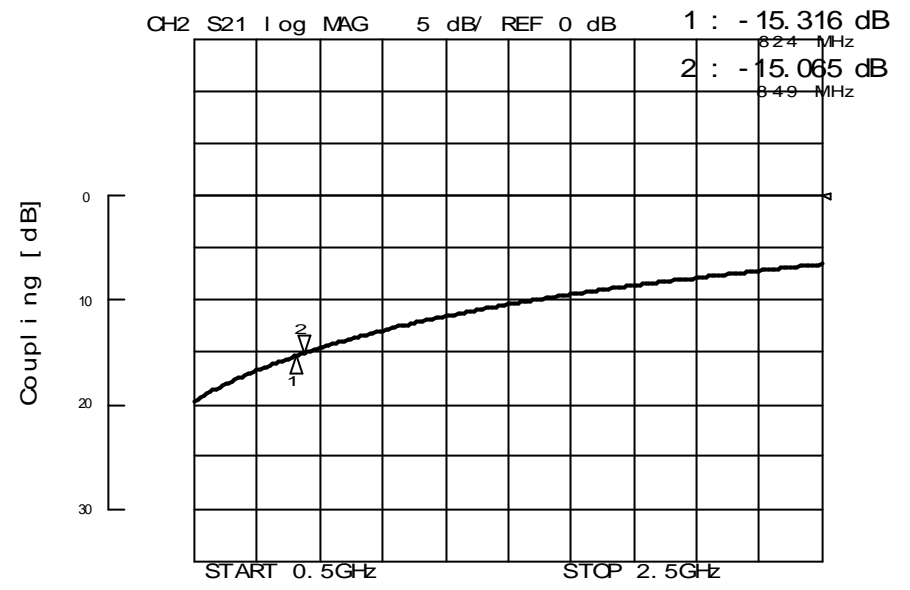
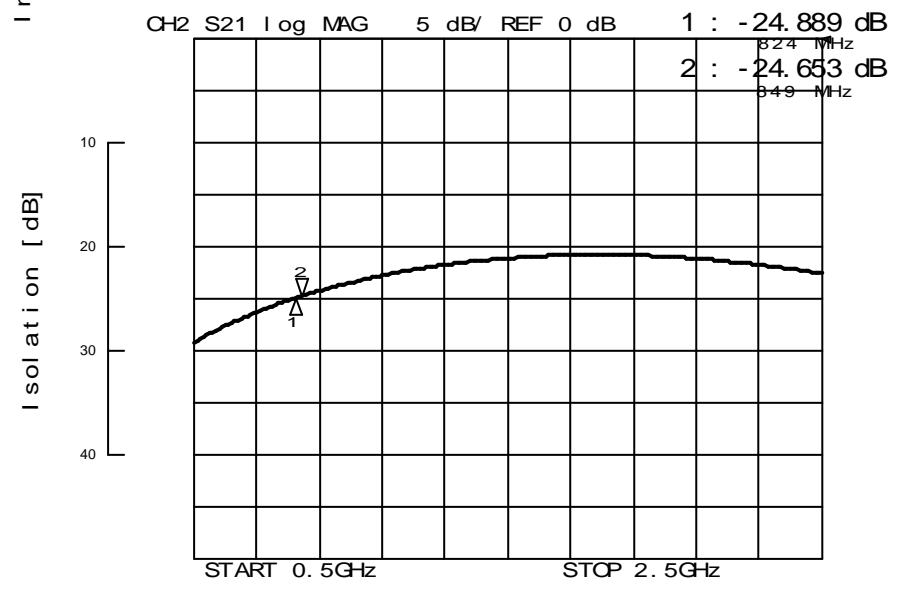
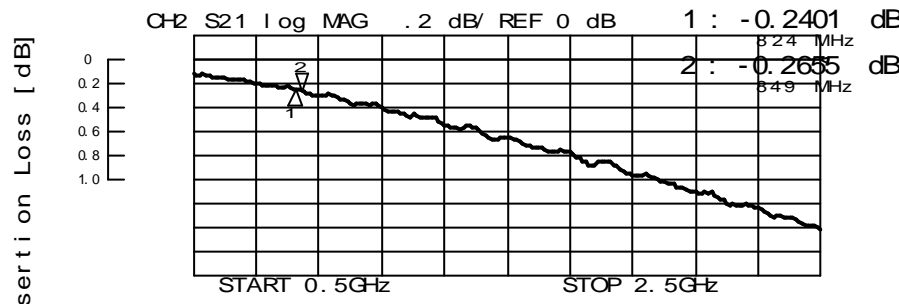
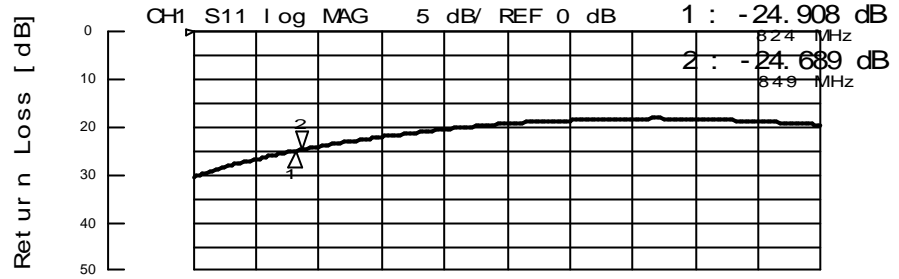

800/850 MHz
Chip Multilayer Coupler "FSLC-S090S-A"

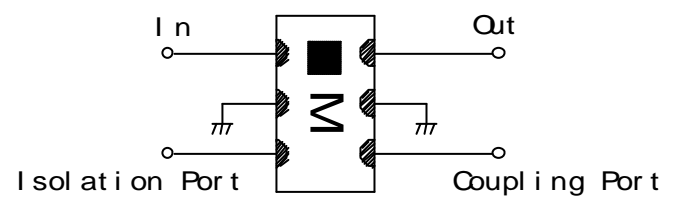

LC-FSLC-S090S-A-0406A