

# NTR4503N

## Power MOSFET

### 30 V, 2.5 A, Single N-Channel, SOT-23

#### Features

- Leading Planar Technology for Low Gate Charge / Fast Switching
- 4.5 V Rated for Low Voltage Gate Drive
- SOT-23 Surface Mount for Small Footprint (3 x 3 mm)
- Pb-Free Package is Available

#### Applications

- DC-DC Conversion
- Load/Power Switch for Portables
- Load/Power Switch for Computing

#### MAXIMUM RATINGS (T<sub>J</sub> = 25°C unless otherwise noted)

Parameter	Symbol	Value	Unit	
Drain-to-Source Voltage	V <sub>DSS</sub>	30	V	
Gate-to-Source Voltage	V <sub>GS</sub>	±20	V	
Continuous Drain Current (Note 1)	Steady State	T <sub>A</sub> = 25°C	I <sub>D</sub> = 2.0	A
		T <sub>A</sub> = 85°C	1.5	
		t ≤ 10 s	T <sub>A</sub> = 25°C	
Power Dissipation (Note 1)	Steady State	T <sub>A</sub> = 25°C	P <sub>D</sub> = 0.73	W
Continuous Drain Current (Note 2)	Steady State	T <sub>A</sub> = 25°C	I <sub>D</sub> = 1.5	A
		T <sub>A</sub> = 85°C	1.1	
Power Dissipation (Note 2)		T <sub>A</sub> = 25°C	P <sub>D</sub> = 0.42	W
Pulsed Drain Current	t <sub>p</sub> = 10 μs	I <sub>DM</sub>	6.0	A
ESD Capability (Note 3)	C = 100 pF, RS = 1500 Ω	ESD	125	V
Operating Junction and Storage Temperature	T <sub>J</sub> , T <sub>stg</sub>	-55 to 150	°C	
Source Current (Body Diode)	I <sub>S</sub>	2.0	A	
Lead Temperature for Soldering Purposes (1/8" from case for 10 s)	T <sub>L</sub>	260	°C	

Maximum ratings are those values beyond which device damage can occur. Maximum ratings applied to the device are individual stress limit values (not normal operating conditions) and are not valid simultaneously. If these limits are exceeded, device functional operation is not implied, damage may occur and reliability may be affected.

#### THERMAL RESISTANCE RATINGS

Parameter	Symbol	Max	Unit
Junction-to-Ambient – Steady State (Note 1)	R <sub>θJA</sub>	170	°C/W
Junction-to-Ambient – t < 10 s (Note 1)	R <sub>θJA</sub>	100	
Junction-to-Ambient – Steady State (Note 2)	R <sub>θJA</sub>	300	

1. Surface-mounted on FR4 board using 1 in sq pad size.
2. Surface-mounted on FR4 board using the minimum recommended pad size.
3. ESD Rating Information: HBM Class 0.



ON Semiconductor®

<http://onsemi.com>

V <sub>(BR)DSS</sub>	R <sub>DS(on)</sub> TYP	I <sub>D</sub> MAX
30 V	85 mΩ @ 10 V	2.5 A
	105 mΩ @ 4.5 V	

#### N-Channel

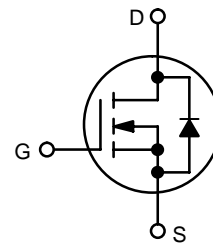

#### MARKING DIAGRAM/ PIN ASSIGNMENT

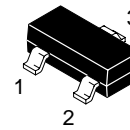

SOT-23  
CASE 318  
STYLE 21

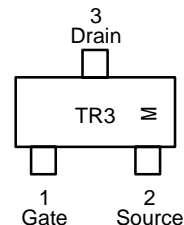

TR3 = Specific Device Code  
M = Date Code

#### ORDERING INFORMATION

Device	Package	Shipping†
NTR4503NT1	SOT-23	3000/Tape & Reel
NTR4503NT1G	SOT-23 (Pb-Free)	3000/Tape & Reel
NTR4503NT3G	SOT-23 (Pb-Free)	10000/Tape & Reel

†For information on tape and reel specifications, including part orientation and tape sizes, please refer to our Tape and Reel Packaging Specification Brochure, BRD8011/D.

# NTR4503N

## ELECTRICAL CHARACTERISTICS (T<sub>J</sub> = 25°C unless otherwise noted)

Parameter	Symbol	Test Conditions	Min	Typ	Max	Units
-----------	--------	-----------------	-----	-----	-----	-------

### OFF CHARACTERISTICS

Drain-to-Source Breakdown Voltage	V <sub>(BR)DSS</sub>	V <sub>GS</sub> = 0 V, I <sub>D</sub> = 250 μA	30	36		V
Zero Gate Voltage Drain Current	I <sub>DSS</sub>	V <sub>GS</sub> = 0 V, V <sub>DS</sub> = 24 V			1.0	μA
		V <sub>GS</sub> = 0 V, V <sub>DS</sub> = 24 V, T <sub>J</sub> = 125°C			10	
Gate-to-Source Leakage Current	I <sub>GSS</sub>	V <sub>DS</sub> = 0 V, V <sub>GS</sub> = ±20 V			±100	nA

### ON CHARACTERISTICS (Note 4)

Gate Threshold Voltage	V <sub>GS(TH)</sub>	V <sub>GS</sub> = V <sub>DS</sub> , I <sub>D</sub> = 250 μA	1.0	1.75	3.0	V
Drain-to-Source On-Resistance	R <sub>DS(on)</sub>	V <sub>GS</sub> = 10 V, I <sub>D</sub> = 2.5 A		85	110	mΩ
		V <sub>GS</sub> = 4.5 V, I <sub>D</sub> = 2.0 A		105	140	
Forward Transconductance	g <sub>FS</sub>	V <sub>DS</sub> = 4.5 V, I <sub>D</sub> = 2.5 A		5.3		S

### CHARGES AND CAPACITANCES

Input Capacitance	C <sub>iss</sub>	V <sub>GS</sub> = 0 V, f = 1.0 MHz, V <sub>DS</sub> = 15 V		135		pF
Output Capacitance	C <sub>oss</sub>			52		
Reverse Transfer Capacitance	C <sub>rss</sub>			15		
Input Capacitance	C <sub>iss</sub>	V <sub>GS</sub> = 0 V, f = 1.0 MHz, V <sub>DS</sub> = 24 V		130	250	pF
Output Capacitance	C <sub>oss</sub>			42	75	
Reverse Transfer Capacitance	C <sub>rss</sub>			13	25	
Total Gate Charge	Q <sub>G(TOT)</sub>	V <sub>GS</sub> = 10 V, V <sub>DS</sub> = 15 V, I <sub>D</sub> = 2.5 A		3.6	7.0	nC
Threshold Gate Charge	Q <sub>G(TH)</sub>			0.3		
Gate-to-Source Charge	Q <sub>GS</sub>			0.6		
Gate-to-Drain Charge	Q <sub>GD</sub>			0.7		
Total Gate Charge	Q <sub>G(TOT)</sub>	V <sub>GS</sub> = 4.5 V, V <sub>DS</sub> = 24 V, I <sub>D</sub> = 2.5 A		1.9		nC
Threshold Gate Charge	Q <sub>G(TH)</sub>			0.3		
Gate-to-Source Charge	Q <sub>GS</sub>			0.6		
Gate-to-Drain Charge	Q <sub>GD</sub>			0.9		

### SWITCHING CHARACTERISTICS (Note 5)

Turn-On Delay Time	t <sub>d(on)</sub>	V <sub>GS</sub> = 10 V, V <sub>DD</sub> = 15 V, I <sub>D</sub> = 1 A, R <sub>G</sub> = 6 Ω		5.8	12	ns
Rise Time	t <sub>r</sub>			5.8	10	
Turn-Off Delay Time	t <sub>d(off)</sub>			14	25	
Fall Time	t <sub>f</sub>			1.6	5.0	
Turn-On Delay Time	t <sub>d(on)</sub>	V <sub>GS</sub> = 10 V, V <sub>DD</sub> = 24 V, I <sub>D</sub> = 2.5 A, R <sub>G</sub> = 2.5 Ω		4.8		ns
Rise Time	t <sub>r</sub>			6.7		
Turn-Off Delay Time	t <sub>d(off)</sub>			13.6		
Fall Time	t <sub>f</sub>			1.8		

### DRAIN-SOURCE DIODE CHARACTERISTICS

Forward Diode Voltage	V <sub>SD</sub>	V <sub>GS</sub> = 0 V, I <sub>S</sub> = 2.0 A		0.85	1.2	V
Reverse Recovery Time	t <sub>RR</sub>	V <sub>GS</sub> = 0 V, I <sub>S</sub> = 2.0 A, dI <sub>S</sub> /dt = 100 A/μs		9.2		ns
Reverse Recovery Charge	Q <sub>RR</sub>			4.0		nC

4. Pulse Test: Pulse Width ≤ 300 μs, Duty Cycle ≤ 2%.

5. Switching characteristics are independent of operating junction temperatures.

TYPICAL PERFORMANCE CURVES

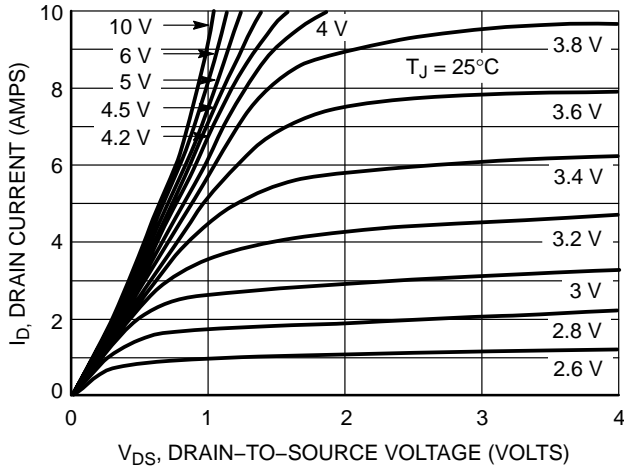

Figure 1. On-Region Characteristics

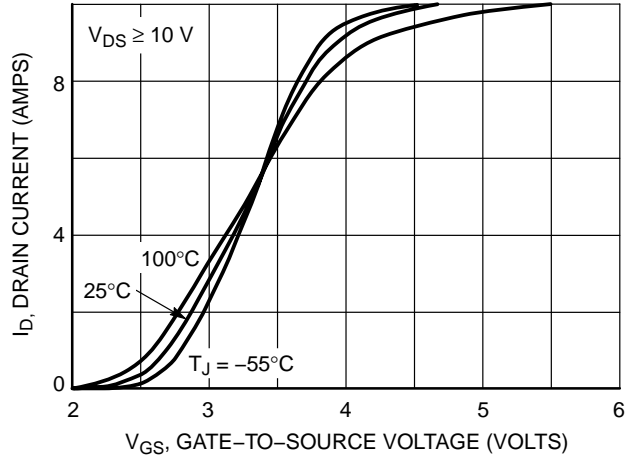

Figure 2. Transfer Characteristics

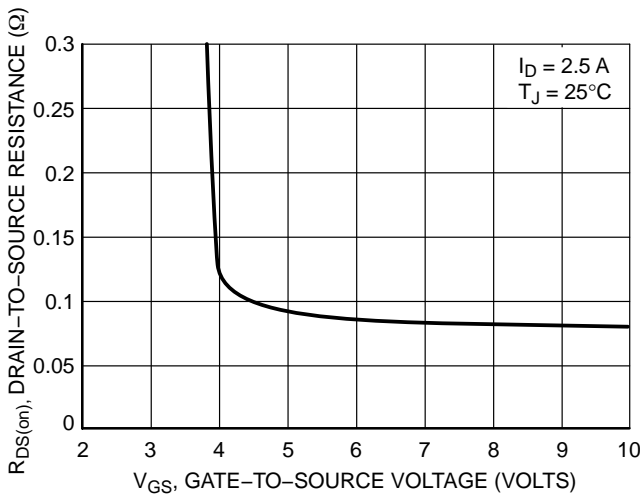

Figure 3. On-Resistance vs. Gate-to-Source Voltage

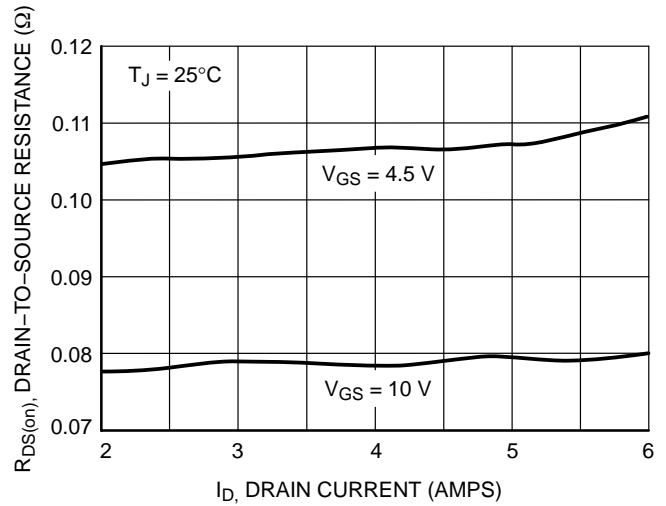

Figure 4. On-Resistance vs. Drain Current and Gate Voltage

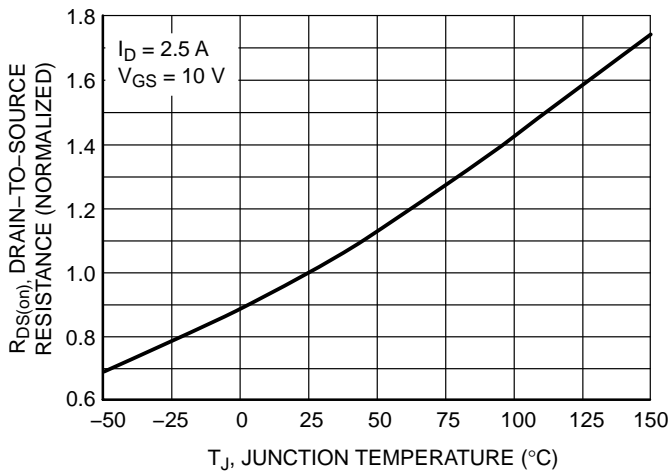

Figure 5. On-Resistance Variation with Temperature

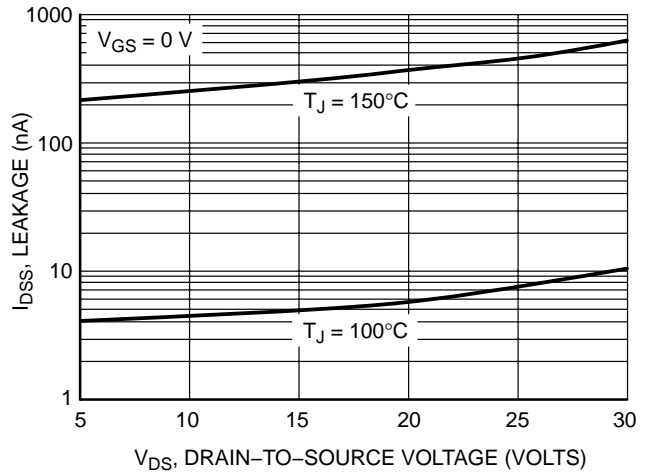

Figure 6. Drain-to-Source Leakage Current vs. Voltage

TYPICAL PERFORMANCE CURVES

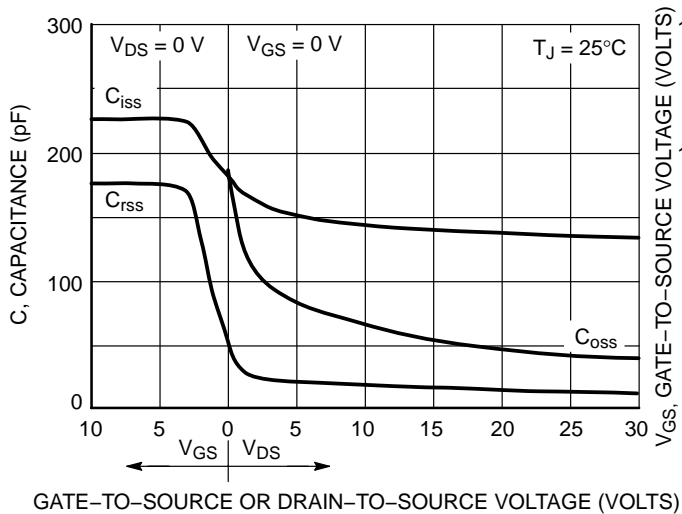

Figure 7. Capacitance Variation

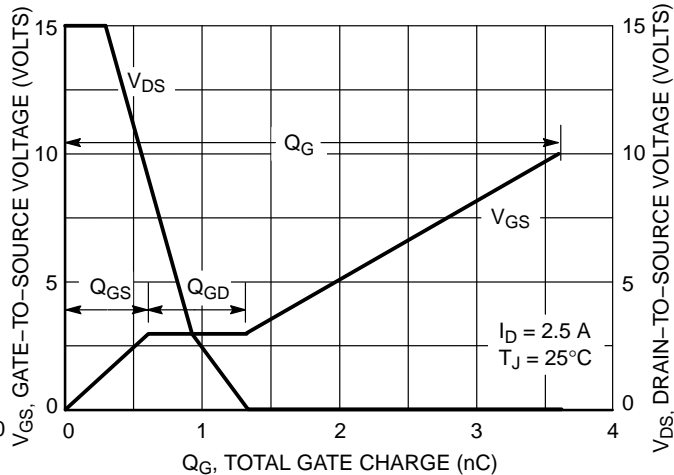

Figure 8. Gate-to-Source and Drain-to-Source Voltage vs. Total Charge

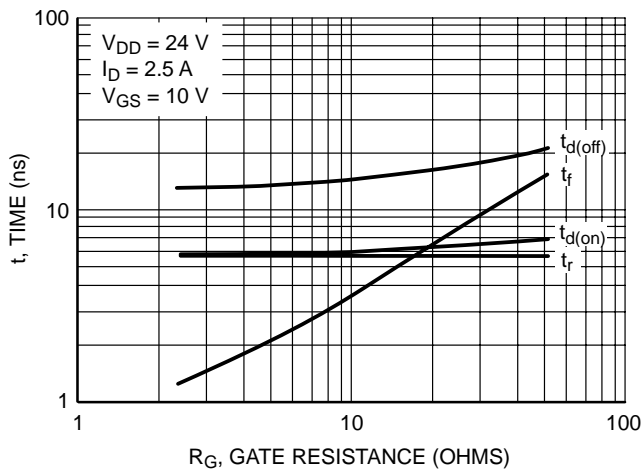

Figure 9. Resistive Switching Time Variation vs. Gate Resistance

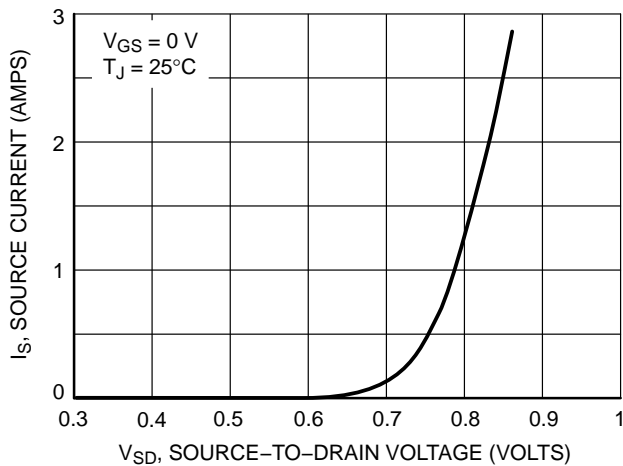
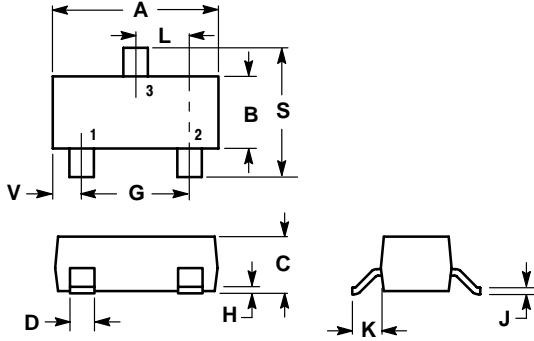

Figure 10. Diode Forward Voltage vs. Current

# NTR4503N

## PACKAGE DIMENSIONS

**SOT-23  
(TO-236)  
CASE 318-08  
ISSUE AK**



**NOTES:**

1. DIMENSIONING AND TOLERANCING PER ANSI Y14.5M, 1982.
2. CONTROLLING DIMENSION: INCH.
3. MAXIMUM LEAD THICKNESS INCLUDES LEAD FINISH THICKNESS. MINIMUM LEAD THICKNESS IS THE MINIMUM THICKNESS OF BASE MATERIAL.
4. 318-01 THRU -07 AND -09 OBSOLETE, NEW STANDARD 318-08.

DIM	INCHES		MILLIMETERS	
	MIN	MAX	MIN	MAX
A	0.1102	0.1197	2.80	3.04
B	0.0472	0.0551	1.20	1.40
C	0.0350	0.0440	0.89	1.11
D	0.0150	0.0200	0.37	0.50
G	0.0701	0.0807	1.78	2.04
H	0.0005	0.0040	0.013	0.100
J	0.0034	0.0070	0.085	0.177
K	0.0140	0.0285	0.35	0.69
L	0.0350	0.0401	0.89	1.02
S	0.0830	0.1039	2.10	2.64
V	0.0177	0.0236	0.45	0.60

**STYLE 21:**

- PIN 1. GATE
2. SOURCE
3. DRAIN

### SOLDERING FOOTPRINT\*

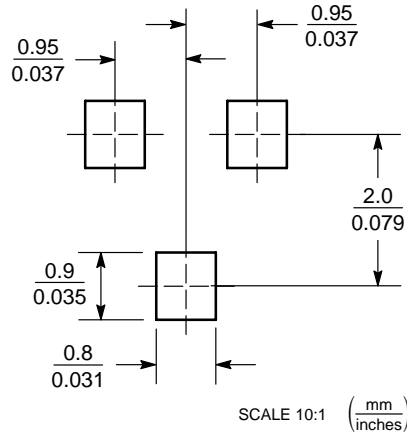

\*For additional information on our Pb-Free strategy and soldering details, please download the ON Semiconductor Soldering and Mounting Techniques Reference Manual, SOLDERRM/D.

# NTR4503N

**ON Semiconductor** and  are registered trademarks of Semiconductor Components Industries, LLC (SCILLC). SCILLC reserves the right to make changes without further notice to any products herein. SCILLC makes no warranty, representation or guarantee regarding the suitability of its products for any particular purpose, nor does SCILLC assume any liability arising out of the application or use of any product or circuit, and specifically disclaims any and all liability, including without limitation special, consequential or incidental damages. "Typical" parameters which may be provided in SCILLC data sheets and/or specifications can and do vary in different applications and actual performance may vary over time. All operating parameters, including "Typicals" must be validated for each customer application by customer's technical experts. SCILLC does not convey any license under its patent rights nor the rights of others. SCILLC products are not designed, intended, or authorized for use as components in systems intended for surgical implant into the body, or other applications intended to support or sustain life, or for any other application in which the failure of the SCILLC product could create a situation where personal injury or death may occur. Should Buyer purchase or use SCILLC products for any such unintended or unauthorized application, Buyer shall indemnify and hold SCILLC and its officers, employees, subsidiaries, affiliates, and distributors harmless against all claims, costs, damages, and expenses, and reasonable attorney fees arising out of, directly or indirectly, any claim of personal injury or death associated with such unintended or unauthorized use, even if such claim alleges that SCILLC was negligent regarding the design or manufacture of the part. SCILLC is an Equal Opportunity/Affirmative Action Employer. This literature is subject to all applicable copyright laws and is not for resale in any manner.

## PUBLICATION ORDERING INFORMATION

### LITERATURE FULFILLMENT:

Literature Distribution Center for ON Semiconductor  
P.O. Box 61312, Phoenix, Arizona 85082-1312 USA  
**Phone:** 480-829-7710 or 800-344-3860 Toll Free USA/Canada  
**Fax:** 480-829-7709 or 800-344-3867 Toll Free USA/Canada  
**Email:** [orderlit@onsemi.com](mailto:orderlit@onsemi.com)

**N. American Technical Support:** 800-282-9855 Toll Free  
USA/Canada

**Japan:** ON Semiconductor, Japan Customer Focus Center  
2-9-1 Kamimeguro, Meguro-ku, Tokyo, Japan 153-0051  
**Phone:** 81-3-5773-3850

**ON Semiconductor Website:** <http://onsemi.com>

**Order Literature:** <http://www.onsemi.com/litorder>

For additional information, please contact your  
local Sales Representative.

**NTR4503N/D**