

# TC7WG125FC

## Dual Bus Buffer with 3-STATE Output

### Features

- High-level output current:  $I_{OH}/I_{OL} = \pm 8 \text{ mA (min)}$   
at  $V_{CC} = 3 \text{ V}$
- High-speed operation:  $t_{pd} = 2.5 \text{ ns (typ.)}$   
at  $V_{CC} = 3.3 \text{ V}, 15\text{pF}$
- Operating voltage range:  $V_{CC} = 0.9\sim 3.6 \text{ V}$
- 5.5-V tolerant inputs
- 3.6-V power down protection outputs

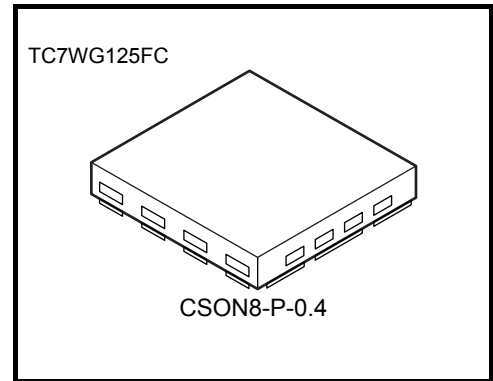

Weight: 0.002 g (typ.)

### Absolute Maximum Ratings (Ta = 25°C)

Characteristics	Symbol	Value	Unit
Power supply voltage	$V_{CC}$	-0.5~4.6	V
DC input voltage	$V_{IN}$	-0.5~7.0	V
DC output voltage	$V_{OUT}$	-0.5~4.6 (Note 1)	V
		-0.5~ $V_{CC} + 0.5$ (Note 2)	
Input diode current	$I_{IK}$	-20	mA
Output diode current	$I_{OK}$	-20 (Note 3)	mA
DC output current	$I_{OUT}$	$\pm 25$	mA
DC $V_{CC}/GND$ current	$I_{CC}$	$\pm 100$	mA
Power dissipation	$P_D$	150 (Note 4)	mW
Storage temperature	$T_{stg}$	-65~150	°C

Note: Using continuously under heavy loads (e.g. the application of high temperature/current/voltage and the significant change in temperature, etc.) may cause this product to decrease in the reliability significantly even if the operating conditions (i.e. operating temperature/current/voltage, etc.) are within the absolute maximum ratings and the operating ranges. Please design the appropriate reliability upon reviewing the Toshiba Semiconductor Reliability Handbook ("Handling Precautions"/Derating Concept and Methods) and individual reliability data (i.e. reliability test report and estimated failure rate, etc).

Note 1:  $V_{CC} = 0 \text{ V}$

Note 2: High or Low State.

$I_{OUT}$  absolute maximum rating must be observed.

Note 3:  $V_{OUT} < GND$

Note 4: Mounted on an FR4 board.

(25.4 mm × 25.4 mm × 1.6 t, Cu Pad: 11.56 mm<sup>2</sup>)

### Marking

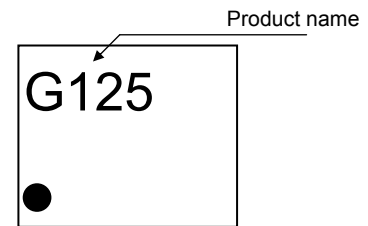

### Pin Assignment ( top view )

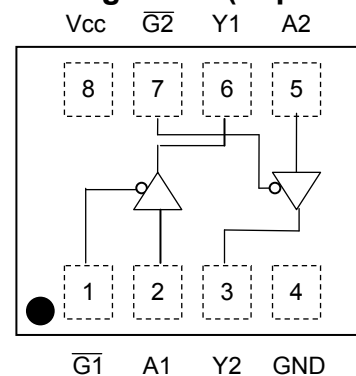

**Truth Table**

Inputs		Outputs
$\overline{G}$	A	Y
H	X	Z
L	L	L
L	H	H

X: Don't Care  
Z: High impedance

**IEC Logic Symbol**

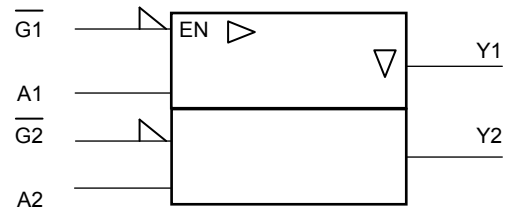

**Operating Ranges**

Characteristics	Symbol	Value	Unit
Power supply voltage	$V_{CC}$	0.9~3.6	V
Input voltage	$V_{IN}$	0~5.5	V
Output voltage	$V_{OUT}$	0~3.6 (Note 5)	V
		0~ $V_{CC}$ (Note 6)	
Output Current	$I_{OH}/I_{OL}$	$\pm 8.0$ (Note 7)	mA
		$\pm 4.0$ (Note 8)	
		$\pm 3.0$ (Note 9)	
		$\pm 1.7$ (Note 10)	
		$\pm 0.3$ (Note 11)	
		$\pm 0.02$ (Note 12)	
Operating temperature	$T_{opr}$	-40~85	$^{\circ}C$
Input rise and fall time	dt/dV	0~10 (Note 13)	ns/V

Note 5:  $V_{CC} = 0\text{ V}$

Note 6: High or Low state.

Note 7:  $V_{CC} = 3.0\sim 3.6\text{ V}$

Note 8:  $V_{CC} = 2.3\sim 2.7\text{ V}$

Note 9:  $V_{CC} = 1.65\sim 1.95\text{ V}$

Note 10:  $V_{CC} = 1.4\sim 1.6\text{ V}$

Note 11:  $V_{CC} = 1.1\sim 1.3\text{ V}$

Note 12:  $V_{CC} = 0.9\text{ V}$

Note 13:  $V_{IN} = 0.8\sim 2.0\text{ V}$ ,  $V_{CC} = 3.0\text{ V}$

## Electrical Characteristics

### DC Characteristics

Characteristics	Symbol	Test Condition	Ta = 25°C			Ta = -40~85°C		Unit			
			V <sub>CC</sub> (V)	Min	Typ.	Max	Min		Max		
Input voltage	High level	V <sub>IH</sub>	—	0.9	V <sub>CC</sub>	—	—	V <sub>CC</sub>	—	V	
				1.1~1.3	V <sub>CC</sub> × 0.7	—	—	V <sub>CC</sub> × 0.7	—		
				1.4~1.6	V <sub>CC</sub> × 0.65	—	—	V <sub>CC</sub> × 0.65	—		
				1.65~1.95	V <sub>CC</sub> × 0.65	—	—	V <sub>CC</sub> × 0.65	—		
				2.3~2.7	1.7	—	—	1.7	—		
				3.0~3.6	2.0	—	—	2.0	—		
	Low level	V <sub>IL</sub>	—	0.9	—	—	GND	—	GND		
				1.1~1.3	—	—	V <sub>CC</sub> × 0.3	—	V <sub>CC</sub> × 0.3		
				1.4~1.6	—	—	V <sub>CC</sub> × 0.35	—	V <sub>CC</sub> × 0.35		
				1.65~1.95	—	—	V <sub>CC</sub> × 0.35	—	V <sub>CC</sub> × 0.35		
				2.3~2.7	—	—	0.7	—	0.7		
				3.0~3.6	—	—	0.8	—	0.8		
Output voltage	High level	V <sub>OH</sub>	V <sub>IN</sub> = V <sub>IL</sub> or V <sub>IH</sub>	I <sub>OH</sub> = -0.02 mA	0.9	0.75	—	—	0.75	—	V
				I <sub>OH</sub> = -0.3 mA	1.1~1.3	V <sub>CC</sub> × 0.75	—	—	V <sub>CC</sub> × 0.75	—	
				I <sub>OH</sub> = -1.7 mA	1.4~1.6	V <sub>CC</sub> × 0.75	—	—	V <sub>CC</sub> × 0.75	—	
				I <sub>OH</sub> = -3.0 mA	1.65~1.95	V <sub>CC</sub> - 0.45	—	—	V <sub>CC</sub> - 0.45	—	
				I <sub>OH</sub> = -4.0 mA	2.3~2.7	2.0	—	—	2.0	—	
				I <sub>OH</sub> = -8.0 mA	3.0~3.6	2.48	—	—	2.48	—	
	Low level	V <sub>OL</sub>	V <sub>IN</sub> = V <sub>IL</sub>	I <sub>OL</sub> = 0.02 mA	0.9	—	—	0.1	—	0.1	
				I <sub>OL</sub> = 0.3 mA	1.1~1.3	—	—	V <sub>CC</sub> × 0.25	—	V <sub>CC</sub> × 0.25	
				I <sub>OL</sub> = 1.7 mA	1.4~1.6	—	—	V <sub>CC</sub> × 0.25	—	V <sub>CC</sub> × 0.25	
				I <sub>OL</sub> = 3.0 mA	1.65~1.95	—	—	0.45	—	0.45	
				I <sub>OL</sub> = 4.0 mA	2.3~2.7	—	—	0.4	—	0.4	
				I <sub>OL</sub> = 8.0 mA	3.0~3.6	—	—	0.4	—	0.4	
Input leakage current	I <sub>IN</sub>	V <sub>IN</sub> = 0~5.5V	0~3.6	—	—	±0.1	—	±1.0	μA		
3-state output off-state current	I <sub>OZ</sub>	V <sub>IN</sub> = V <sub>IH</sub> or V <sub>IL</sub> V <sub>OUT</sub> = 0~3.6V	0.9~3.6	—	—	1.0	—	10.0	μA		
Power off leakage current	I <sub>OFF</sub>	V <sub>IN</sub> = 5.5V or V <sub>OUT</sub> = 3.6V	0.0	—	—	1.0	—	10.0	μA		
Quiescent supply current	I <sub>CC</sub>	V <sub>IN</sub> = V <sub>CC</sub> or GND	3.6	—	—	1.0	—	10.0	μA		

**AC Characteristics (Input:  $t_r = t_f = 3 \text{ ns}$ )**

Characteristics	Symbol	Test Condition	V <sub>CC</sub> (V)	Ta = 25°C			Ta = -40~85°C		Unit		
				Min	Typ.	Max	Min	Max			
Propagation delay time	t <sub>pLH</sub> t <sub>pHL</sub>	C <sub>L</sub> = 10 pF, R <sub>L</sub> = 1 MΩ	0.9	—	18.3	—	—	—	ns		
			1.1~1.3	—	9.4	18.4	1.0	34.9			
			1.4~1.6	—	5.5	8.5	1.0	10.7			
			1.65~1.95	—	4.2	6.2	1.0	6.7			
			2.3~2.7	—	2.8	3.9	1.0	4.4			
			3.0~3.6	—	2.3	3.1	1.0	3.7			
		C <sub>L</sub> = 15 pF, R <sub>L</sub> = 1 MΩ	0.9	—	21.2	—	—	—			
			1.1~1.3	—	10.7	21.5	1.0	38.0			
			1.4~1.6	—	6.1	9.3	1.0	11.9			
			1.65~1.95	—	4.7	6.9	1.0	7.1			
			2.3~2.7	—	3.1	4.4	1.0	5.0			
			3.0~3.6	—	2.5	3.4	1.0	3.9			
		C <sub>L</sub> = 30 pF, R <sub>L</sub> = 1 MΩ	0.9	—	30.5	—	—	—			
			1.1~1.3	—	14.9	30.0	1.0	58.1			
			1.4~1.6	—	8.2	13.2	1.0	16.6			
			1.65~1.95	—	6.1	9.2	1.0	9.9			
			2.3~2.7	—	4.1	5.7	1.0	6.1			
			3.0~3.6	—	3.4	4.4	1.0	4.8			
	Output enable time	t <sub>pZL</sub> t <sub>pZH</sub>	C <sub>L</sub> = 10 pF, R <sub>L</sub> = 100 kΩ	0.9	—	24.0	—	—		—	ns
				C <sub>L</sub> = 10 pF, R <sub>L</sub> = 5 kΩ	1.1~1.3	—	11.8	22.5		1.0	
			1.4~1.6		—	6.8	10.4	1.0		12.0	
1.65~1.95			—		5.1	7.3	1.0	8.1			
2.3~2.7			—		3.4	4.6	1.0	5.3			
3.0~3.6			—		2.5	3.4	1.0	3.9			
C <sub>L</sub> = 15 pF, R <sub>L</sub> = 100 kΩ			0.9	—	26.6	—	—	—			
			C <sub>L</sub> = 15 pF, R <sub>L</sub> = 5 kΩ	1.1~1.3	—	13.0	25.0	1.0	41.9		
1.4~1.6				—	7.4	11.4	1.0	13.4			
1.65~1.95				—	5.5	7.9	1.0	8.5			
2.3~2.7				—	3.7	4.9	1.0	5.5			
3.0~3.6				—	3.0	4.1	1.0	4.6			
C <sub>L</sub> = 30 pF, R <sub>L</sub> = 100 kΩ			0.9	—	36.4	—	—	—			
			C <sub>L</sub> = 30 pF, R <sub>L</sub> = 5 kΩ	1.1~1.3	—	17.9	35.8	1.0	59.1		
1.4~1.6				—	9.8	15.3	1.0	17.8			
1.65~1.95				—	7.2	10.5	1.0	11.2			
2.3~2.7				—	4.5	5.9	1.0	6.6			
3.0~3.6				—	3.6	4.6	1.0	5.3			

Characteristics	Symbol	Test Condition	Ta = 25°C			Ta = -40~85°C		Unit	
			VCC (V)	Min	Typ.	Max	Min		Max
Output disable time	tpLZ tpHZ	CL = 10 pF, RL = 100 kΩ	0.9	—	168.6	—	—	ns	
		CL = 10 pF, RL = 5 kΩ	1.1~1.3	—	9.5	18.4	1.0		25.2
			1.4~1.6	—	7.5	9.5	1.0		10.6
			1.65~1.95	—	7.1	8.7	1.0		9.6
			2.3~2.7	—	6.8	7.9	1.0		8.8
			3.0~3.6	—	6.5	7.5	1.0		8.4
		CL = 15 pF, RL = 100 kΩ	0.9	—	201.8	—	—		—
		CL = 15 pF, RL = 5 kΩ	1.1~1.3	—	10.5	19.8	1.0		27.6
			1.4~1.6	—	9.0	10.4	1.0		12.3
			1.65~1.95	—	8.5	9.7	1.0		10.6
			2.3~2.7	—	7.9	8.8	1.0		10.3
			3.0~3.6	—	7.6	8.3	1.0		9.5
		CL = 30 pF, RL = 100 kΩ	0.9	—	251.5	—	—		—
		CL = 30 pF, RL = 5 kΩ	1.1~1.3	—	14.1	23.8	1.0		31.9
			1.4~1.6	—	13.5	14.5	1.0		16.0
			1.65~1.95	—	12.7	14.3	1.0		15.0
2.3~2.7	—		12.2	14.1	1.0	14.7			
3.0~3.6	—		11.9	13.8	1.0	14.4			
Input capacitance	CIN	—	3.6	—	3	—	—	pF	
Power dissipation capacitance	CPD	(Note 14)	0.9 ~ 3.6	—	10	—	—	—	pF

Note 14: CPD is defined as the value of the internal equivalent capacitance which is calculated from the operating current consumption without load.

Average operating current can be obtained by the equation:

$$I_{CC} (opr.) = C_{PD} \cdot V_{CC} \cdot f_{IN} + I_{CC}/2$$

**AC Characteristics Measurement Circuit**

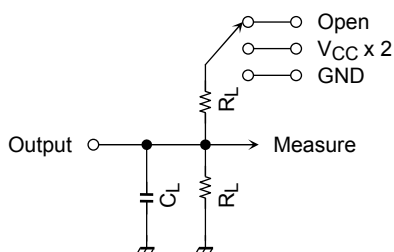

Characteristics	Switch
tpLH, tpHL	Open
tpLZ, tpZL	VCC x 2
tpHZ, tpZH	GND

**Figure1 tpLH, tpHL**

**AC Waveforms**

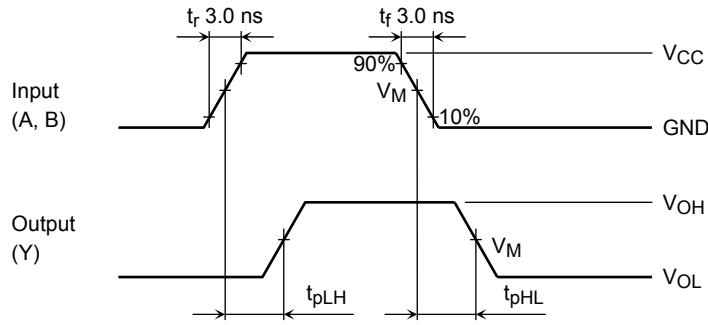

**Figure2  $t_{pLH}$ ,  $t_{pHL}$**

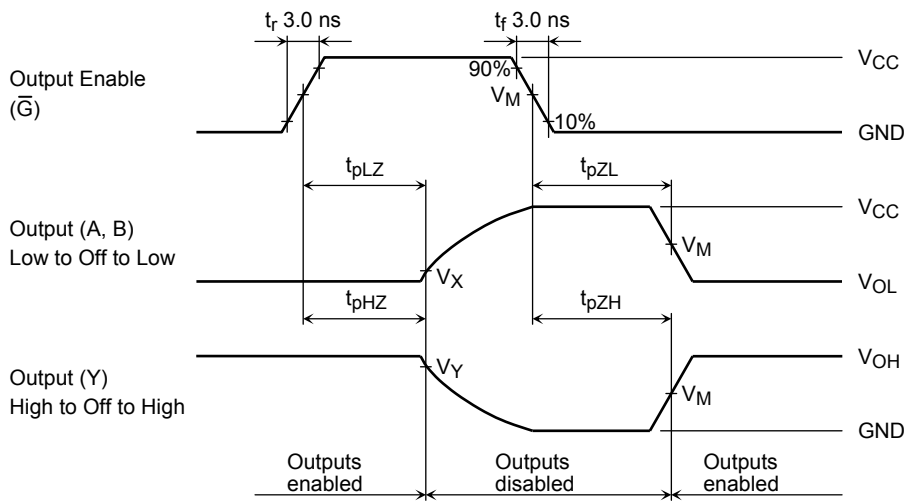

**Figure3  $t_{pLZ}$ ,  $t_{pHZ}$ ,  $t_{pZL}$ ,  $t_{pZH}$**

UNIT	$V_{CC}$					
	$3.3 \pm 0.3 \text{ V}$	$2.5 \pm 0.2 \text{ V}$	$1.8 \pm 0.15 \text{ V}$	$1.5 \pm 0.1 \text{ V}$	$1.2 \pm 0.1 \text{ V}$	$0.9 \text{ V}$
$V_M$	$V_{CC} / 2$	$V_{CC} / 2$	$V_{CC} / 2$	$V_{CC} / 2$	$V_{CC} / 2$	$V_{CC} / 2$
$V_X$	$V_{OL} + 0.3 \text{ V}$	$V_{OL} + 0.15 \text{ V}$	$V_{OL} + 0.15 \text{ V}$	$V_{OL} + 0.1 \text{ V}$	$V_{OL} + 0.1 \text{ V}$	$V_{OL} + 0.1 \text{ V}$
$V_Y$	$V_{OH} - 0.3 \text{ V}$	$V_{OH} - 0.15 \text{ V}$	$V_{OH} - 0.15 \text{ V}$	$V_{OH} - 0.1 \text{ V}$	$V_{OH} - 0.1 \text{ V}$	$V_{OH} - 0.1 \text{ V}$

**Package Dimensions**

CSON8-P-0.4

Unit: mm

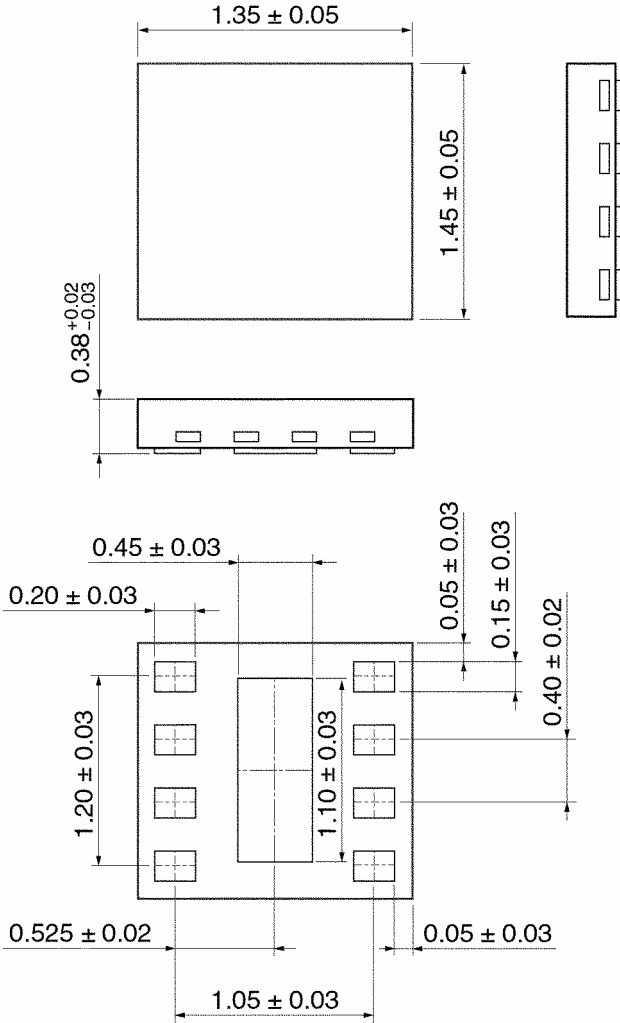

Weight : 0.002 g (Typ.)

**RESTRICTIONS ON PRODUCT USE**

20070701-EN GENERAL

- The information contained herein is subject to change without notice.
- TOSHIBA is continually working to improve the quality and reliability of its products. Nevertheless, semiconductor devices in general can malfunction or fail due to their inherent electrical sensitivity and vulnerability to physical stress. It is the responsibility of the buyer, when utilizing TOSHIBA products, to comply with the standards of safety in making a safe design for the entire system, and to avoid situations in which a malfunction or failure of such TOSHIBA products could cause loss of human life, bodily injury or damage to property.  
In developing your designs, please ensure that TOSHIBA products are used within specified operating ranges as set forth in the most recent TOSHIBA products specifications. Also, please keep in mind the precautions and conditions set forth in the "Handling Guide for Semiconductor Devices," or "TOSHIBA Semiconductor Reliability Handbook" etc.
- The TOSHIBA products listed in this document are intended for usage in general electronics applications (computer, personal equipment, office equipment, measuring equipment, industrial robotics, domestic appliances, etc.). These TOSHIBA products are neither intended nor warranted for usage in equipment that requires extraordinarily high quality and/or reliability or a malfunction or failure of which may cause loss of human life or bodily injury ("Unintended Usage"). Unintended Usage include atomic energy control instruments, airplane or spaceship instruments, transportation instruments, traffic signal instruments, combustion control instruments, medical instruments, all types of safety devices, etc.. Unintended Usage of TOSHIBA products listed in this document shall be made at the customer's own risk.
- The products described in this document shall not be used or embedded to any downstream products of which manufacture, use and/or sale are prohibited under any applicable laws and regulations.
- The information contained herein is presented only as a guide for the applications of our products. No responsibility is assumed by TOSHIBA for any infringements of patents or other rights of the third parties which may result from its use. No license is granted by implication or otherwise under any patents or other rights of TOSHIBA or the third parties.
- Please contact your sales representative for product-by-product details in this document regarding RoHS compatibility. Please use these products in this document in compliance with all applicable laws and regulations that regulate the inclusion or use of controlled substances. Toshiba assumes no liability for damage or losses occurring as a result of noncompliance with applicable laws and regulations.