

TPCL4203

1. Applications

- Dedicated to Single-Cell Lithium-Ion Secondary Battery Applications

Note: The product(s) described herein should not be used for any other application.

2. Features

- (1) Small, thin package
- (2) Low source-source on-resistance: $R_{SS(ON)} = 27 \text{ m}\Omega$ (typ.) ($V_{GS} = 4.5 \text{ V}$)
- (3) Low leakage current: $I_{SSS} = 10 \text{ }\mu\text{A}$ (max) ($V_{SS} = 24 \text{ V}$)
- (4) Enhancement mode: $V_{th} = 0.5 \text{ to } 1.2 \text{ V}$ ($V_{SS} = 10 \text{ V}$, $I_S = 200 \text{ }\mu\text{A}$)
- (5) Common drain

3. Packaging and Internal Circuit

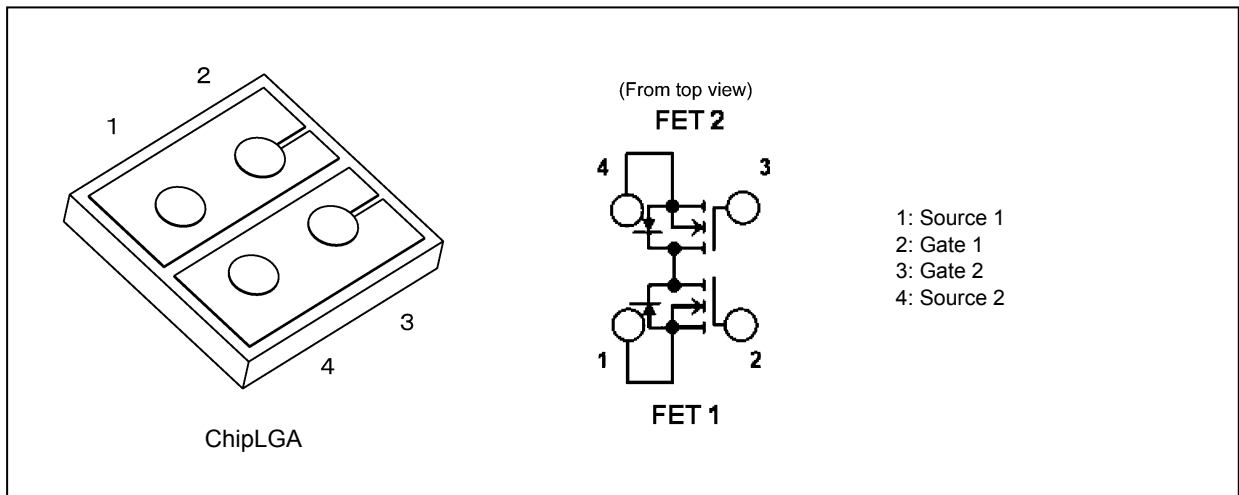

4. Absolute Maximum Ratings (Note) ($T_a = 25^\circ\text{C}$ unless otherwise specified)

Characteristics	Symbol	Rating	Unit
Source-source voltage	V_{SSS}	24	V
Gate-source voltage	V_{GSS}	± 12	
Source current (DC)	I_S	6	A
Source current (pulsed)	I_{SP}	24	
Power dissipation	P_D	0.50	W
Power dissipation	P_D	1.65	W
Channel temperature	T_{ch}	150	$^\circ\text{C}$
Storage temperature	T_{stg}	-55 to 150	

Note: Using continuously under heavy loads (e.g. the application of high temperature/current/voltage and the significant change in temperature, etc.) may cause this product to decrease in the reliability significantly even if the operating conditions (i.e. operating temperature/current/voltage, etc.) are within the absolute maximum ratings.

Please design the appropriate reliability upon reviewing the Toshiba Semiconductor Reliability Handbook ("Handling Precautions"/"Derating Concept and Methods") and individual reliability data (i.e. reliability test report and estimated failure rate, etc).

5. Thermal Characteristics

Characteristics	Symbol	Max	Unit
Channel-to-ambient thermal resistance (t = 10 s) (Note 2), (Note 4)	$R_{th(ch-a)}$	250	°C/W
Channel-to-ambient thermal resistance (t = 10 s) (Note 3), (Note 4)	$R_{th(ch-a)}$	75.8	°C/W

Note 1: Ensure that the channel temperature does not exceed 150°C.

Note 2: Device mounted on a glass-epoxy board (a), Figure 5.1

Note 3: Device mounted on a glass-epoxy board (b), Figure 5.2

Note 4: Equal voltage applied to FET1 and FET2.

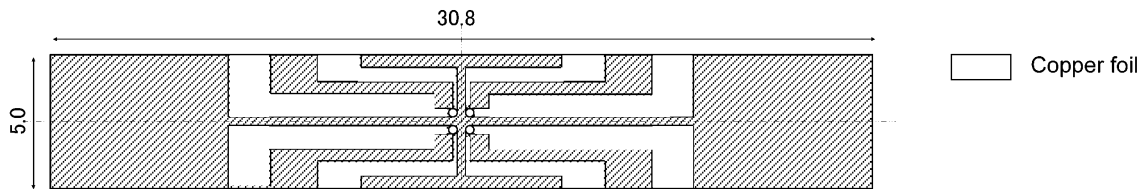

30.8 × 5.0 × 0.6 (Unit: mm)

FR-4 Glass-epoxy board (One-layer)

Fig. 5.1 Device Mounted on a Glass-Epoxy Board (a)

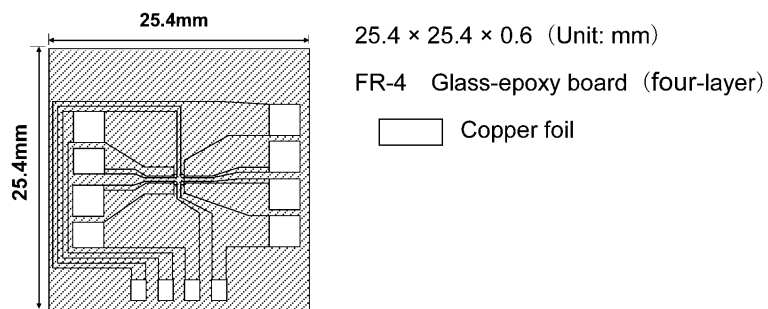

25.4 × 25.4 × 0.6 (Unit: mm)

FR-4 Glass-epoxy board (four-layer)

Fig. 5.2 Device Mounted on a Glass-Epoxy Board (b)

Note: This transistor is sensitive to electrostatic discharge and should be handled with care.

6. Safety Precautions

This section lists important precautions which users of semiconductor devices (and anyone else) should observe in order to avoid injury to human body and damage to property, and to ensure safe and correct use of our products. Please be sure that you understand the meanings of the labels and graphic symbols described below before you move on to the detailed descriptions of the precautions, and comply with the precautions stated.



Explanation of Labels

 WARNING
Indicates a hazardous situation which, if not avoided, could result in death or serious injury ¹ .

Explanation of Graphic Symbols

 Instructions
Indicates actions that must be undertaken for safety purposes.

1: Serious injury includes blindness, wounds, burns (low and high temperature), electric shock, fractures, and poisoning, etc. with long-lasting effects or that require hospitalization and/or long-term hospital visits for treatment.

 WARNING	
 Instructions	<p>【Handling Precaution for Power MOSFET in use of Protection Circuit for Battery Pack】 Use a unit, for example PTC Thermistor, which can shut off the power supply if a short-circuit occurs. If the power supply is not shut off on the occurring short-circuit, a large short-circuit current will flow continuously, which may cause the device to catch fire or smoke. The product listed in this document is intended for usage in Lithium Ion Battery charge and discharge control application. So it is responsible for customer when using the product in the different application.</p>

7. Electrical Characteristics

7.1. Static Characteristics ($T_a = 25^\circ\text{C}$ unless otherwise specified)

Characteristics	Symbol	Test Condition	Min	Typ.	Max	Unit
Gate leakage current (Note 5)	I_{GSS}	$V_{GS} = \pm 12\text{ V}, V_{DS} = 0\text{ V}$	—	—	± 0.1	μA
Source cut-off current (Note 5)	I_{SSS}	$V_{SS} = 24\text{ V}, V_{GS} = 0\text{ V}$	—	—	10	
Source-source breakdown voltage (Note 5)	$V_{(BR)SSS}$	$I_S = 10\text{ mA}, V_{GS} = 0\text{ V}$	24	—	—	V
	$V_{(BR)SSX}$	$I_S = 10\text{ mA}, V_{GS} = -12\text{ V}$	12	—	—	
Gate threshold voltage (Note 5)	V_{th}	$V_{SS} = 10\text{ V}, I_S = 200\ \mu\text{A}$	0.5	—	1.2	
Source-source on-resistance (Note 6)	$R_{SS(ON)}$	$V_{GS} = 2.5\text{ V}, I_S = 3\text{ A}$	30	42	55	m Ω
		$V_{GS} = 3.1\text{ V}, I_S = 3\text{ A}$	26	33	46	
		$V_{GS} = 4.0\text{ V}, I_S = 3\text{ A}$	23	29	38	
		$V_{GS} = 4.5\text{ V}, I_S = 3\text{ A}$	22	27	36	

7.2. Dynamic Characteristics ($T_a = 25^\circ\text{C}$ unless otherwise specified)

Characteristics	Symbol	Test Condition	Min	Typ.	Max	Unit
Input capacitance (Note 5)	C_{iss}	$V_{SS} = 10\text{ V}, V_{GS} = 0\text{ V}, f = 1\text{ MHz}$	—	685	—	μF
Reverse transfer capacitance (Note 5)	C_{rss}		—	100	—	
Output capacitance (Note 5)	C_{oss}		—	145	—	
Switching time (rise time) (Note 5)	t_r	See Figure 7.2.1.	—	85	—	ns
Switching time (turn-on time) (Note 5)	t_{on}		—	120	—	
Switching time (fall time) (Note 5)	t_f		—	210	—	
Switching time (turn-off time) (Note 5)	t_{off}		—	370	—	

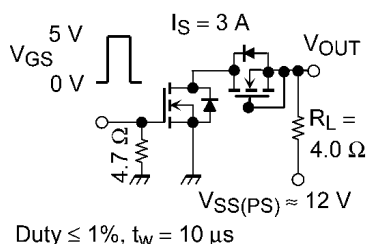

Fig. 7.2.1 Switching Time Test Circuit

7.3. Gate Charge Characteristics ($T_a = 25^\circ\text{C}$ unless otherwise specified)

Characteristics	Symbol	Test Condition	Min	Typ.	Max	Unit
Total gate charge (gate-source plus gate-drain) (Note 5)	Q_g	$V_{SS(PS)} \approx 19\text{ V}, V_{GS} = 5\text{ V}, I_S = 6\text{ A}$	—	10	—	nC
Gate-source charge 1 (Note 5)	Q_{gs1}		—	1.7	—	

7.4. Source-Source Characteristics ($T_a = 25^\circ\text{C}$ unless otherwise specified)

Characteristics	Symbol	Test Condition	Min	Typ.	Max	Unit
Diode forward voltage (Note 7)	V_{SSF}	$I_{SR} = 3\text{ A}, V_{GS} = 0\text{ V}$	—	—	-1.2	V

Note 5: FET1 is measured with the gate and source pins of FET2 shorted. FET2 is measured with the gate and source pins of FET1 shorted.

Note 6: Measured with the indicated gate-to-source voltage (V_{GS}) applied to both FET1 and FET2.

Note 7: FET1 is measured with 4.5 V applied between the gate and source pins of FET2. FET2 is measured with 4.5 V applied between the gate and source pins of FET1.

8. Marking

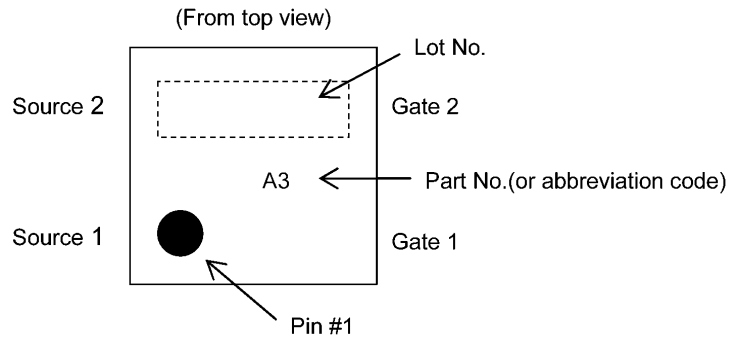

Fig. 8.1 Marking

9. Mounting Condition

This device should be soldered onto a pc board with up to two reflow passes at the recommended reflow conditions. The second reflow process should be performed within two weeks after the first reflow process.

9.1. Using Infrared Reflow

- (1) It is recommended the top and bottom heating method with long or medium infrared rays. (See Figure 9.1.1.)
- (2) Figure 9.1.2 shows the recommended temperature profile for using eutectic solder. Figure 9.1.3 shows the recommended temperature profile for using lead (Pb)-free solder. Complete the infrared ray reflow process with a maximum package surface temperature of 260°C, within 30 to 50 seconds when a package surface temperature is 230°C or higher (See Figure 9.1.3).

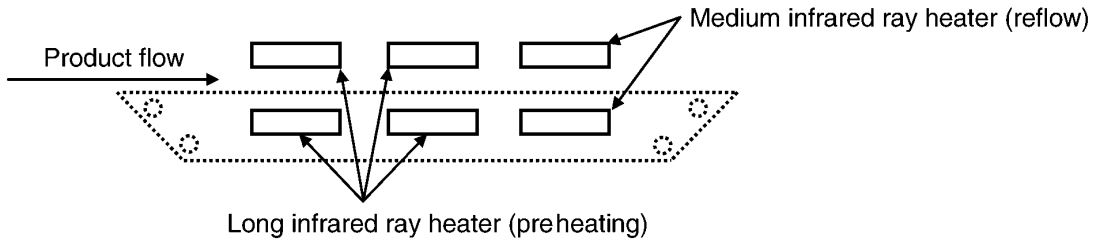

Fig. 9.1.1 Heating the Top and Bottom with Long or Medium Infrared Rays

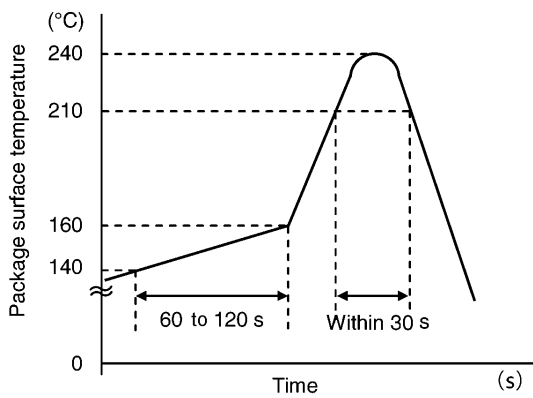

Fig. 9.1.2 Eutectic Recommended Temperature Profile

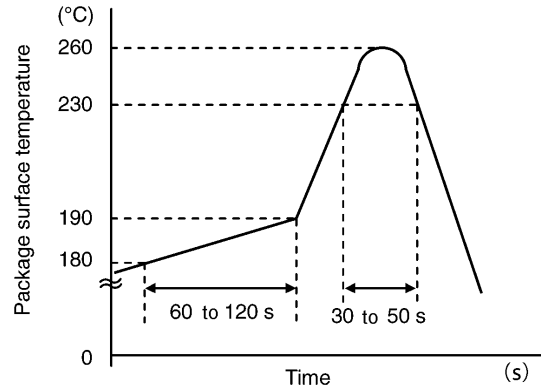

Fig. 9.1.3 Lead (Pb)-Free Recommended Temperature Profile

9.2. Using Hot Air Reflow

For an example of a recommended temperature profile, refer to Figures 9.1.2 and 9.1.3.

9.3. Mechanical Stress

This device is very small and thin. Excessive mechanical stress may damage the package and/or chip. To avoid damage to the device, the distortion factor should be kept below 2000 $\mu\epsilon$ or within the shaded area in Figure 9.3.1. Keep in mind that the stress applied to the device varies, depending on the shape, material, trace patterns, parts layout and other conditions of the pc board. Thus the integrity of the device should be tested on the actual application board. In addition, the end product should provide adequate headroom above the top (marking) side of the device so that no mechanical stress will be applied to it.

The distortion factor (ϵ) is given by:

$$\epsilon = 6 h S / (L \times L), \text{ h: Board thickness, S = Bend, L = Support-to-support distance}$$

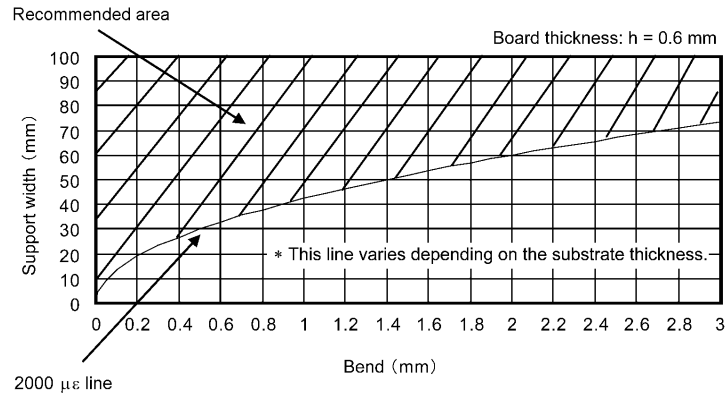

Fig. 9.3.1 Support-to-Support Distance vs. Bending

9.4. Test Method

Test method (reference standard JEITA ED-4702A):

The test board is placed on supports with the device face-down. The supports are placed with a distance of 24 mm as shown in Figure 9.4.1 below. Stress is applied to the test board as shown in Figure 9.4.2.

Test board: FR-4 glass epoxy board measuring 30.8 mm \times 5 mm \times 0.6 mm

A rigid pc board with a thickness of 0.4 mm or more should be used for actual applications.

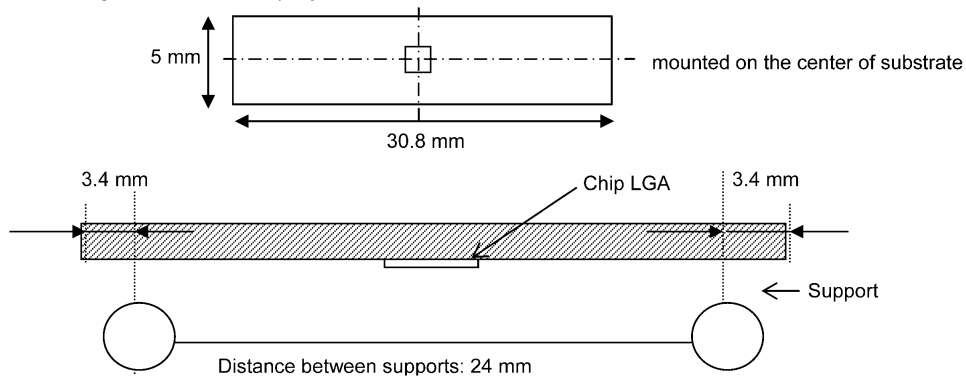

Fig. 9.4.1 Placement

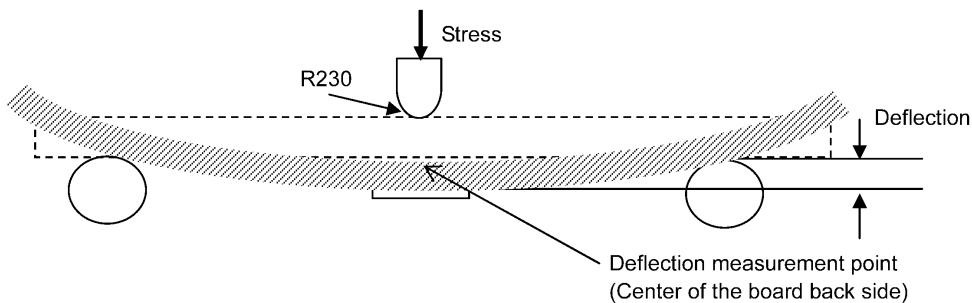

Fig. 9.4.2 During Testing

10. Characteristics Curves (Note)

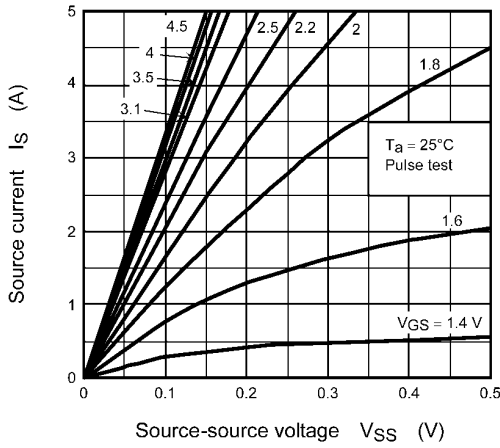

Fig. 10.1 $I_S - V_{SS}$ (Note 6)

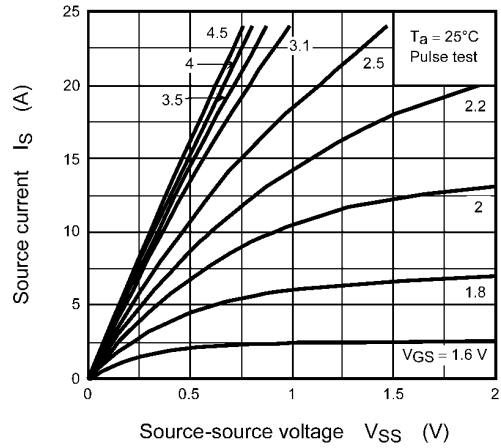

Fig. 10.2 $I_S - V_{SS}$ (Note 6)

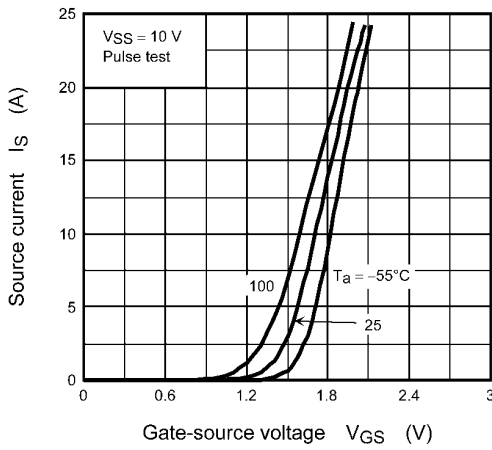

Fig. 10.3 $I_S - V_{GS}$ (Note 5)

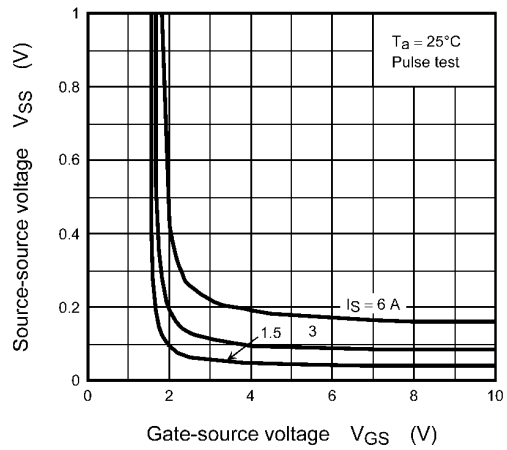

Fig. 10.4 $V_{SS} - V_{GS}$ (Note 6)

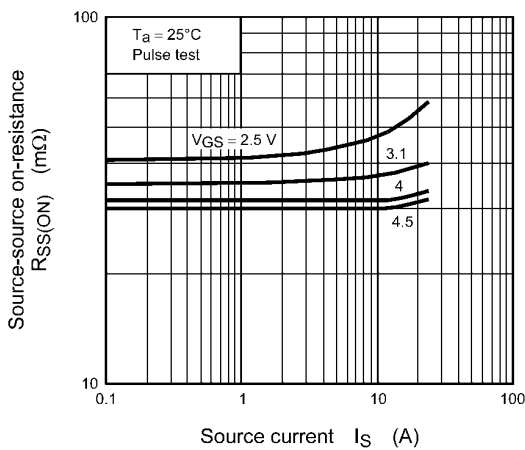

Fig. 10.5 $R_{SS(ON)} - I_S$ (Note 6)

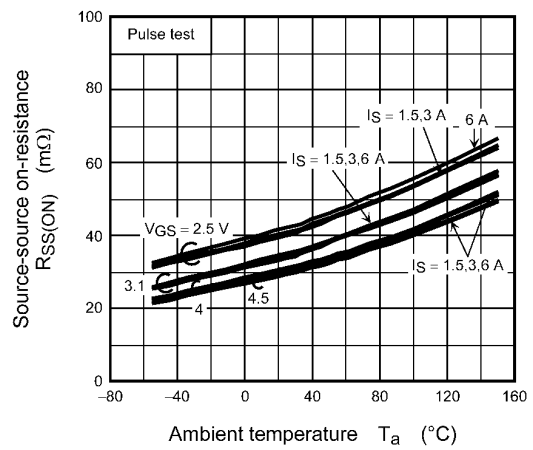

Fig. 10.6 $R_{SS(ON)} - T_a$ (Note 6)

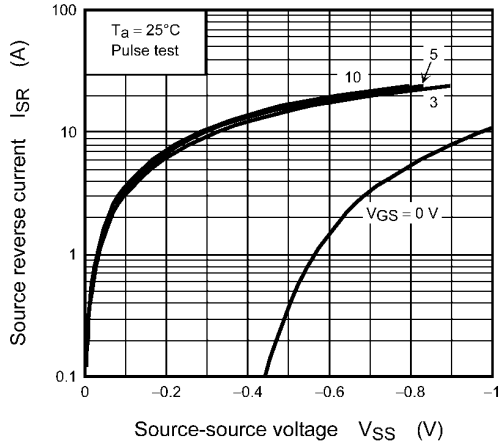

Fig. 10.7 $I_{SR} - V_{SS}$ (Note 7)

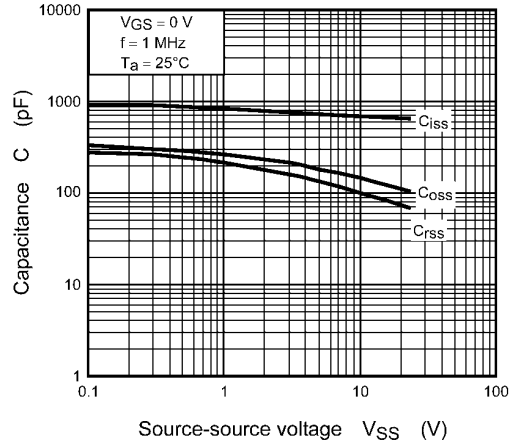

Fig. 10.8 Capacitance - V_{SS} (Note 5)

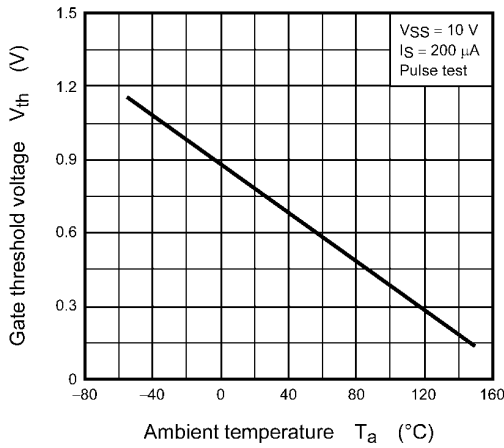

Fig. 10.9 $V_{th} - T_a$ (Note 5)

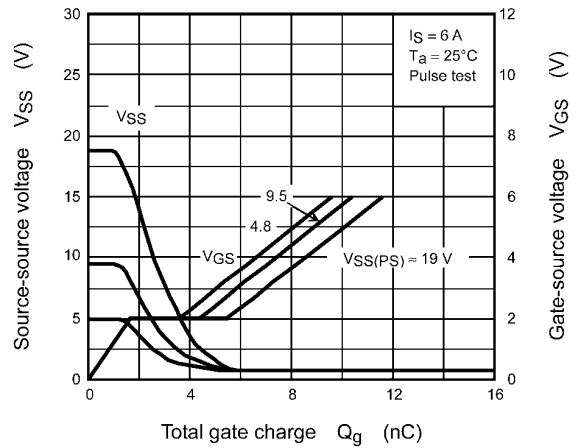

Fig. 10.10 Dynamic Input/Output Characteristics (Note 5)

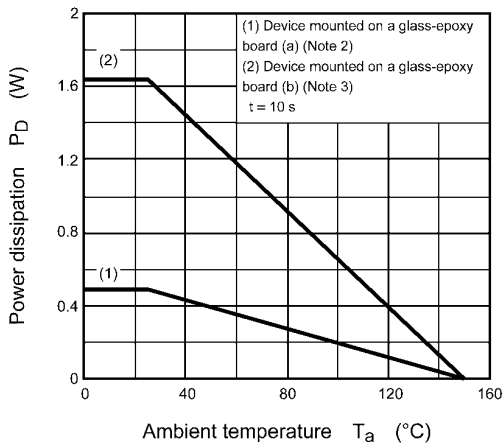

Fig. 10.11 $P_D - T_a$ (Note 4)
(Guaranteed Maximum)

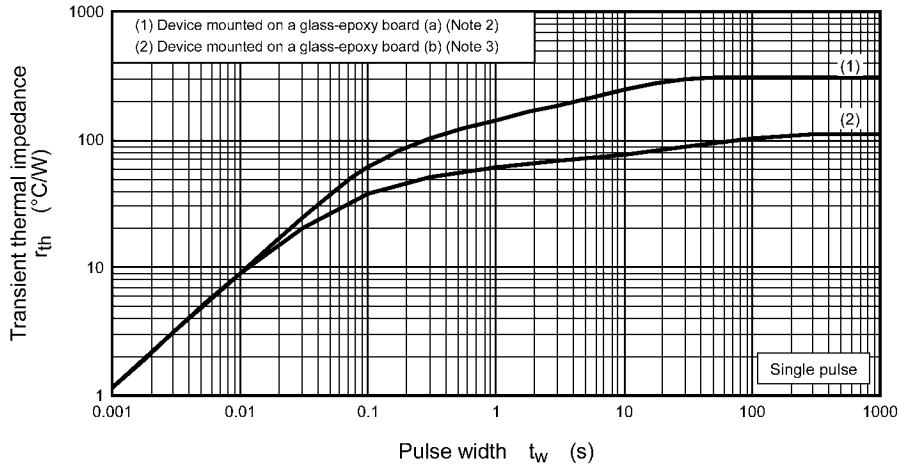

Fig. 10.12 $r_{th} - t_w$ (Note 4)
(Guaranteed Maximum)

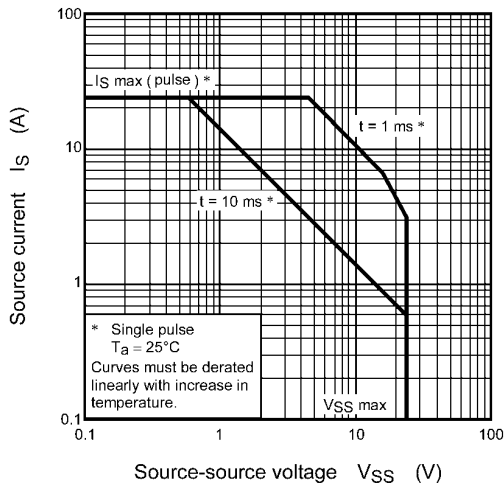
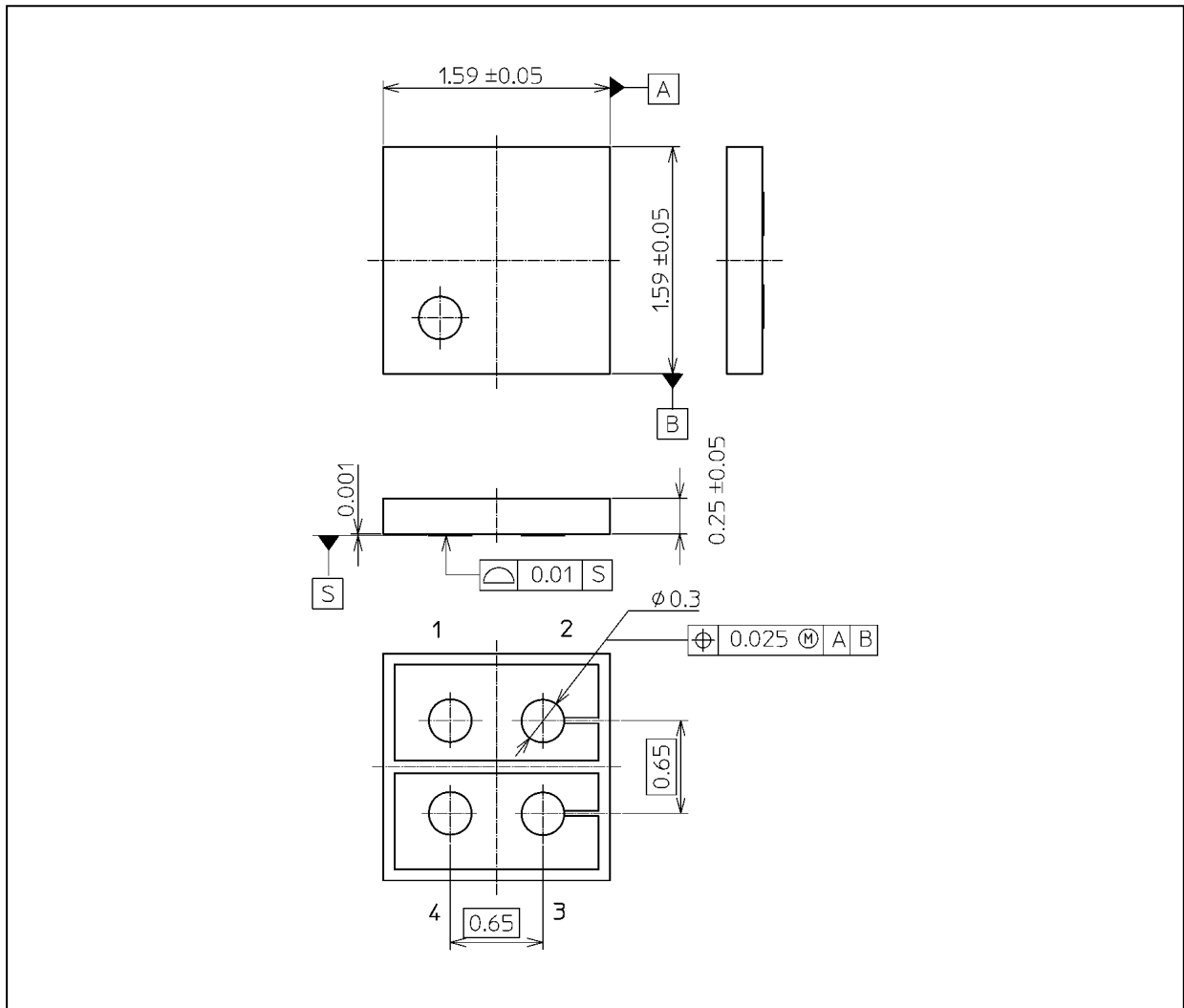

Fig. 10.13 Safe Operating Area (Note 4)
(Guaranteed Maximum)

Note: The above characteristics curves are presented for reference only and not guaranteed by production test, unless otherwise noted.

Package Dimensions

Unit: mm



Weight: 0.00147 g (typ.)

Package Name(s)
TOSHIBA: 2-2W1S
Nickname: ChipLGA

RESTRICTIONS ON PRODUCT USE

- Toshiba Corporation, and its subsidiaries and affiliates (collectively "TOSHIBA"), reserve the right to make changes to the information in this document, and related hardware, software and systems (collectively "Product") without notice.
- This document and any information herein may not be reproduced without prior written permission from TOSHIBA. Even with TOSHIBA's written permission, reproduction is permissible only if reproduction is without alteration/omission.
- Though TOSHIBA works continually to improve Product's quality and reliability, Product can malfunction or fail. Customers are responsible for complying with safety standards and for providing adequate designs and safeguards for their hardware, software and systems which minimize risk and avoid situations in which a malfunction or failure of Product could cause loss of human life, bodily injury or damage to property, including data loss or corruption. Before customers use the Product, create designs including the Product, or incorporate the Product into their own applications, customers must also refer to and comply with (a) the latest versions of all relevant TOSHIBA information, including without limitation, this document, the specifications, the data sheets and application notes for Product and the precautions and conditions set forth in the "TOSHIBA Semiconductor Reliability Handbook" and (b) the instructions for the application with which the Product will be used with or for. Customers are solely responsible for all aspects of their own product design or applications, including but not limited to (a) determining the appropriateness of the use of this Product in such design or applications; (b) evaluating and determining the applicability of any information contained in this document, or in charts, diagrams, programs, algorithms, sample application circuits, or any other referenced documents; and (c) validating all operating parameters for such designs and applications.
TOSHIBA ASSUMES NO LIABILITY FOR CUSTOMERS' PRODUCT DESIGN OR APPLICATIONS.
- Product is intended for use in general electronics applications (e.g., computers, personal equipment, office equipment, measuring equipment, industrial robots and home electronics appliances) or for specific applications as expressly stated in this document. Product is neither intended nor warranted for use in equipment or systems that require extraordinarily high levels of quality and/or reliability and/or a malfunction or failure of which may cause loss of human life, bodily injury, serious property damage or serious public impact ("Unintended Use"). Unintended Use includes, without limitation, equipment used in nuclear facilities, equipment used in the aerospace industry, medical equipment, equipment used for automobiles, trains, ships and other transportation, traffic signaling equipment, equipment used to control combustions or explosions, safety devices, elevators and escalators, devices related to electric power, and equipment used in finance-related fields. Do not use Product for Unintended Use unless specifically permitted in this document.
- Do not disassemble, analyze, reverse-engineer, alter, modify, translate or copy Product, whether in whole or in part.
- Product shall not be used for or incorporated into any products or systems whose manufacture, use, or sale is prohibited under any applicable laws or regulations.
- The information contained herein is presented only as guidance for Product use. No responsibility is assumed by TOSHIBA for any infringement of patents or any other intellectual property rights of third parties that may result from the use of Product. No license to any intellectual property right is granted by this document, whether express or implied, by estoppel or otherwise.
- **ABSENT A WRITTEN SIGNED AGREEMENT, EXCEPT AS PROVIDED IN THE RELEVANT TERMS AND CONDITIONS OF SALE FOR PRODUCT, AND TO THE MAXIMUM EXTENT ALLOWABLE BY LAW, TOSHIBA (1) ASSUMES NO LIABILITY WHATSOEVER, INCLUDING WITHOUT LIMITATION, INDIRECT, CONSEQUENTIAL, SPECIAL, OR INCIDENTAL DAMAGES OR LOSS, INCLUDING WITHOUT LIMITATION, LOSS OF PROFITS, LOSS OF OPPORTUNITIES, BUSINESS INTERRUPTION AND LOSS OF DATA, AND (2) DISCLAIMS ANY AND ALL EXPRESS OR IMPLIED WARRANTIES AND CONDITIONS RELATED TO SALE, USE OF PRODUCT, OR INFORMATION, INCLUDING WARRANTIES OR CONDITIONS OF MERCHANTABILITY, FITNESS FOR A PARTICULAR PURPOSE, ACCURACY OF INFORMATION, OR NONINFRINGEMENT.**
- Do not use or otherwise make available Product or related software or technology for any military purposes, including without limitation, for the design, development, use, stockpiling or manufacturing of nuclear, chemical, or biological weapons or missile technology products (mass destruction weapons). Product and related software and technology may be controlled under the Japanese Foreign Exchange and Foreign Trade Law and the U.S. Export Administration Regulations. Export and re-export of Product or related software or technology are strictly prohibited except in compliance with all applicable export laws and regulations.
- Please contact your TOSHIBA sales representative for details as to environmental matters such as the RoHS compatibility of Product. Please use Product in compliance with all applicable laws and regulations that regulate the inclusion or use of controlled substances, including without limitation, the EU RoHS Directive. TOSHIBA assumes no liability for damages or losses occurring as a result of noncompliance with applicable laws and regulations.