

2SD1520(L), 2SD1520(S)

SILICON NPN EPITAXIAL
MEDIUM SPEED POWER AMPLIFIER

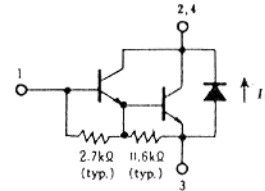
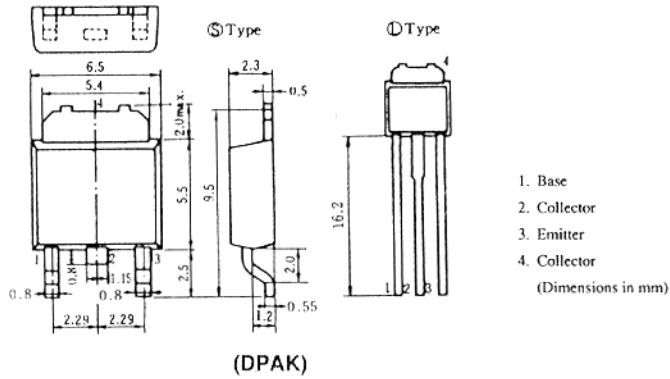

■ ABSOLUTE MAXIMUM RATINGS (Ta=25°C)

Item	Symbol	2SD1520(L), 2SD1520(S)	Unit
Collector to base voltage	V _{CB0}	100	V
Collector to emitter voltage	V _{CEO}	80	V
Emitter to base voltage	V _{EBO}	7	V
Collector current	I _C	4	A
Collector peak current	i _{C(peak)}	8	A
Collector power dissipation	P _{C*}	20	W
Junction temperature	T _j	150	°C
Storage temperature	T _{stg}	-55 to +150	°C
C to E diode forward current	I _{D*}	4	A

* Value at T_c = 25°C

■ MAXIMUM COLLECTOR DISSIPATION CURVE

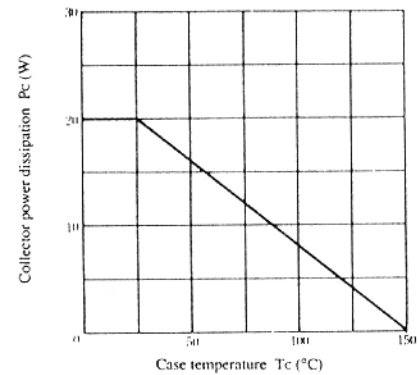

■ ELECTRICAL CHARACTERISTICS (Ta=25°C)

Item	Symbol	Test Condition	min.	typ.	max.	Unit
Collector to emitter breakdown voltage	V _{(BR)CEO}	I _C = 25mA, R _{BE} = ∞	80	—	—	V
Emitter to base breakdown voltage	V _{(BR)EBO}	I _E = 50mA, I _C = 0	7	—	—	V
Collector cutoff current	I _{CB0}	V _{CB} = 80V, I _E = 0	—	—	100	μA
	I _{CEO}	V _{CE} = 60V, R _{BE} = ∞	—	—	10	μA
DC current transfer ratio	h _{FE}	V _{CE} = 3V, I _C = 2A*	1000	—	20000	
Collector to emitter saturation voltage	V _{CE(sat)1}	I _C = 2A, I _B = 4mA*	—	—	1.5	V
	V _{CE(sat)2}	I _C = 4A, I _B = 40mA*	—	—	3.0	V
Base to emitter saturation voltage	V _{BE(sat)1}	I _C = 2A, I _B = 4mA*	—	—	2.0	V
	V _{BE(sat)2}	I _C = 4A, I _B = 40mA*	—	—	3.5	V
C to E diode forward voltage	V _D	I _D = 4A	—	—	3.0	V
Turn on time	t _{on}	I _C = 2A, I _{B1} = -I _{B2} = 4mA	—	0.5	—	μs
Storage time	t _{stg}		—	4.5	—	μs
Fall time	t _f		—	1.0	—	μs

* Pulse Test.

AREA OF SAFE OPERATION

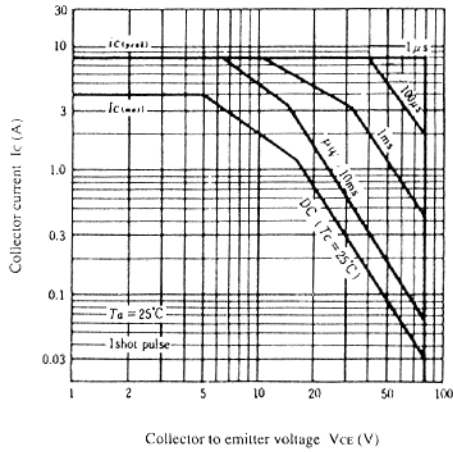

TYPICAL OUTPUT CHARACTERISTICS

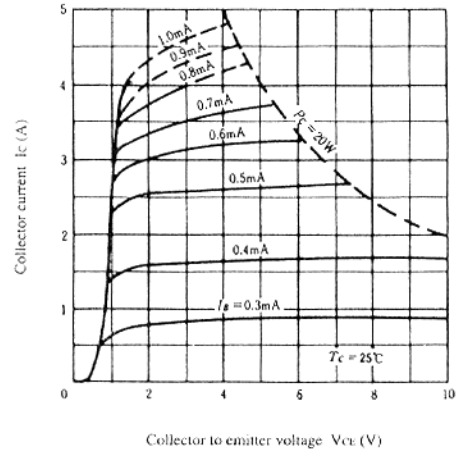

DC CURRENT TRANSFER RATIO VS. COLLECTOR CURRENT

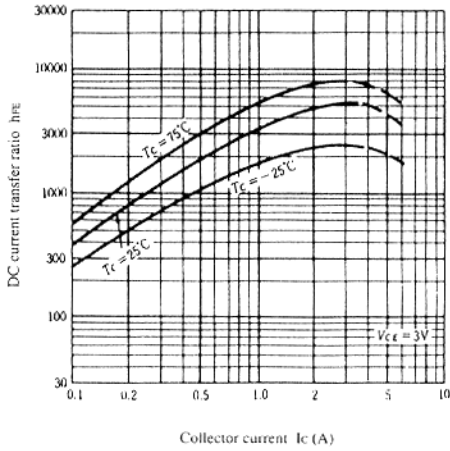

SATURATION VOLTAGE VS. COLLECTOR CURRENT

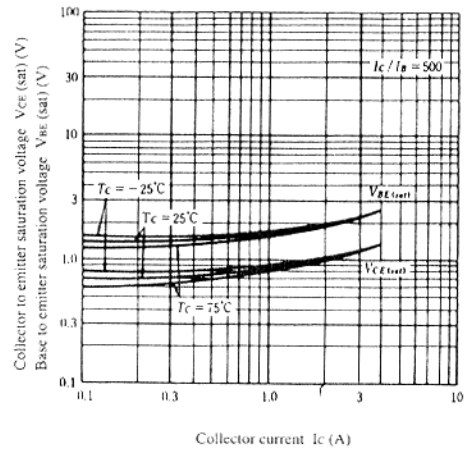

SWITCHING TIME VS. COLLECTOR CURRENT

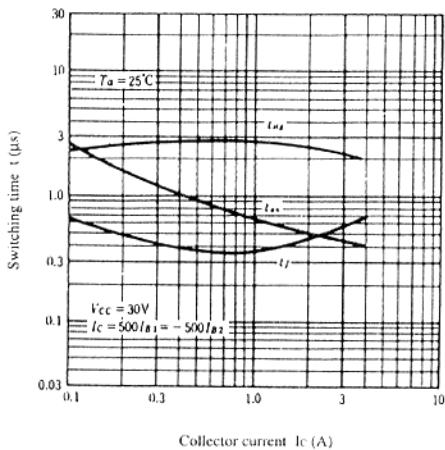

TRANSIENT THERMAL RESISTANCE

