

TA76433FC

High-Precision Shunt Regulators with Adjustable Output Voltage

Due to the increasing requirement for low power dissipation levels, 3-V power supply systems in electronic equipment are now in greater demand than conventional 5-V power supply systems. Toshiba has developed the TA76433FC, a high-precision shunt regulator with adjustable output voltage is aimed for use in even lower voltage applications.

It differs from the conventional shunt regulator (TA76431/432 series) of our company, the power supply input terminal which became separate of the cathode terminal is set up.

Since the cathode terminal of the detection side and the input terminal of the power supply side is separate, a cathode terminal can operate from 0.2 V.

It is suitable for the secondary side difference amplifier of the switching regulator of 1.8 V to 2 V class.

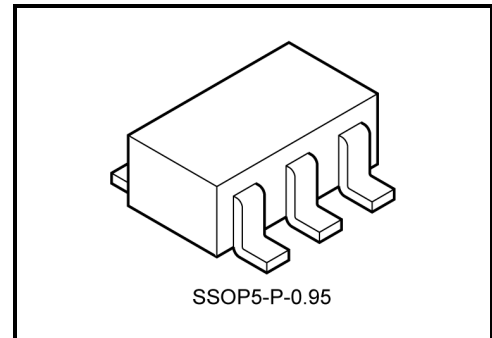

Weight: 0.014 g (typ.)

Features

- Separate power supply input pin (V_{CC}) and cathode pin (K)
- Precision reference voltage: $V_{REF} = 1.26\text{ V} \pm 1.4\%$ ($T_a = 25^\circ\text{C}$)
- Maximum cathode voltage: 15 V
- Maximum cathode current: 20 mA
- Cathode voltage: 0.2 to 14 V
- Cathode current: 0.4 to 20 mA
- Operating temperature: $T_a = -40$ to 85°C
- Packages: SMV can be mounted on a 3.1×3.0 mm space.

How to Order

Product No.	Package Type	Package Type and Capacity
TA76433FC	SMV (surface-mount type)	On cut tape (TE85L): 100/tape section
TA76433FC (TE85L)		Embossed tape (TE85L): 3000/tape section

Pin Assignment/Marking

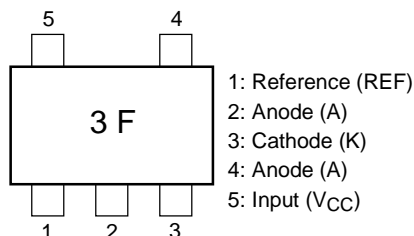

Pin No.	Symbol	Description
1	REF	Reference voltage terminal of 1.26 V
2	A	Ground terminal
3	K	Constant output voltage terminal
4	A	Ground terminal
5	V_{CC}	Power supply input terminal

Functional Block Diagram

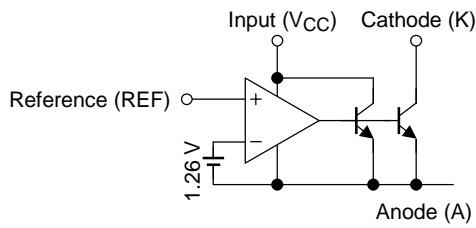

Circuit Symbol

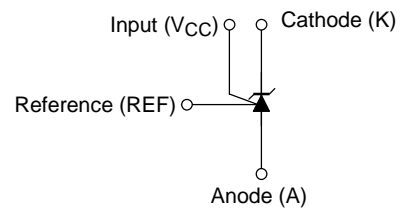

Typical Application Circuits

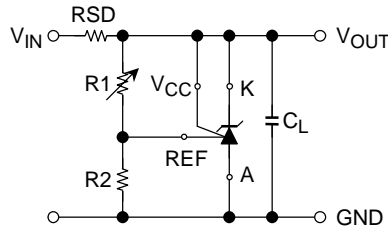

$$V_{OUT} = V_{REF} \left(1 + \frac{R1}{R2} \right) + I_{REF} \cdot R1$$

Application Circuit Example

Error amplification circuit for switching power supply

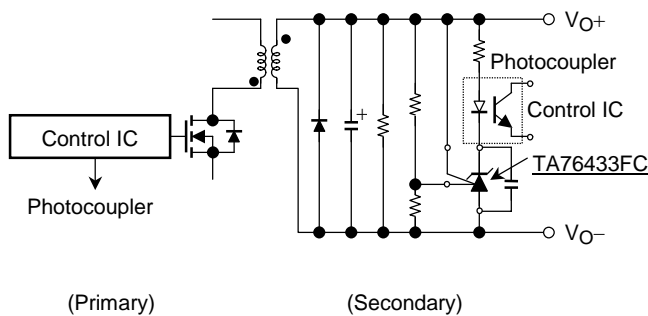

The circuit amplifies the difference (a changed value) of the reference voltage of a shunt regulator and the output voltage of a switching regulator, and is fed back to a primary side through a photocoupler.

Precautions during Use

- (1) TA76433FC
These products contain MOS elements. Please take care to avoid generating static electricity when handling these devices.
- (2) TA76433FC
The oscillation frequency of these devices is determined by the value of the capacitor connected between the anode and the cathode.
When establishing maximum operating condition parameters, please derate the maximum rating values specified in these datasheets so as to allow an operational safety margin.
- (3) Precautions when handling anode pin of TA76433FC
Pin 2 and pin 4 should normally be shorted together. Do not leave pin 4 open and use pin 2 only.

Maximum Ratings (Ta = 25°C)

Characteristics	Symbol	Rating	Unit
Power supply voltage	V _{CC}	15	V
Cathode voltage	V _{KA}	V _{CC}	V
Reference voltage	V _{REF}	7	V
Cathode current	I _K	20	mA
Cathode-anode reverse current	-I _K	10	mA
Reference current	I _{REF}	50	μA
Reference-anode reverse current	-I _{REF}	10	mA
Power supply current	I _{CC}	3	mA
Power dissipation	P _D	0.2	W
		0.38 (Note)	
Thermal resistance	R _{th}	625	°C/W
		328 (Note)	
Operating temperature	T _{opr}	-40~85	°C
Junction temperature	T _j	150	°C
Storage temperature	T _{stg}	-55~150	°C

Note: Mounted on a glass-epoxy substrate: 30 mm × 30 mm × 0.8 mm (Cu pad area 50 mm²)

Recommended Operating Conditions

Characteristics	Symbol	Min	Typ.	Max	Unit
Power supply voltage	V _{CC}	V _{REF}	—	14	V
Cathode voltage	V _{KA}	0.2	—	V _{CC}	V
Cathode current	I _K	0.4	—	15	mA
Operating temperature	T _{opr}	-40	—	85	°C

Electrical Characteristics (Unless otherwise specified, $V_{CC} = 2\text{ V}$, $I_K = 5\text{ mA}$, $T_a = 25^\circ\text{C}$)

Characteristics	Symbol	Test Condition	Min	Typ.	Max	Unit
Reference voltage	V_{REF}	$V_{KA} = V_{REF}$	1.242	1.26	1.278	V
Deviation of reference input voltage overtemperature	$V_{REF}(\text{dev})$	$0^\circ\text{C} \leq T_a \leq 85^\circ\text{C}$, $V_{KA} = V_{REF}$	—	5	15	mV
Ratio of change in reference input voltage to the change in power supply voltage	$\Delta V_{REF}/\Delta V_{CC}$	$1.8\text{ V} \leq V_{CC} \leq 15\text{ V}$	—	-0.3	-1.5	mV/V
Reference Input current	I_{REF}	$V_{KA} = V_{REF}$, $R_1 = 10\text{ k}\Omega$, $R_2 = \infty$	—	2	4	μA
Deviation of reference input current over temperature	$I_{REF}(\text{dev})$	$0^\circ\text{C} \leq T_a \leq 85^\circ\text{C}$, $V_{KA} = V_{REF}$, $R_1 = 10\text{ k}\Omega$, $R_2 = \infty$	—	0.3	1.2	μA
Minimum cathode current for regulation	I_{Kmin}	$V_{KA} = V_{REF}$	—	200	400	μA
Cathode saturation voltage	V_{Ksat}	$V_{REF} = 1.3\text{ V}$, $I_K = 5\text{ mA}$	—	0.05	0.2	V
Off-State cathode current	I_{Koff}	$V_{KA} = V_{CC} = 15\text{ V}$, $V_{REF} = 0\text{ V}$	—	—	1.0	μA
Dynamic impedance	$ Z_{KA} $	$0.4\text{ mA} \leq I_K \leq 15\text{ mA}$, $f \leq 1\text{ kHz}$	—	0.2	0.5	Ω

The deviation parameters $V_{REF}(\text{dev})$ and $I_{REF}(\text{dev})$ are defined as the maximum variation of the V_{REF} and I_{REF} over the rated temperature range.

The average temperature coefficient of the V_{REF} is defined as:

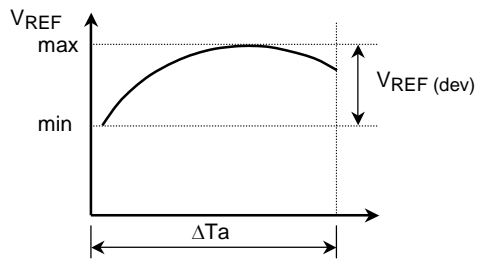

$$|\alpha V_{REF}| = \left(\frac{V_{REF}(\text{dev}) \times 10^6}{V_{REF} @ 25^\circ\text{C}} \right) \text{ (ppm/}^\circ\text{C)}$$

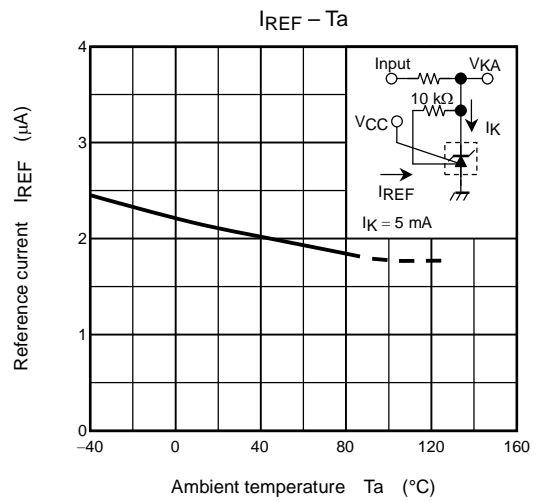
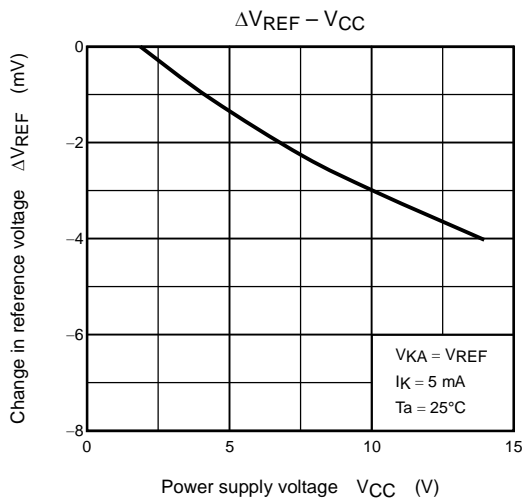
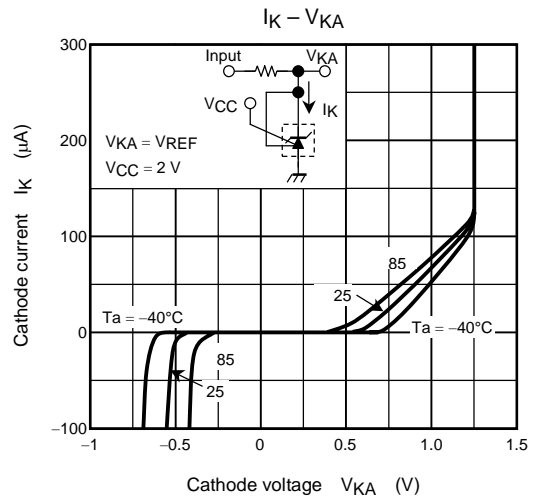
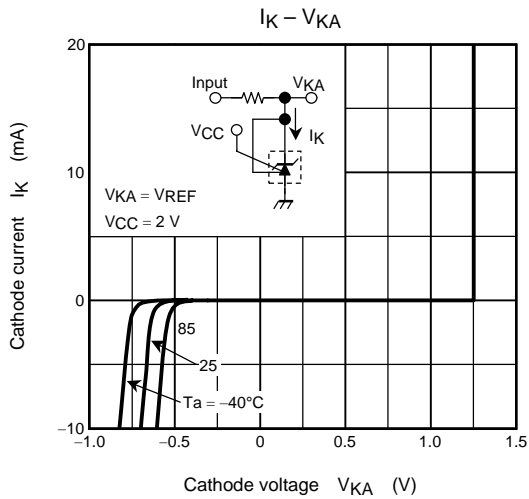
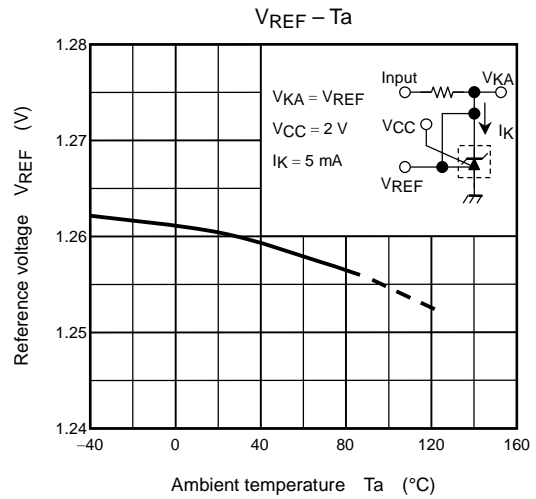
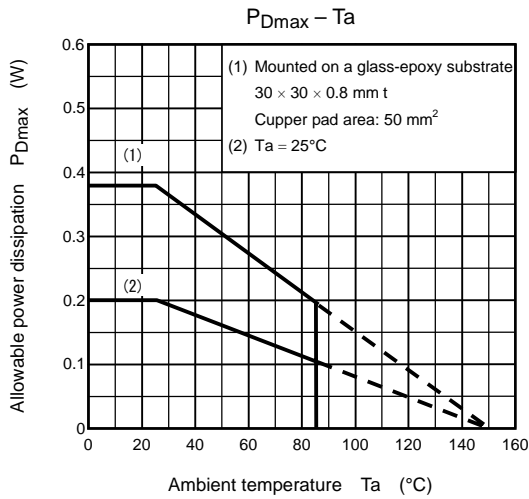

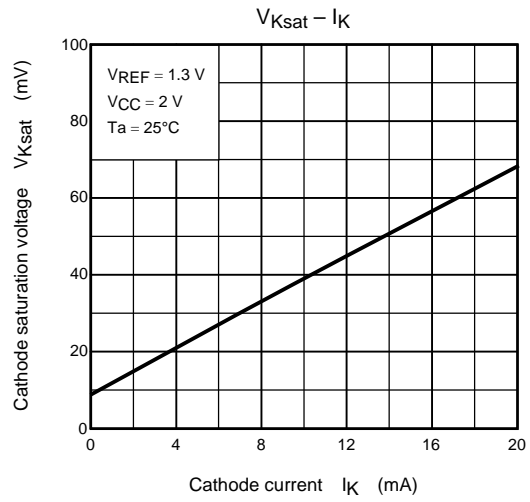
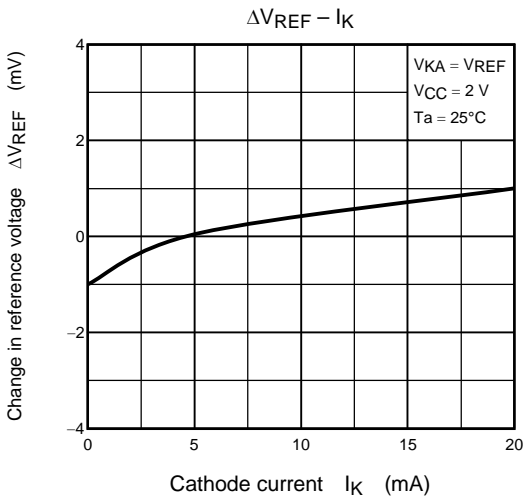
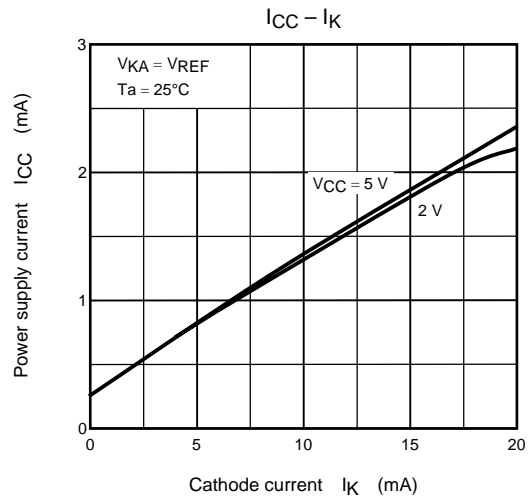
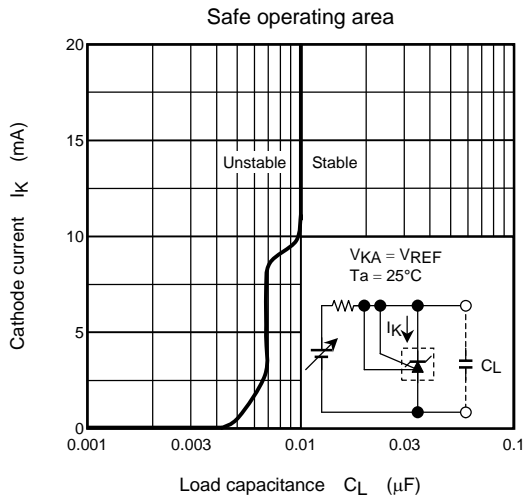

Package Dimensions

SSOP5-P-0.95

Unit : mm

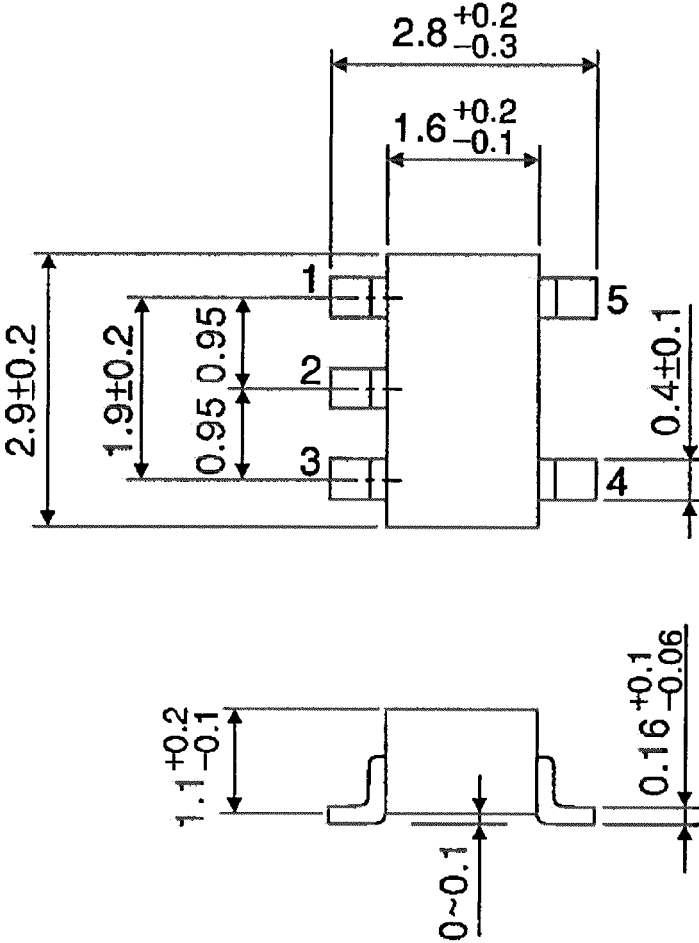

Weight: 0.014 g (typ.)

RESTRICTIONS ON PRODUCT USE

000707EBA

- TOSHIBA is continually working to improve the quality and reliability of its products. Nevertheless, semiconductor devices in general can malfunction or fail due to their inherent electrical sensitivity and vulnerability to physical stress. It is the responsibility of the buyer, when utilizing TOSHIBA products, to comply with the standards of safety in making a safe design for the entire system, and to avoid situations in which a malfunction or failure of such TOSHIBA products could cause loss of human life, bodily injury or damage to property.
In developing your designs, please ensure that TOSHIBA products are used within specified operating ranges as set forth in the most recent TOSHIBA products specifications. Also, please keep in mind the precautions and conditions set forth in the "Handling Guide for Semiconductor Devices," or "TOSHIBA Semiconductor Reliability Handbook" etc..
- The TOSHIBA products listed in this document are intended for usage in general electronics applications (computer, personal equipment, office equipment, measuring equipment, industrial robotics, domestic appliances, etc.). These TOSHIBA products are neither intended nor warranted for usage in equipment that requires extraordinarily high quality and/or reliability or a malfunction or failure of which may cause loss of human life or bodily injury ("Unintended Usage"). Unintended Usage include atomic energy control instruments, airplane or spaceship instruments, transportation instruments, traffic signal instruments, combustion control instruments, medical instruments, all types of safety devices, etc.. Unintended Usage of TOSHIBA products listed in this document shall be made at the customer's own risk.
- The products described in this document are subject to the foreign exchange and foreign trade laws.
- The information contained herein is presented only as a guide for the applications of our products. No responsibility is assumed by TOSHIBA CORPORATION for any infringements of intellectual property or other rights of the third parties which may result from its use. No license is granted by implication or otherwise under any intellectual property or other rights of TOSHIBA CORPORATION or others.
- The information contained herein is subject to change without notice.