

Features

- Ideal for 802.11b/g
- +23 dBm P1dB typical at 3.3 V
- 30 dB Gain typical
- 802.11g compliant to +16.5 dBm P_{OUT}, 3% EVM
- Micro-Amp Shutdown
- Integrated Detector
- SiGe Process: Lowest Cost Solution
- Lead-Free 2.5 X 2 mm 14-Lead PQFN Package
- Halogen-Free “Green” Mold Compound
- RoHS* Compliant and 260°C Reflow Compatible

Description

The MAAP-008516 is a three stage power amplifier, designed for WLAN applications. This power amplifier is available in a lead free 2.5 X 2 mm 14-Lead PQFN plastic package. The MAAP-008516 also features an integrated power detector, and consumes only 80 mA at -13.5 dBm input power under 802.11g modulation conditions.

Ordering Information^{1,2}

Part Number	Package
MAAP-008516-TR3000	3000 piece reel
MAAP-008516-001SMB	Sample Test Board

1. Reference Application Note M513 for reel size information.
2. All sample boards include 5 loose parts.

Functional Schematic

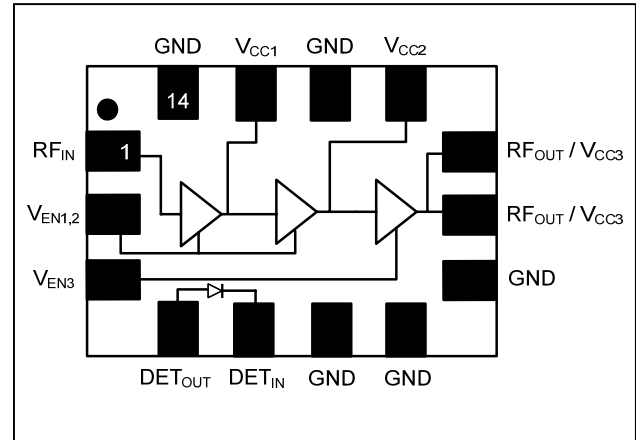

Pin Configuration

Pin No.	Pin Name	Description
1	RF _{IN}	RF Input
2	V _{EN1,2}	Power Enable
3	V _{EN3}	Power Enable
4	DET _{OUT}	Detector Output
5	DET _{IN}	Detector Input
6	GND	Ground
7	GND	Ground
8	GND	Ground
9	RF _{OUT} / V _{CC3}	RF Output, 3rd Stage Supply
10	RF _{OUT} / V _{CC3}	RF Output, 3rd Stage Supply
11	V _{CC2}	2nd Stage Supply
12	GND	Ground
13	V _{CC1}	1st Stage Supply
14	GND	Ground
Pad	Paddle ³	RF & DC Ground

3. The exposed pad centered on the package bottom must be connected to RF and DC ground.

* Restrictions on Hazardous Substances, European Union Directive 2002/95/EC.

Electrical Specifications: F = 2.45 GHz, V_{CC} = 3.3 V, V_{EN} = 2.6 V, T_A = 25°C, Z₀ = 50 Ω

Parameter	Test Conditions	Units	Min.	Typ.	Max.
Gain	—	dB	27.5	30	—
Input Return Loss	—	dB	—	15	—
Forward Isolation	—	dB	—	50	—
P1dB	—	dBm	—	23	—
Current	Idle	mA	—	55	95
	P _{IN} = -13.5 dBm, Modulated ⁴	mA	—	80	120
	P _{IN} = -13.5 dBm, C.W.	mA	60	95	110
Off Current	V _{EN} = 0 V	μA	—	3	20
Control Current	V _{EN} Current	mA	—	4.5	7
Harmonics	2fo @ -13.5 dBm Input Power	dBc	—	-33	-23
	3fo @ -13.5 dBm Input Power	dBc	—	-55	-45
Duty Cycle	—	%	—	100	—
Linear Output Power	DSS source; compliance with 802.11b EVM=3.0%, OFDM, QAM-64, 54 Mbps, 802.11g	dBm	—	21.5	—
		dBm	—	16.5	—
Detector Output	P _{IN} = -13.5 dBm, C.W.	V	—	0.65	—

4. OFDM, QAM-64, 54 Mbps

Absolute Maximum Ratings^{5,6,7}

Parameter	Absolute Maximum
Input Power	-5 dBm
Operating Supply Voltage	+4.0 Volts
Operating Control Voltage	+3.0 Volts
Operating Temperature	-20°C to +85°C
Junction Temperature ⁸	+150°C
Storage Temperature	-40°C to +150°C

- Exceeding any one or combination of these limits may cause permanent damage to this device.
- M/A-COM Technology does not recommend sustained operation near these survivability limits.
- These operating conditions will ensure MTTF > 1 x 10⁶ hours.
- Junction Temperature (T_J) = T_C + Θ_{JC} * ((V * I) - (P_{OUT} - P_{IN}))
Typical thermal resistance (Θ_{JC}) = 25° C/W.
a) For T_C = 25°C,
T_J = 31 °C @ 3.3 V, 80 mA, P_{OUT} = 16.5 dBm, P_{IN} = -13.5 dBm
b) For T_C = 85°C,
T_J = 91 °C @ 3.3 V, 90 mA, P_{OUT} = 15 dBm, P_{IN} = -13.5 dBm

Operating the MAAP-008516

The MAAP-008516 is static sensitive. Please handle with care. To operate the device, follow these steps.

- Apply V_{CC} (3.3 V).
- Apply V_{EN} (2.6 V).
- Set input power.
- Turn off in reverse order with V_{CC} last.

Recommended PCB Configuration

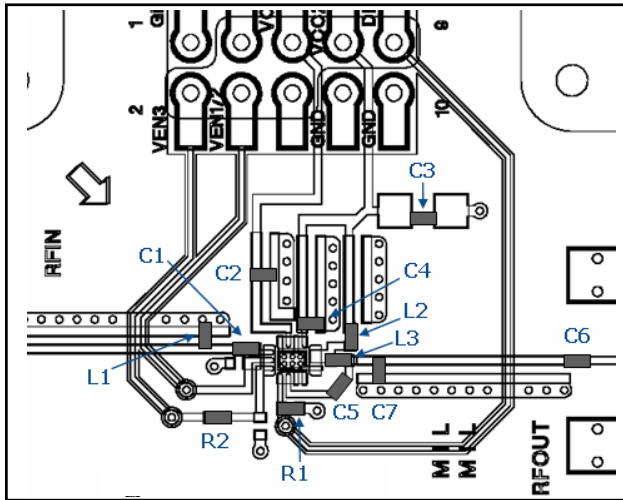

External Parts List

Component	Value	Footprint	Manufacturer
C1	2.7 pF	0402	Murata
C2	10 pF	0402	Murata
C3	1.0 μ F	0402	Murata
C4	0.1 μ F	0402	Murata
C5	.70 pF	0402	ATC High Q
C6	1000 pF	0402	Murata
C7	1.0 pF	0402	ATC High Q
L1	2.0 nH	0402	Coilcraft
L2	10.0 nH	0402	Coilcraft
L3	1.0 nH	0402	Coilcraft
R1	220K Ω	0402	Panasonic
R2	0 Ω	0402	Panasonic
TL1	50 Ω , 20.6° @ 2.45 GHz		
TL2	50 Ω , 7.4° @ 2.45 GHz		

Evaluation Board Schematic

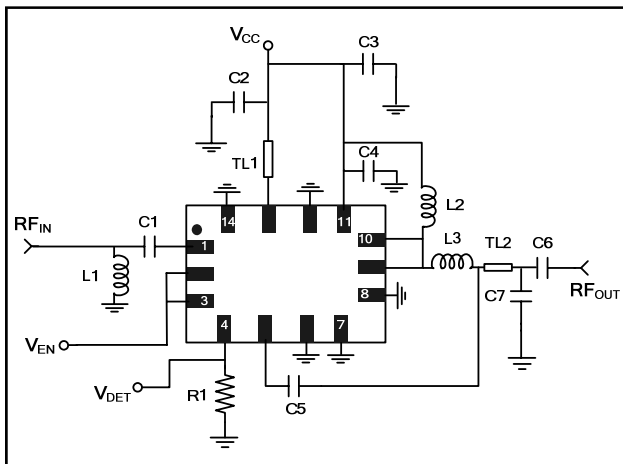

Handling Procedures

Please observe the following precautions to avoid damage:

Static Sensitivity

Proper ESD control techniques should be used when handling these Class 1B devices.

Typical Performance Curves: $V_{CC} = 3.3\text{ V}$, $V_{EN} = 2.6\text{ V}$, over Temperature

S21 vs. Frequency (2.4 GHz - 2.5 GHz) -Gain

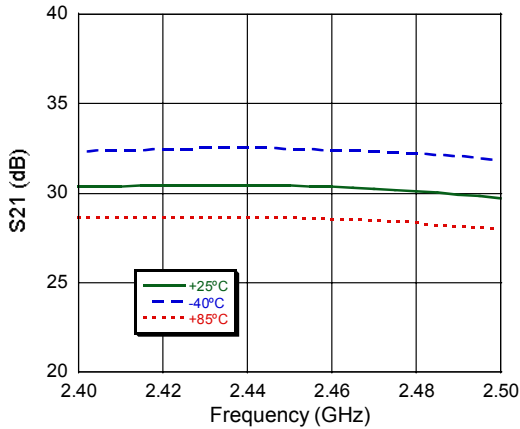

S21 vs. Frequency -Gain

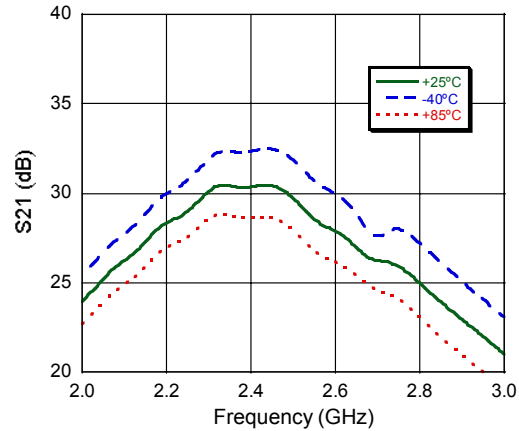

S11 vs. Frequency (2.4 GHz - 2.5 GHz)

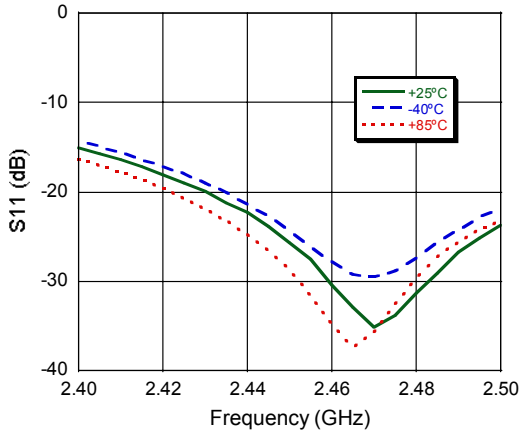

S11 vs. Frequency

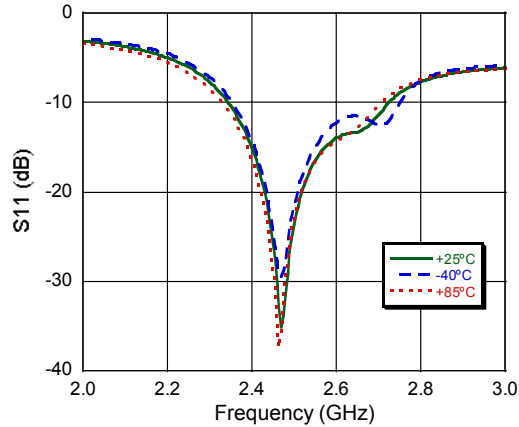

S22 vs. Frequency (2.4 GHz - 2.5 GHz)

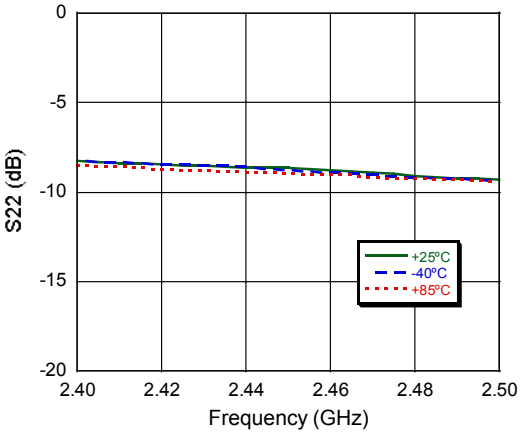

S22 vs. Frequency

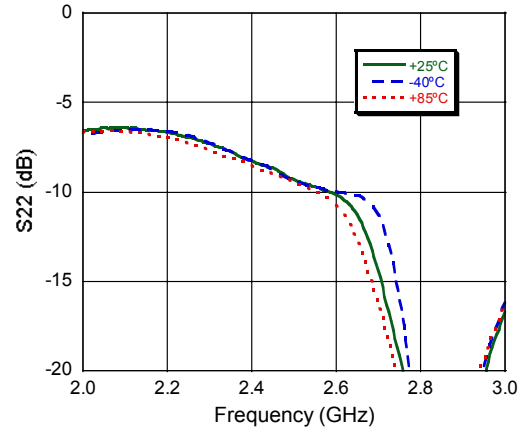

Typical Performance Curves: $V_{CC} = 3.3\text{ V}$, $V_{EN} = 2.6\text{ V}$

P_{1dB} @ 2.4 - 2.5 GHz

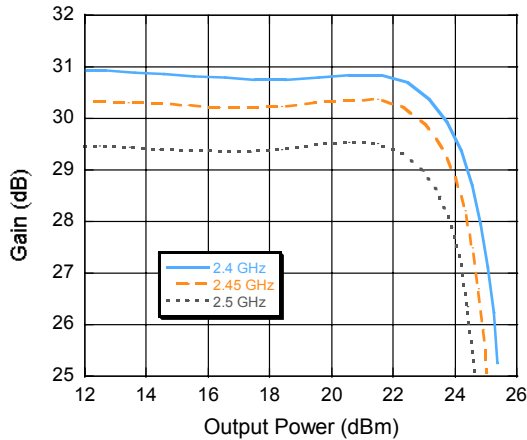

EVM vs. P_{OUT} @ 2.4 - 2.5 GHz, OFDM, QAM-64, 54 Mbps

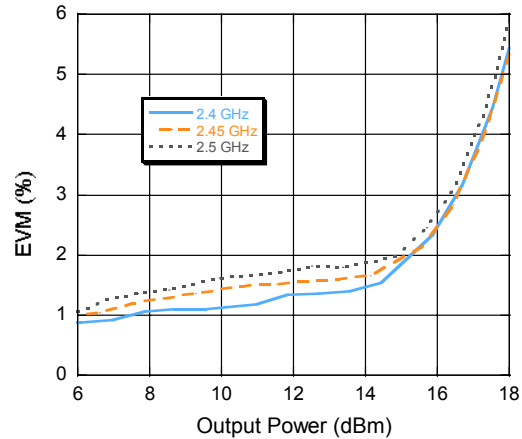

Modulated Current vs. P_{OUT} over Temperature @ 2.45 GHz

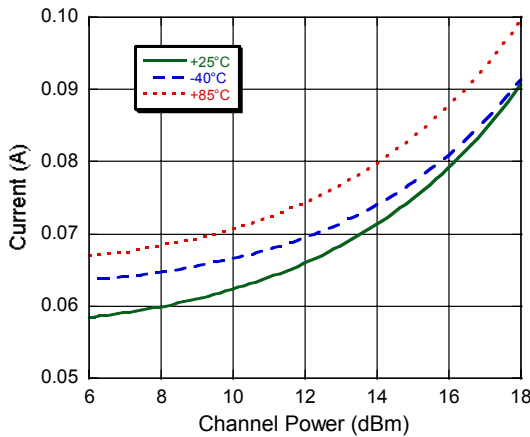

V_{DET} vs. P_{OUT} over Temperature @ 2.45 GHz

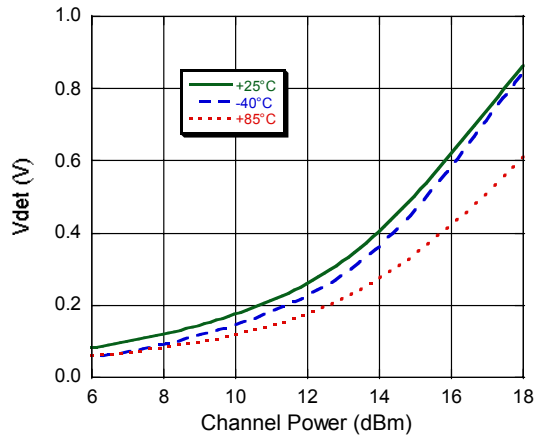

Typical Performance Curves: $V_{CC} = 3.3\text{ V}$, $V_{EN} = 2.6\text{ V}$

802.11b Spectrum Emission Mask @ 2.45 GHz

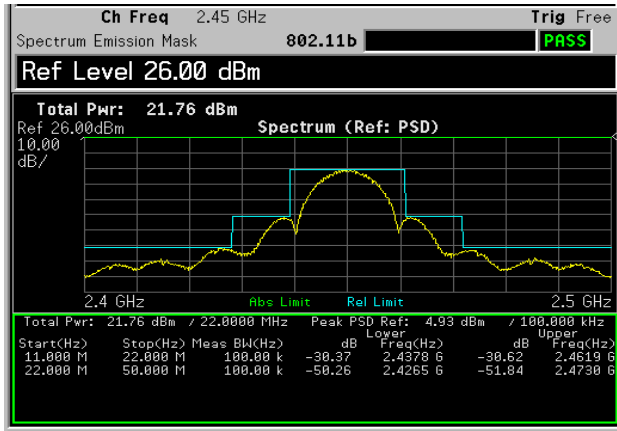

EVM vs. P_{OUT} over Temperature @ 2.45 GHz, OFDM, QAM-64, 54 Mbps⁹

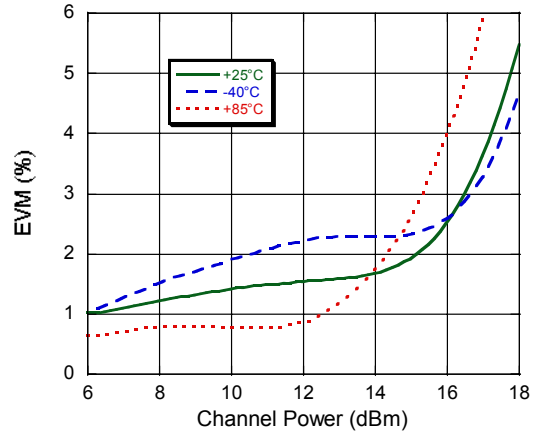

9. Includes system level EVM of 0.7%

Lead-Free 2.5 x 2 mm 14-Lead PQFN†

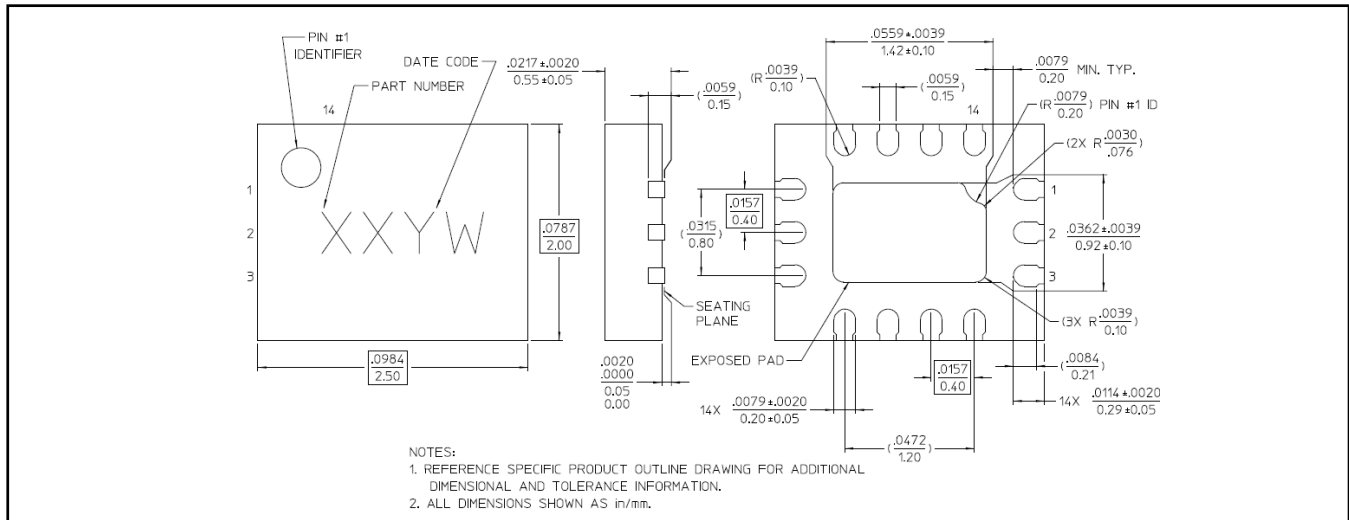

† Reference Application Note S2083 for lead-free solder reflow recommendations.

Meets JEDEC moisture sensitivity level 1 requirements.

Plating is 100% matte tin over copper.