

General Purpose Transistors

PNP Silicon

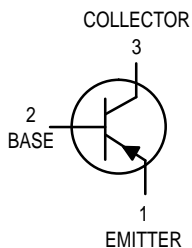

MPS2907
MPS2907A*

*Motorola Preferred Device

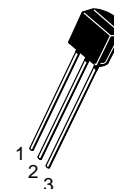

CASE 29-04, STYLE 1
TO-92 (TO-226AA)

MAXIMUM RATINGS

Rating	Symbol	MPS2907	MPS2907A	Unit
Collector–Emitter Voltage	V_{CEO}	-40	-60	Vdc
Collector–Base Voltage	V_{CBO}	-60		Vdc
Emitter–Base Voltage	V_{EBO}	-5.0		Vdc
Collector Current — Continuous	I_C	-600		mAdc
Total Device Dissipation @ $T_A = 25^\circ\text{C}$ Derate above 25°C	P_D	625	5.0	mW mW/°C
Total Device Dissipation @ $T_C = 25^\circ\text{C}$ Derate above 25°C	P_D	1.5	12	Watts mW/°C
Operating and Storage Junction Temperature Range	T_J, T_{stg}	-500 to +150		°C

THERMAL CHARACTERISTICS

Characteristic	Symbol	Max	Unit
Thermal Resistance, Junction to Ambient	$R_{\theta JA}$	200	°C/W
Thermal Resistance, Junction to Case	$R_{\theta JC}$	83.3	°C/W

ELECTRICAL CHARACTERISTICS ($T_A = 25^\circ\text{C}$ unless otherwise noted)

Characteristic	Symbol	Min	Max	Unit
OFF CHARACTERISTICS				
Collector–Emitter Breakdown Voltage ⁽¹⁾ ($I_C = -10$ mAdc, $I_B = 0$)	$V_{(BR)CEO}$	-40 -60	— —	Vdc
Collector–Base Breakdown Voltage ($I_C = -10$ μ Adc, $I_E = 0$)	$V_{(BR)CBO}$	-60	—	Vdc
Emitter–Base Breakdown Voltage ($I_E = -10$ μ Adc, $I_C = 0$)	$V_{(BR)EBO}$	-5.0	—	Vdc
Collector Cutoff Current ($V_{CE} = -30$ Vdc, $V_{EB(off)} = -0.5$ Vdc)	I_{CEX}	—	-50	nAdc
Collector Cutoff Current ($V_{CB} = -50$ Vdc, $I_E = 0$)	I_{CBO}	—	-0.02	μ Adc
($V_{CB} = -50$ Vdc, $I_E = 0, T_A = 150^\circ\text{C}$)		—	-0.01	
		—	-20	
		—	-10	
Base Current ($V_{CE} = -30$ Vdc, $V_{EB(off)} = -0.5$ Vdc)	I_B	—	-50	nAdc

1. Pulse Test: Pulse Width ≤ 300 μ s, Duty Cycle $\leq 2.0\%$.

Preferred devices are Motorola recommended choices for future use and best overall value.

MPS2907 MPS2907A

ELECTRICAL CHARACTERISTICS (T_A = 25°C unless otherwise noted) (Continued)

Characteristic	Symbol	Min	Max	Unit
ON CHARACTERISTICS				
DC Current Gain (I _C = -0.1 mAdc, V _{CE} = -10 Vdc)	h _{FE}	MPS2907	35	—
		MPS2907A	75	—
(I _C = -1.0 mAdc, V _{CE} = -10 Vdc)		MPS2907	50	—
		MPS2907A	100	—
(I _C = -10 mAdc, V _{CE} = -10 Vdc)		MPS2907	75	—
	MPS2907A	100	—	
(I _C = -150 mAdc, V _{CE} = -10 Vdc) ⁽¹⁾	MPS2907, MPS2907A	100	300	
(I _C = -500 mAdc, V _{CE} = -10 Vdc) ⁽¹⁾		MPS2907	30	—
		MPS2907A	50	—
Collector–Emitter Saturation Voltage ⁽¹⁾ (I _C = -150 mAdc, I _B = -15 mAdc)	V _{CE(sat)}	—	-0.4	Vdc
(I _C = -500 mAdc, I _B = -50 mAdc)		—	-1.6	
Base–Emitter Saturation Voltage ⁽¹⁾ (I _C = -150 mAdc, I _B = -15 mAdc)	V _{BE(sat)}	—	-1.3	Vdc
(I _C = -500 mAdc, I _B = -50 mAdc)		—	-2.6	

SMALL-SIGNAL CHARACTERISTICS

Current–Gain — Bandwidth Product ^{(1), (2)} (I _C = -50 mAdc, V _{CE} = -20 Vdc, f = 100 MHz)	f _T	200	—	MHz
Output Capacitance (V _{CB} = -10 Vdc, I _E = 0, f = 1.0 MHz)	C _{obo}	—	8.0	pF
Input Capacitance (V _{EB} = -2.0 Vdc, I _C = 0, f = 1.0 MHz)	C _{ibo}	—	30	pF

SWITCHING CHARACTERISTICS

Turn-On Time	(V _{CC} = -30 Vdc, I _C = -150 mAdc, I _{B1} = -15 mAdc) (Figures 1 and 5)	t _{on}	—	45	ns
Delay Time		t _d	—	10	ns
Rise Time		t _r	—	40	ns
Turn-Off Time	(V _{CC} = -6.0 Vdc, I _C = -150 mAdc, I _{B1} = I _{B2} = 15 mAdc) (Figure 2)	t _{off}	—	100	ns
Storage Time		t _s	—	80	ns
Fall Time		t _f	—	30	ns

1. Pulse Test: Pulse Width ≤ 300 μs, Duty Cycle ≤ 2.0%.
2. f_T is defined as the frequency at which |h_{fe}| extrapolates to unity.

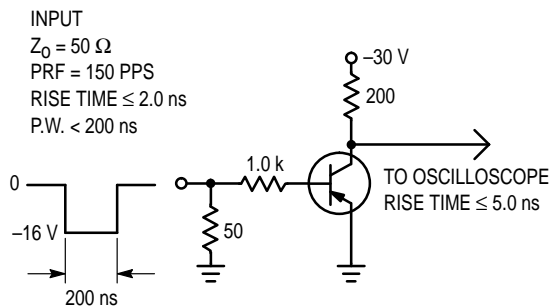

Figure 1. Delay and Rise Time Test Circuit

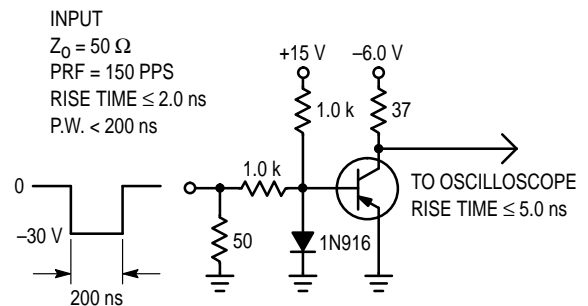

Figure 2. Storage and Fall Time Test Circuit

TYPICAL CHARACTERISTICS

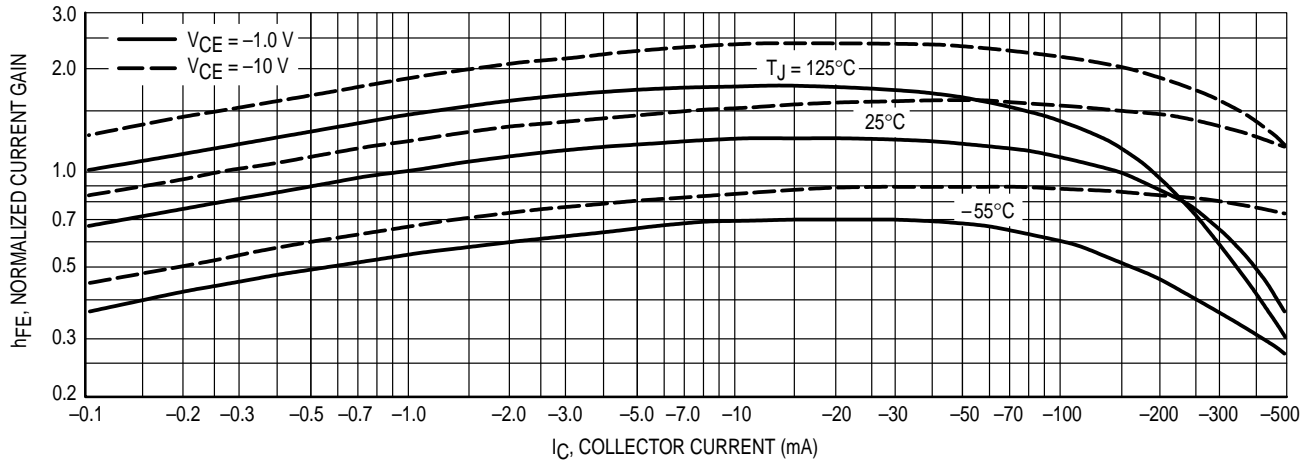

Figure 3. DC Current Gain

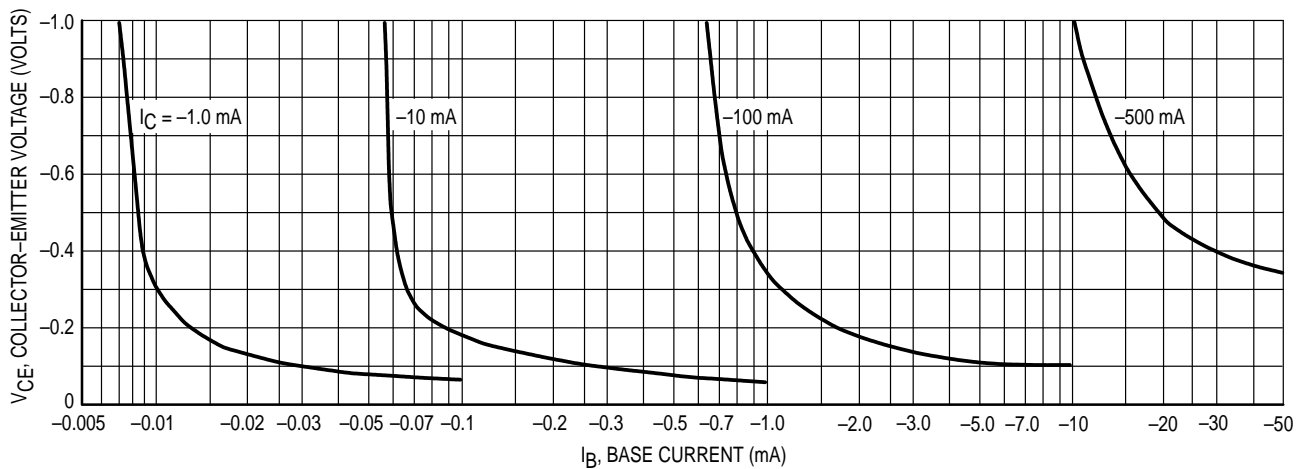

Figure 4. Collector Saturation Region

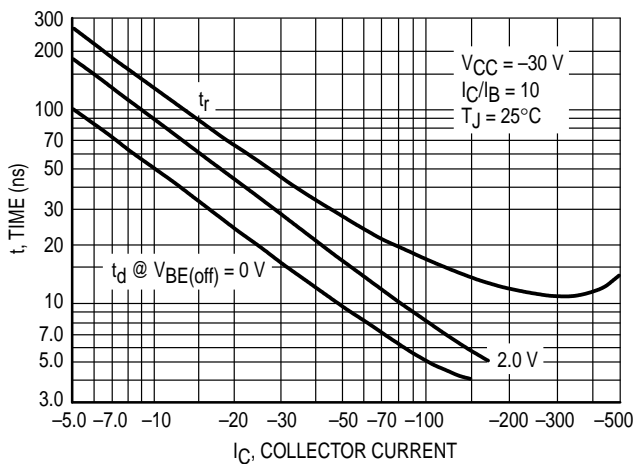

Figure 5. Turn-On Time

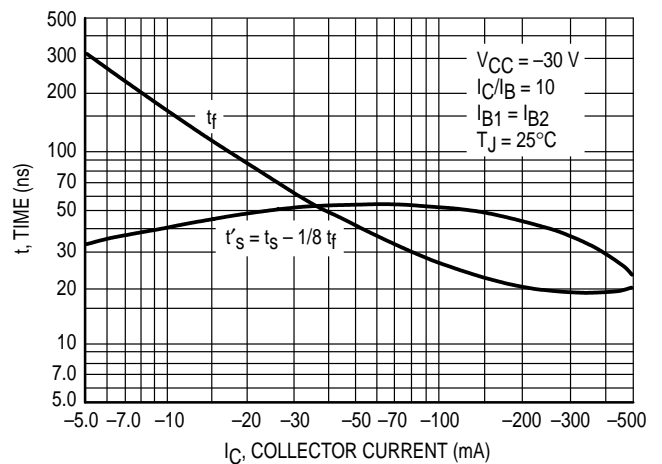

Figure 6. Turn-Off Time

TYPICAL SMALL-SIGNAL CHARACTERISTICS

NOISE FIGURE

$V_{CE} = 10 \text{ Vdc}$, $T_A = 25^\circ\text{C}$

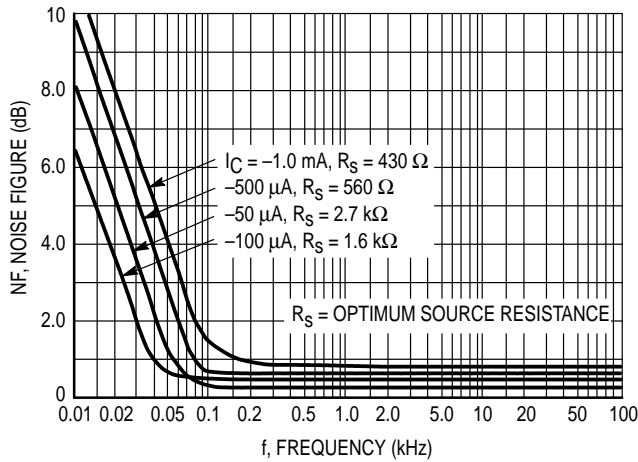

Figure 7. Frequency Effects

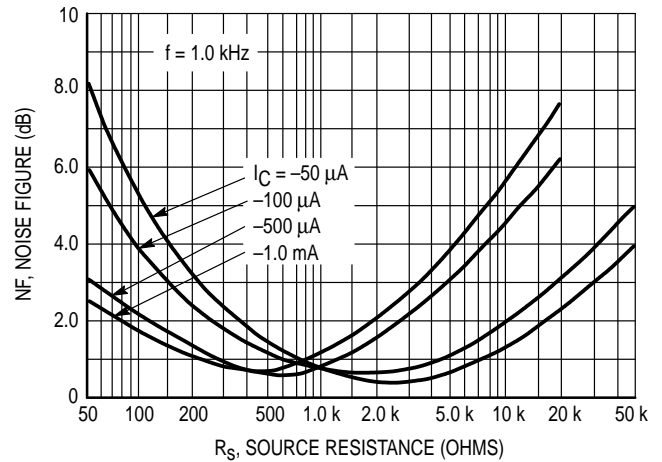

Figure 8. Source Resistance Effects

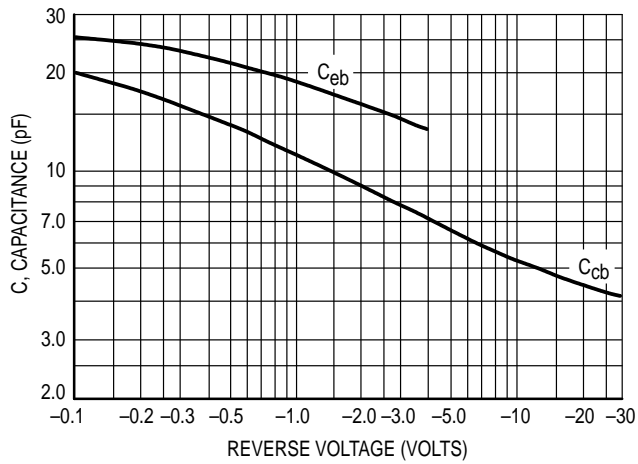

Figure 9. Capacitances

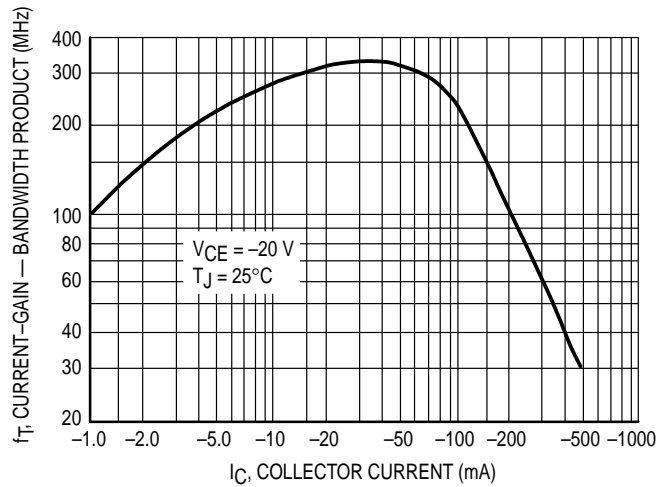

Figure 10. Current-Gain — Bandwidth Product

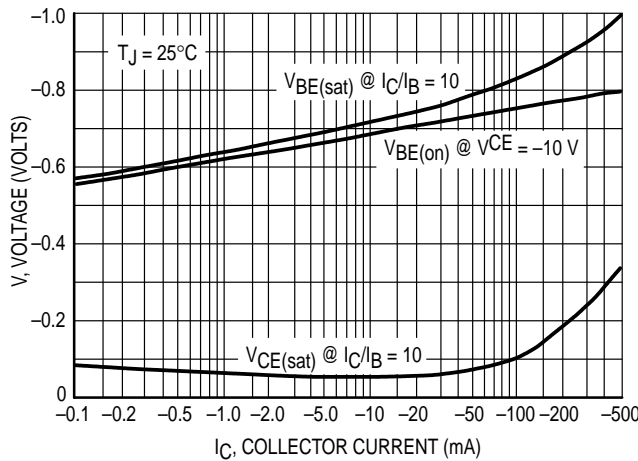

Figure 11. "On" Voltage

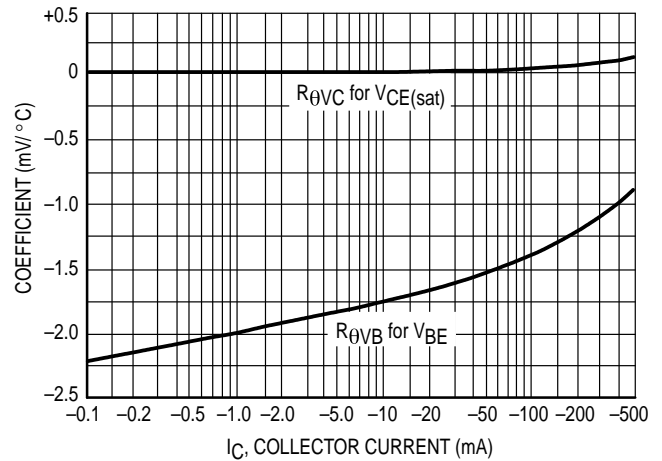
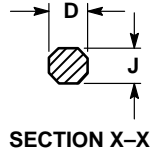
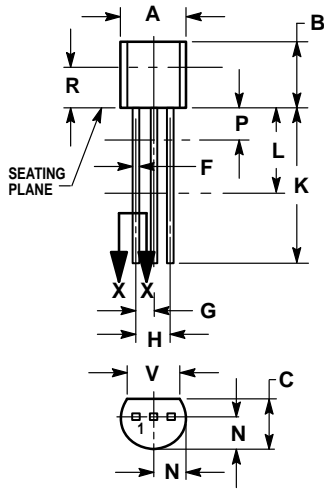

Figure 12. Temperature Coefficients

PACKAGE DIMENSIONS



SECTION X-X

CASE 029-04
(TO-226AA)
ISSUE AD

NOTES:

1. DIMENSIONING AND TOLERANCING PER ANSI Y14.5M, 1982.
2. CONTROLLING DIMENSION: INCH.
3. CONTOUR OF PACKAGE BEYOND DIMENSION R IS UNCONTROLLED.
4. DIMENSION F APPLIES BETWEEN P AND L. DIMENSION D AND J APPLY BETWEEN L AND K. MINIMUM LEAD DIMENSION IS UNCONTROLLED IN P AND BEYOND DIMENSION K MINIMUM.

DIM	INCHES		MILLIMETERS	
	MIN	MAX	MIN	MAX
A	0.175	0.205	4.45	5.20
B	0.170	0.210	4.32	5.33
C	0.125	0.165	3.18	4.19
D	0.016	0.022	0.41	0.55
F	0.016	0.019	0.41	0.48
G	0.045	0.055	1.15	1.39
H	0.095	0.105	2.42	2.66
J	0.015	0.020	0.39	0.50
K	0.500	—	12.70	—
L	0.250	—	6.35	—
N	0.080	0.105	2.04	2.66
P	—	0.100	—	2.54
R	0.115	—	2.93	—
V	0.135	—	3.43	—

STYLE 1:

- PIN 1. EMITTER
2. BASE
3. COLLECTOR

Motorola reserves the right to make changes without further notice to any products herein. Motorola makes no warranty, representation or guarantee regarding the suitability of its products for any particular purpose, nor does Motorola assume any liability arising out of the application or use of any product or circuit, and specifically disclaims any and all liability, including without limitation consequential or incidental damages. "Typical" parameters which may be provided in Motorola data sheets and/or specifications can and do vary in different applications and actual performance may vary over time. All operating parameters, including "Typicals" must be validated for each customer application by customer's technical experts. Motorola does not convey any license under its patent rights nor the rights of others. Motorola products are not designed, intended, or authorized for use as components in systems intended for surgical implant into the body, or other applications intended to support or sustain life, or for any other application in which the failure of the Motorola product could create a situation where personal injury or death may occur. Should Buyer purchase or use Motorola products for any such unintended or unauthorized application, Buyer shall indemnify and hold Motorola and its officers, employees, subsidiaries, affiliates, and distributors harmless against all claims, costs, damages, and expenses, and reasonable attorney fees arising out of, directly or indirectly, any claim of personal injury or death associated with such unintended or unauthorized use, even if such claim alleges that Motorola was negligent regarding the design or manufacture of the part. Motorola and  are registered trademarks of Motorola, Inc. Motorola, Inc. is an Equal Opportunity/Affirmative Action Employer.

How to reach us:

USA/EUROPE/Locations Not Listed: Motorola Literature Distribution;
P.O. Box 20912; Phoenix, Arizona 85036. 1-800-441-2447 or 602-303-5454

JAPAN: Nippon Motorola Ltd.; Tatsumi-SPD-JLDC, 6F Seibu-Butsuryu-Center,
3-14-2 Tatsumi Koto-Ku, Tokyo 135, Japan. 03-81-3521-8315

MFAX: RMFAX0@email.sps.mot.com – TOUCHTONE 602-244-6609
INTERNET: <http://Design-NET.com>

ASIA/PACIFIC: Motorola Semiconductors H.K. Ltd.; 8B Tai Ping Industrial Park,
51 Ting Kok Road, Tai Po, N.T., Hong Kong. 852-26629298

